

CATÁLOGO TÉCNICO

Renoir 2.2

SISTEMAS DE ESQUADRIAS DESLIZANTES



Sumário interativo

Clique para ser direcionado a página correspondente

1. Tipologias.....	07
2. Cálculo Estrutural.....	12
Dimensionamento e Fórmulas	
3. Perfis.....	46
4. Componentes.....	69
Imagens / Descrições	
5. Fichas Técnicas.....	111
Montagens / Tabelas	
6. Detalhes Construtivos.....	268
Montagens	
7. Usinagens.....	312
Aplicações	



O GRUPO CDA METAIS

Atua no desenvolvimento de sistemas de esquadrias e fachadas, extrusão, pintura eletrostática e distribuição de alumínio para todo o Brasil.

CENTROS COMERCIAIS



DIADEMA - SP



PORTO ALEGRE - RS



CURITIBA - PR

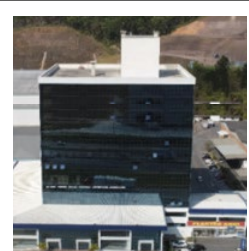

CAMBORIÚ - SC

FÁBRICAS



COLATINA - ES



ITAPEVA - MG



CANDEIAS - BA

NOSSOS PRODUTOS

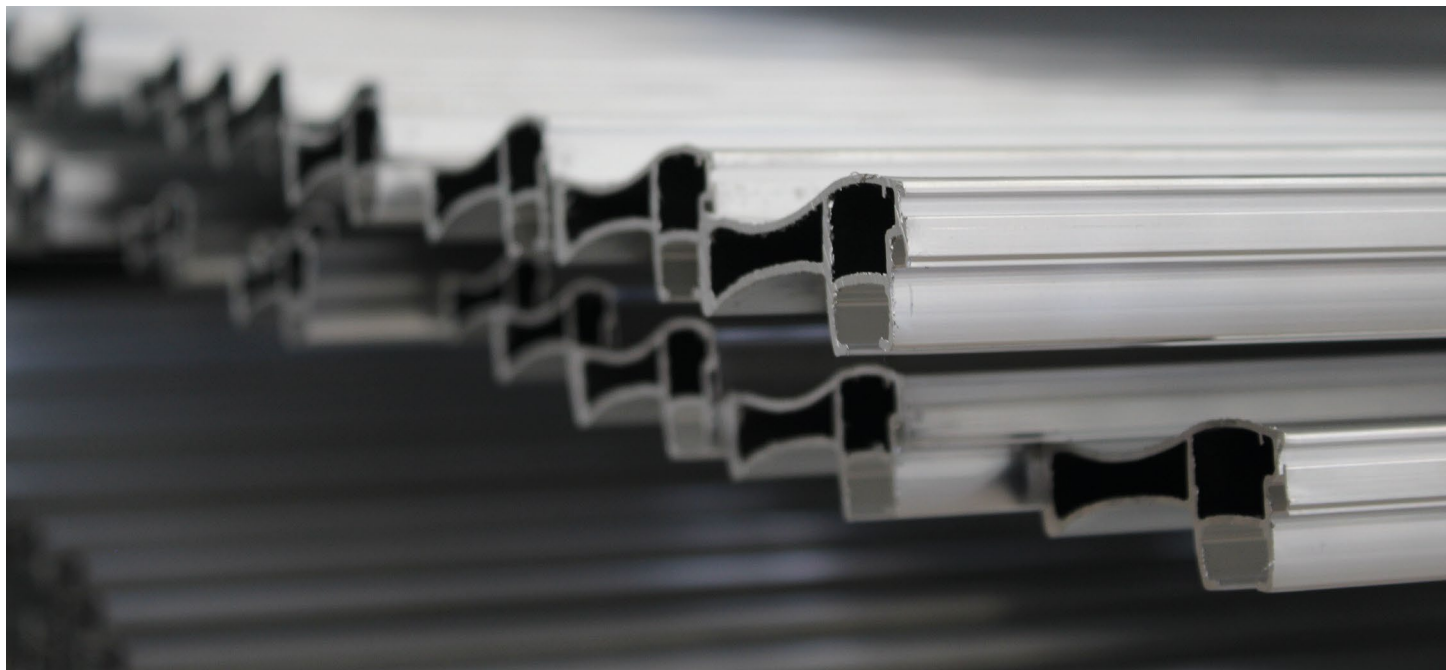

NBR 10.821 **NBR 15.575** **NBR 14.718**

Sistemas homologados que combinam tecnologia, design e alto desempenho!



DESEMPENHO
ACÚSTICO



DESEMPENHO
ESTRUTURAL



PERMEABILIDADE
AO AR



ESTANQUEIDADE
À ÁGUA

CAPACIDADE PRODUTIVA



O grupo CDA Metais conta com **4 prensas de extrusão** de tecnologia italiana, sendo três de 7 polegadas com 1800 toneladas métricas de força, e uma de 10 polegadas com 3.300 toneladas métricas.

3.500

TONELADAS MENSAS
DE EXTRUSÃO

Com isso, o parque fabril da CDA possui capacidade de **3.500 toneladas mensais de extrusão** de perfis de alumínio.

PINTURA ELETROSTÁTICA

O Grupo CDA Metais possui linhas de pintura vertical e horizontal com tecnologia de pintura a disco e pistolas convencionais, garantindo uma camada uniforme de poliéster e maior reaproveitamento de resíduos de pó. Em parceria com fornecedores, desenvolveram um processo de lavagem isento de cromo e um sistema de desengraxe e desoxidação ácido, eliminando o uso de produtos alcalinos.



Todas as modificações realizadas nas linhas de pintura foram acompanhadas e validadas pelos nossos fornecedores de produtos químicos e de tinta, os quais possuem os seus processos homologados pela Qualicoat. Dessa forma, possuímos o certificado de Aplicador Homologado com base na Norma Qualicoat 15ª Edição, dentro do Programa EAS (Epristinta Architectural Service).

 **2.200** TONELADAS MENSAIS DE PINTURA ELETROSTÁTICA

ISO 9001
ISO 14001

BUREAU VERITAS
Certification



1

Tipologias

TIPOLOGIAS

JC200
JANELA DE CORRER 2 FOLHAS

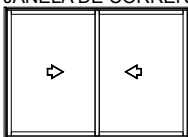

JC400
JANELA DE CORRER 4 FOLHAS

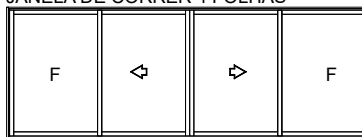

JC201
JANELA DE CORRER 2 FOLHAS COM BANDEIRA FIXA

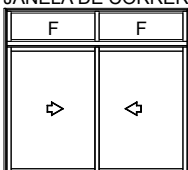

JC401
JANELA DE CORRER 4 FOLHAS COM BANDEIRA FIXA

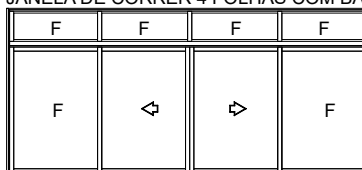

JC202
JANELA DE CORRER 2 FOLHAS COM PEITORIL FIXO

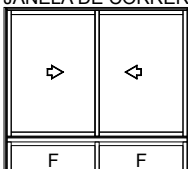

JC402
JANELA DE CORRER 4 FOLHAS COM PEITORIL FIXO

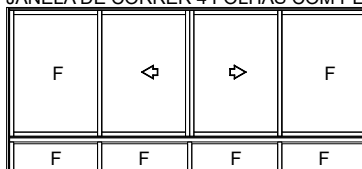

* Peitoril não tem função de guarda corpo para essa tipologia

* Peitoril não tem função de guarda corpo para essa tipologia

JC203
JANELA DE CORRER 2 FOLHAS COM PEITORIL E BANDEIRA FIXOS

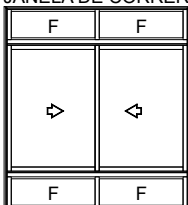

JC403
JANELA DE CORRER 4 FOLHAS COM PEITORIL E BANDEIRA FIXOS

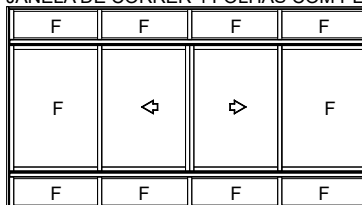

* Peitoril não tem função de guarda corpo para essa tipologia

* Peitoril não tem função de guarda corpo para essa tipologia

JC300VZ
JANELA DE CORRER 3 FOLHAS COM VENEZIANA

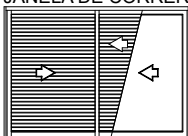

JC600VZ
JANELA DE CORRER 6 FOLHAS COM VENEZIANA

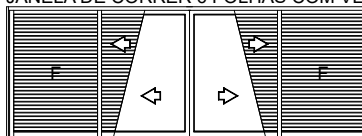

IJC200
JANELA DE CORRER 2 FOLHAS COM PERSIANA INTEGRADA

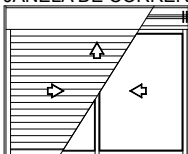

IJC202
JANELA DE CORRER 2 FOLHAS COM PEITORIL FIXO COM PERSIANA INTEGRADA

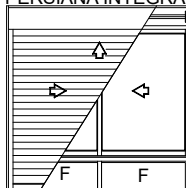

* Peitoril não tem função de guarda corpo para essa tipologia

TIPOLOGIAS

JC300
JANELA DE CORRER 3 FOLHAS

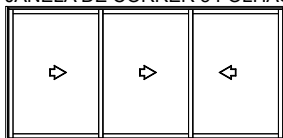

JC600
JANELA DE CORRER 6 FOLHAS

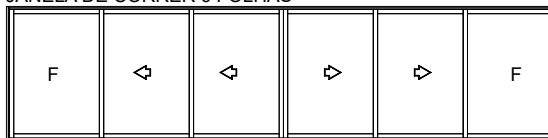

JC301
JANELA DE CORRER 3 FOLHAS COM BANDEIRA FIXA

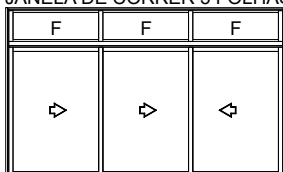

JC601
JANELA DE CORRER 6 FOLHAS COM BANDEIRA FIXA

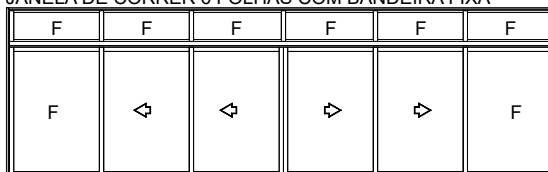

JC302
JANELA DE CORRER 3 FOLHAS COM PEITORIL FIXO

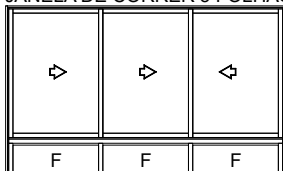

* Peitoril não tem função de guarda corpo para essa tipologia

JC602
JANELA DE CORRER 6 FOLHAS COM PEITORIL FIXO

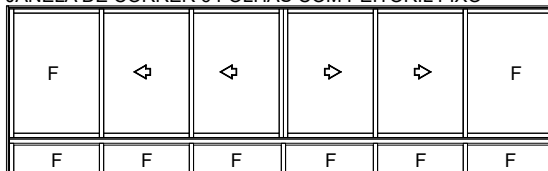

* Peitoril não tem função de guarda corpo para essa tipologia

JC303
JANELA DE CORRER 3 FOLHAS COM PEITORIL E BANDEIRA FIXOS

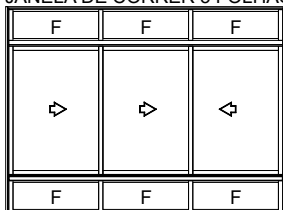

* Peitoril não tem função de guarda corpo para essa tipologia

JC603
JANELA DE CORRER 6 FOLHAS COM PEITORIL E BANDEIRA FIXOS

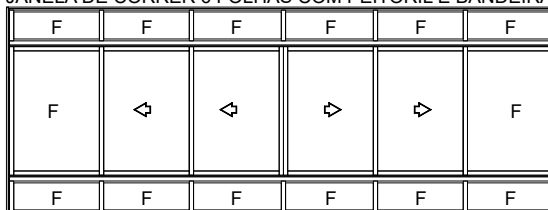

* Peitoril não tem função de guarda corpo para essa tipologia

IJC400
JANELA DE CORRER 4 FOLHAS COM PERSIANA INTEGRADA

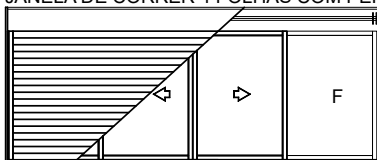

IJC400
JANELA DE CORRER 4 FOLHAS COM PERSIANA INTEGRADA COM PEITORIL FIXO

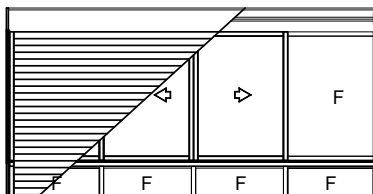

TIPOLOGIAS

PC200
PORTA DE CORRER 2 FOLHAS

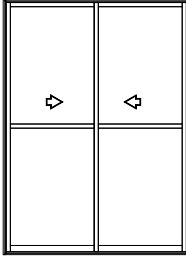

* Solução com travessa ou sem travessa

PC400
PORTA DE CORRER 4 FOLHAS

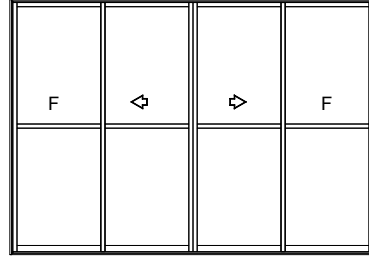

* Solução com travessa ou sem travessa

PC201
PORTA DE CORRER 2 FOLHAS COM BANDEIRA FIXA

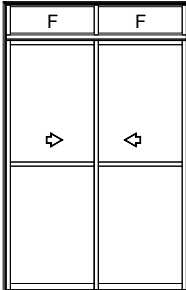

* Solução com travessa ou sem travessa

PC401
PORTA DE CORRER 4 FOLHAS COM BANDEIRA FIXA

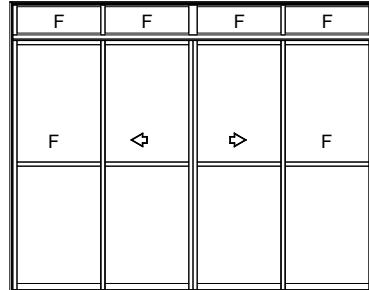

* Solução com travessa ou sem travessa

PC300
PORTA DE CORRER 3 FOLHAS

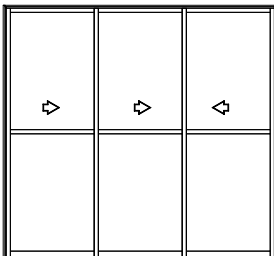

* Solução com travessa ou sem travessa

PC600
PORTA DE CORRER 6 FOLHAS

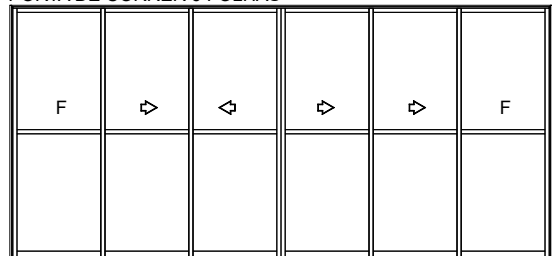

* Solução com travessa ou sem travessa

PC301
PORTA DE CORRER 3 FOLHAS COM BANDEIRA FIXA

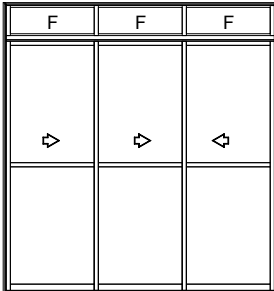

* Solução com travessa ou sem travessa

PC601
PORTA DE CORRER 6 FOLHAS COM BANDEIRA FIXA

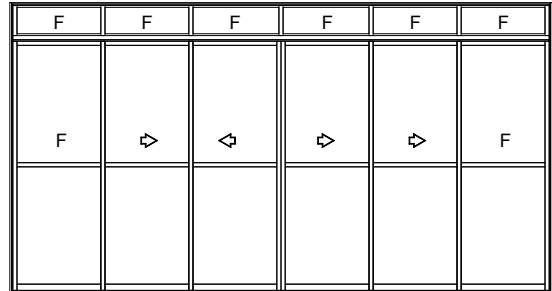

* Solução com travessa ou sem travessa

PC300VZ
PORTA DE CORRER 3 FOLHAS COM VENEZIANA

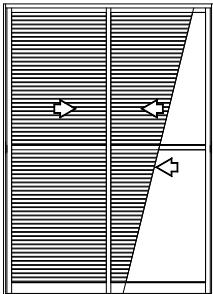

* Solução com travessa ou sem travessa

PC600VZ
PORTA DE CORRER 6 FOLHAS COM VENEZIANA

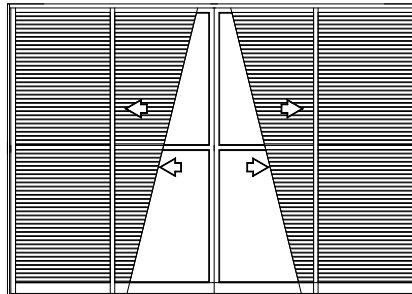

* Solução com travessa ou sem travessa

IPC200
PORTA DE CORRER 2 FOLHAS COM PERSIANA INTEGRADA

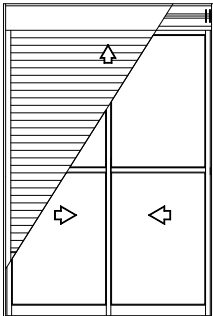

* Solução com travessa ou sem travessa

IPC400
PORTA DE CORRER 4 FOLHAS COM PERSIANA INTEGRADA

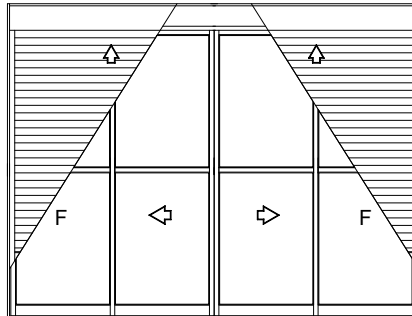

* Solução com travessa ou sem travessa

2

Cálculo Estructural

DIMENSIONAMIENTO / FÓRMULAS

CÁLCULO ESTRUTURAL
DIMENSIONAMENTO / FÓRMULAS**NORMA ABNT NBR 10821-2:2023**

A Norma ABNT NBR 10821-2:2023 especifica os requisitos exigíveis de desempenho de esquadrias externas para edificações.

Os requisitos de classificação das esquadrias instaladas na posição vertical em edifícios de caráter residencial ou comercial, são no mínimo os estabelecidos para as cinco classes em relação ao número de pavimentos e à altura da edificação. As pressões de ensaio a serem adotadas estão indicadas na Tabela 1 e Figura 3, sendo sempre considerado o último pavimento da edificação onde as esquadrias estiverem instaladas, mantendo-se este valor para todos os pavimentos.

- até dois pavimentos: esquadrias instaladas em edifícios até dois pavimentos e altura máxima de 6 metros;
- até cinco pavimentos: esquadrias instaladas em edifícios até cinco pavimentos e altura máxima de 15 metros;
- até dez pavimentos: esquadrias instaladas em edifícios até dez pavimentos e altura máxima de 30 metros;
- até vinte pavimentos: esquadrias instaladas em edifícios até vinte pavimentos e altura máxima de 60 metros;
- até trinta pavimentos: esquadrias instaladas em edifícios até trinta pavimentos e altura máxima de 90 metros.

Para esquadrias instaladas nas situações a seguir descritas, deve ser consultada a ABNT NBR 6123 para a determinação da pressão de projeto (P_p) e pressão de ensaio (P_e), prevalecendo como mínimo os valores da Tabela 1.

- edifícios em que as esquadrias não sejam instaladas na posição vertical;
- edifícios de forma não retangular;
- edifícios com especificações, localização, necessidades e exigências especiais de utilização.

NOTA 1 Para o cálculo da pressão de segurança (P_s) multiplica-se uma vez e meia (1,5) a pressão de ensaio (P_e).

MAPA DAS ISOPLETAS DE VELOCIDADE BÁSICA DOS VENTOS EM M/S (NBR-6123)

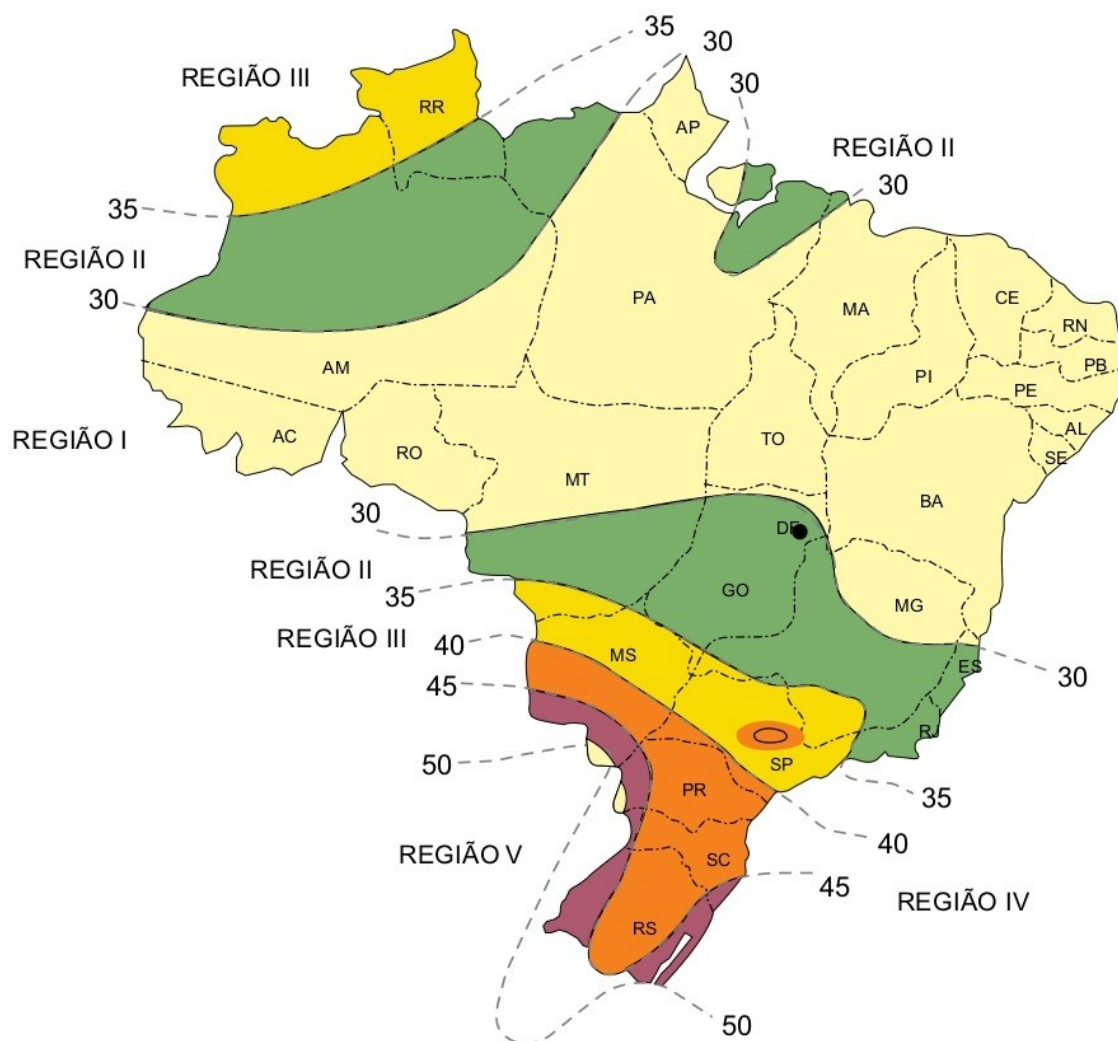

- Região I (30 m/s)
- Região II (35 m/s)
- Região III (40 m/s)
- Região IV (45 m/s)
- Região V (50 m/s)

Para determinar a pressão de ensaio a ser aplicada nas esquadrias, é necessário identificar a Região do País da localização da obra segundo o Gráfico das Isopletas.

Conforme a Região do País, encontre a Pressão de ensaio (Pe) para edificação, a quantidade de pavimentos ou altura máxima do empreendimento, segundo a norma técnica ABNT NBR 10821-2:2023.

Valores de pressão de vento conforme a região do país e o número de pavimentos da edificação					
Quantidade de pavimentos	Altura máxima	Região do País	Pressão de ensaio Pe, em (Pa) Positiva e negativa $Pe = Pp \times 1,2$	Pressão de segurança Ps, em (Pa) Positiva e negativa $Ps = Pp \times 1,5$	Pressão de água Pa, em (Pa) $Pa = Pp \times 0,20$
02	6 m	I	350	520	60
		II	470	700	80
		III	610	920	100
		IV	770	1160	130
		V	950	1430	160
05	15 m	I	420	640	70
		II	580	860	100
		III	750	1130	130
		IV	950	1430	160
		V	1180	1760	200
10	30 m	I	500	750	80
		II	680	1030	110
		III	890	1340	150
		IV	1130	1700	190
		V	1400	2090	230
20	60 m	I	600	900	100
		II	815	1220	140
		III	1060	1600	180
		IV	1350	2020	220
		V	1660	2500	280
30	90 m	I	660	980	110
		II	890	1340	150
		III	1170	1750	200
		IV	1480	2210	250
		V	1820	2730	300

Nos gráficos de desempenho, o cruzamento das informações de altura e largura da tipologia resulta o valor da pressão de ensaio calculado para o conjunto de perfis ilustrado. Caso o valor seja igual ou superior ao encontrado na coluna de pressão de ensaio acima, a esquadria atende ao projeto especificado.

LIMITES DE ESFORÇO POR USO

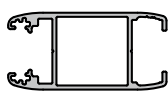
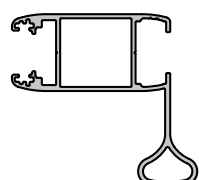
FOLHA DE CORRER (JANELA) LIGA 6060-T5		
	RE-22301	RE-22304
Perfil		
Altura máx. (H)	890 mm	1890 mm

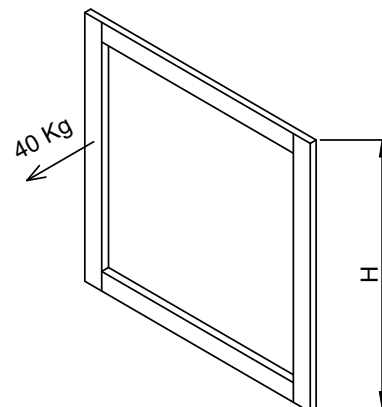

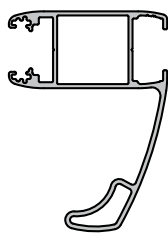
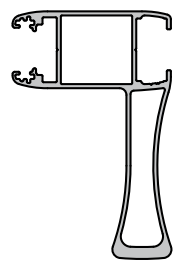
FOLHA DE CORRER (PORTA) LIGA 6060-T5		
	RE-22302	RE-22303
Perfil		
Altura máx. (H)	2655 mm	3390 mm

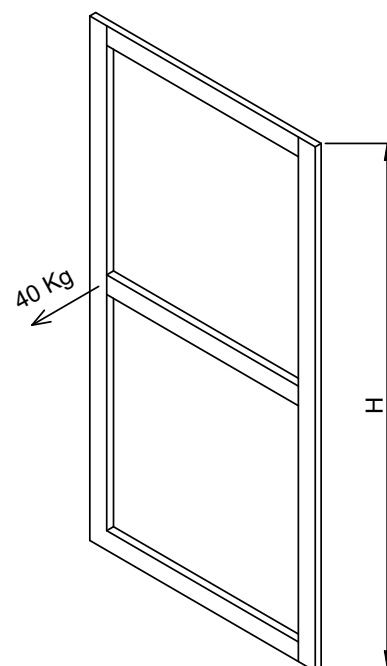

OBSERVAÇÃO: Altura máxima para ensaio de deflexão. Determinar a altura máxima da esquadria levando em consideração a pressão de vento nos perfis de mão de amigo juntamente com os dados acima.

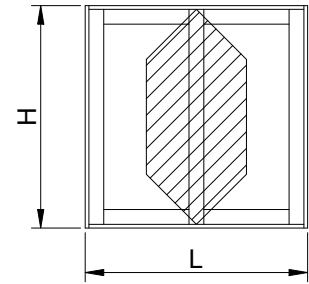

RE-22401		
Jx	13.643	mm4
Wx	923	mm3

RE-22401		
Jx	13.643	mm4
Wx	923	mm3

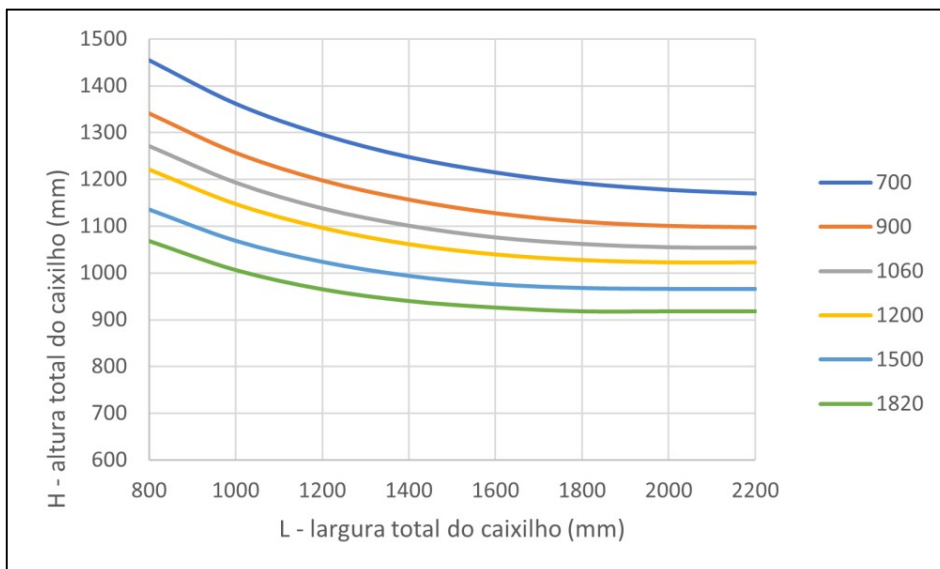
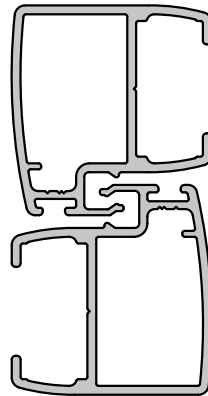

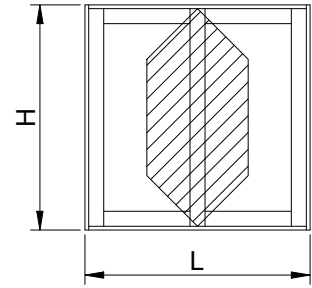

RE-22401		
Jx	13.643	mm4
Wx	923	mm3

RE-22404		
Jx	73.307	mm4
Wx	2.489	mm3

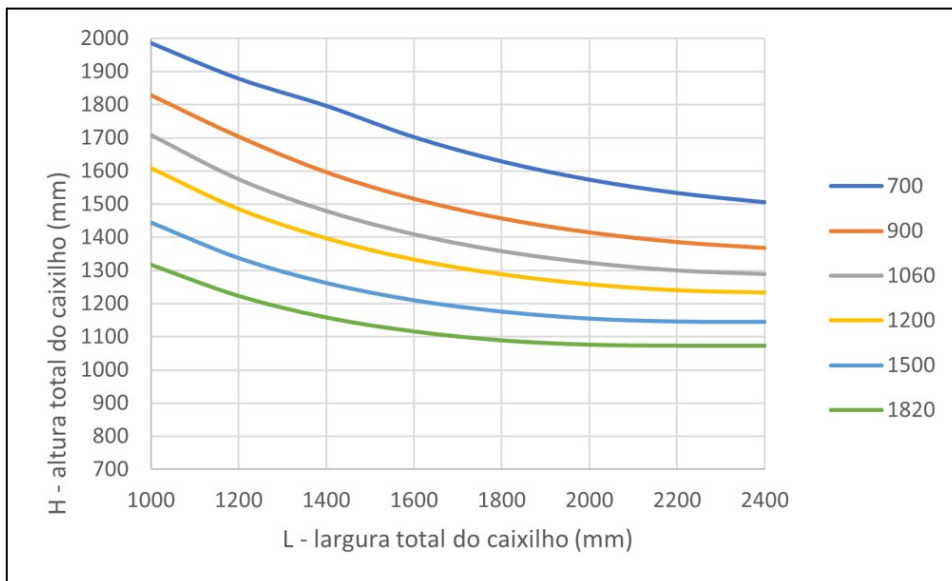
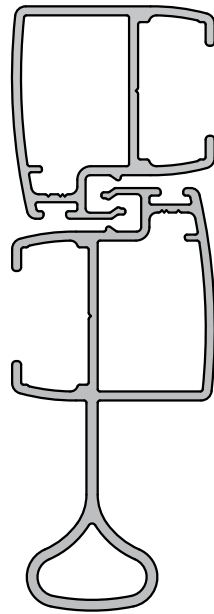

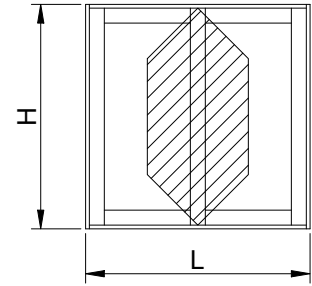

RE-22404		
Jx	73.307	mm4
Wx	2.489	mm3

RE-22404		
Jx	73.307	mm4
Wx	2.489	mm3

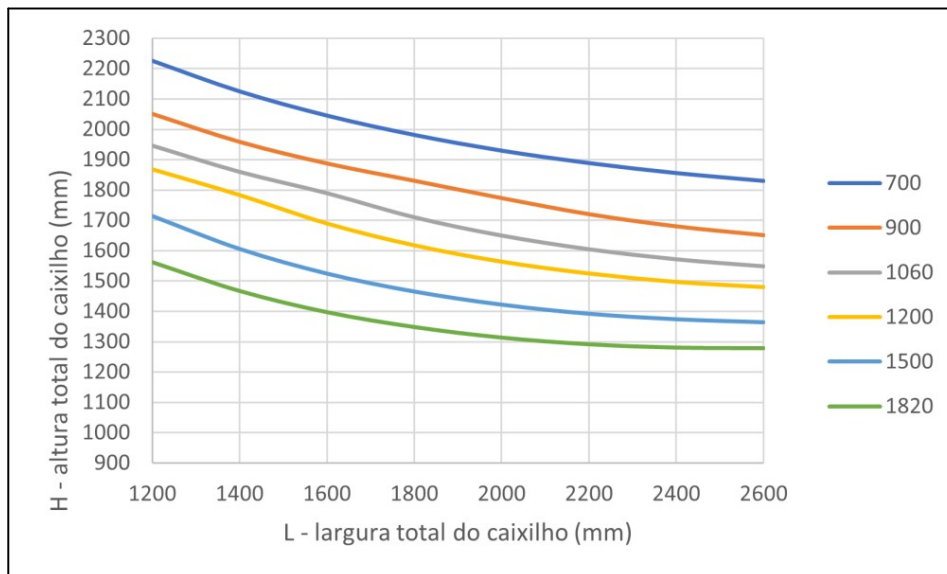
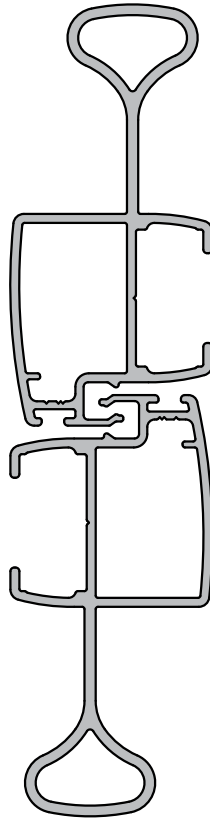

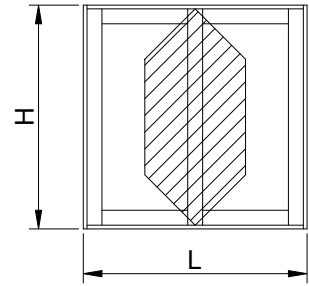

RE-22401		
Jx	13.643	mm ⁴
Wx	923	mm ³

RE-22402		
Jx	141.109	mm ⁴
Wx	3.861	mm ³

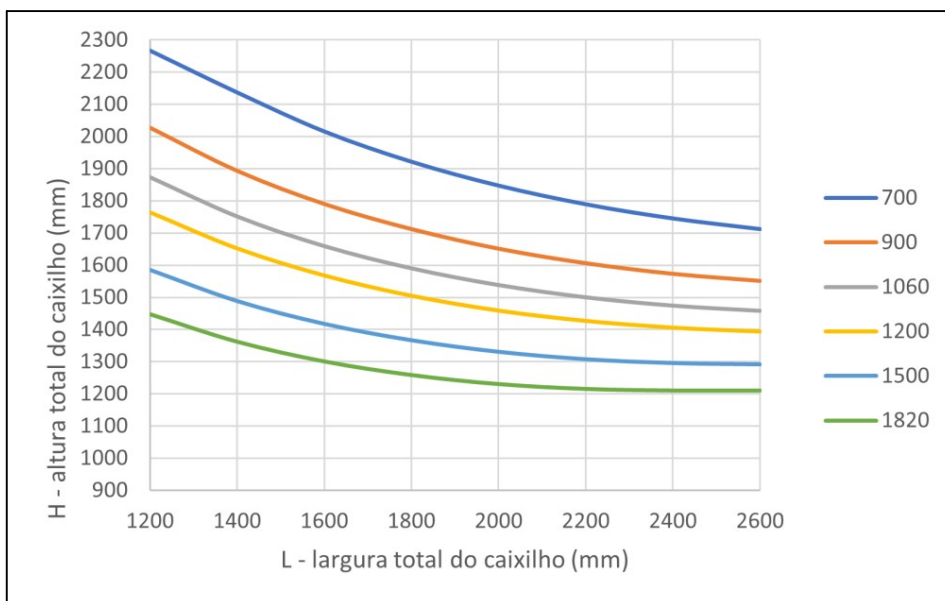
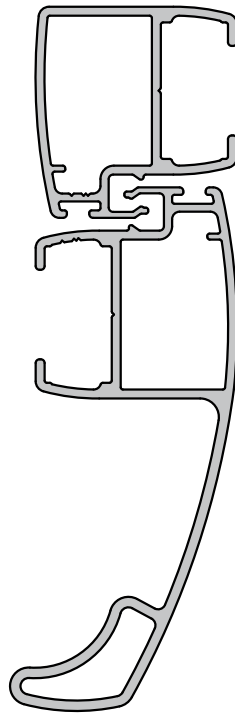

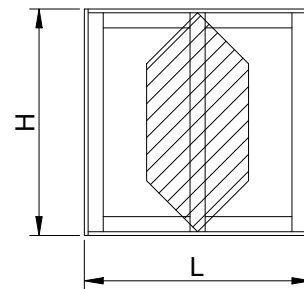

RE-22404		
Jx	73.307	mm4
Wx	2.489	mm3

RE-22402		
Jx	141.109	mm4
Wx	3.861	mm3

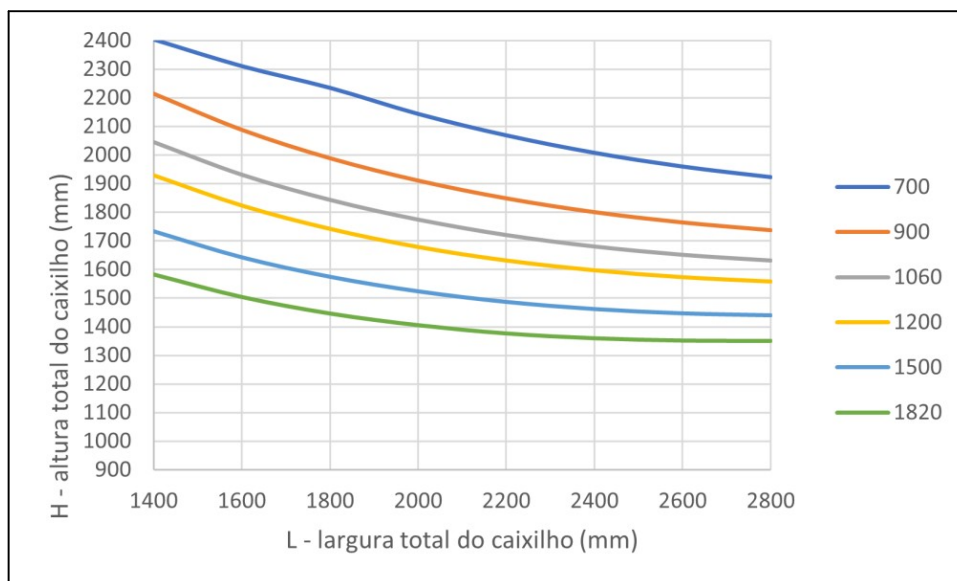
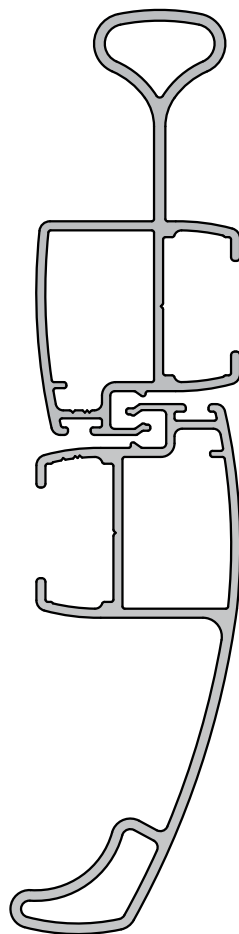

RE-22402		
Jx	141.109	mm ⁴
Wx	3.861	mm ³

RE-22402		
Jx	141.109	mm ⁴
Wx	3.861	mm ³

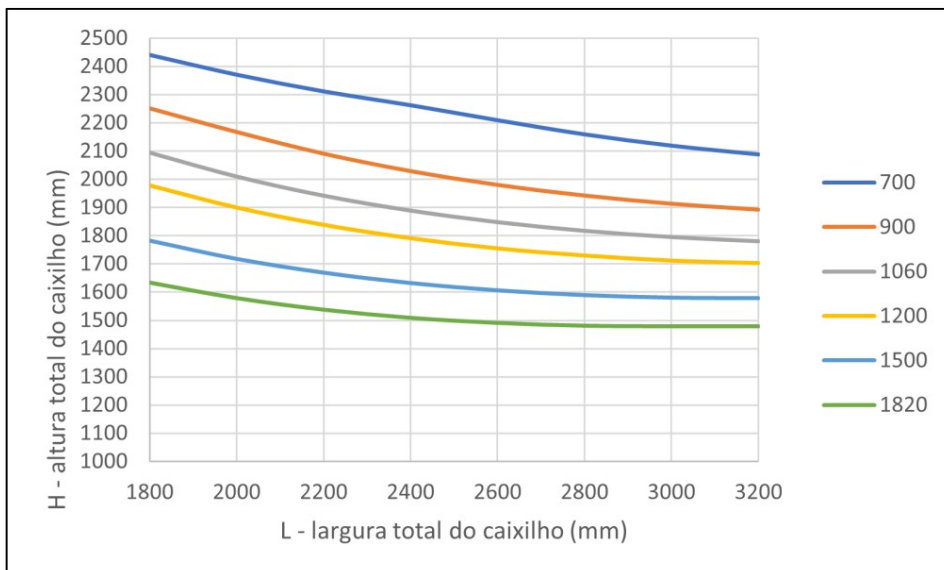
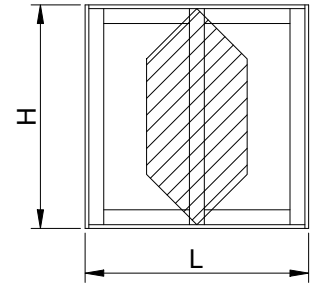
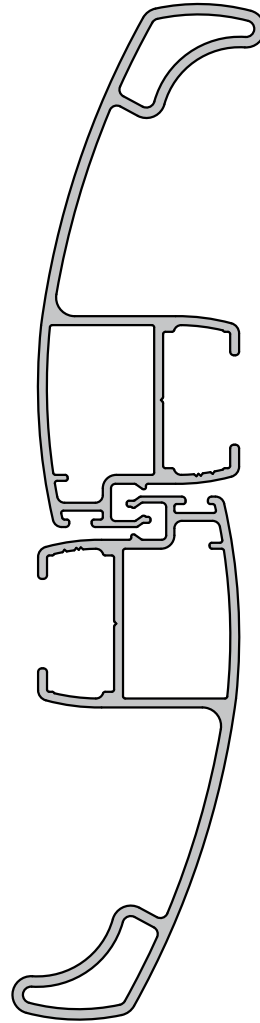

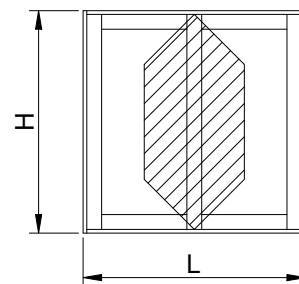

RE-22401		
Jx	13.643	mm4
Wx	923	mm3

RE-22403		
Jx	223.669	mm4
Wx	5.590	mm3

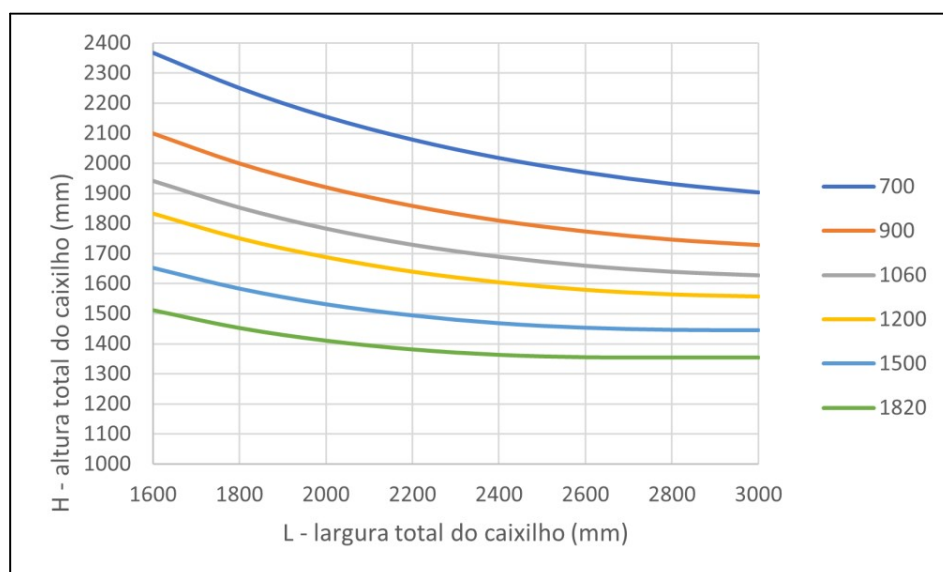
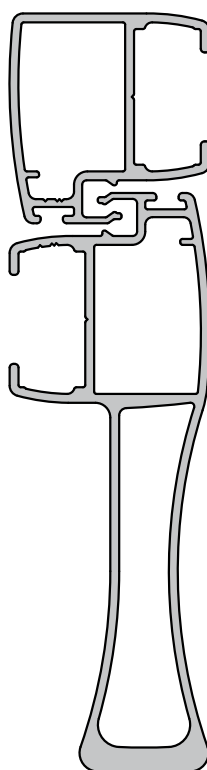

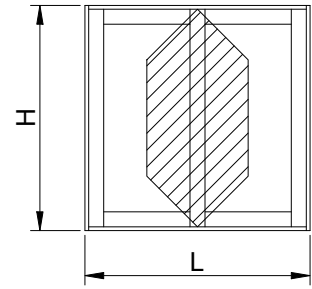

RE-22404		
Jx	73.307	mm ⁴
Wx	2.489	mm ³

RE-22403		
Jx	223.669	mm ⁴
Wx	5.590	mm ³

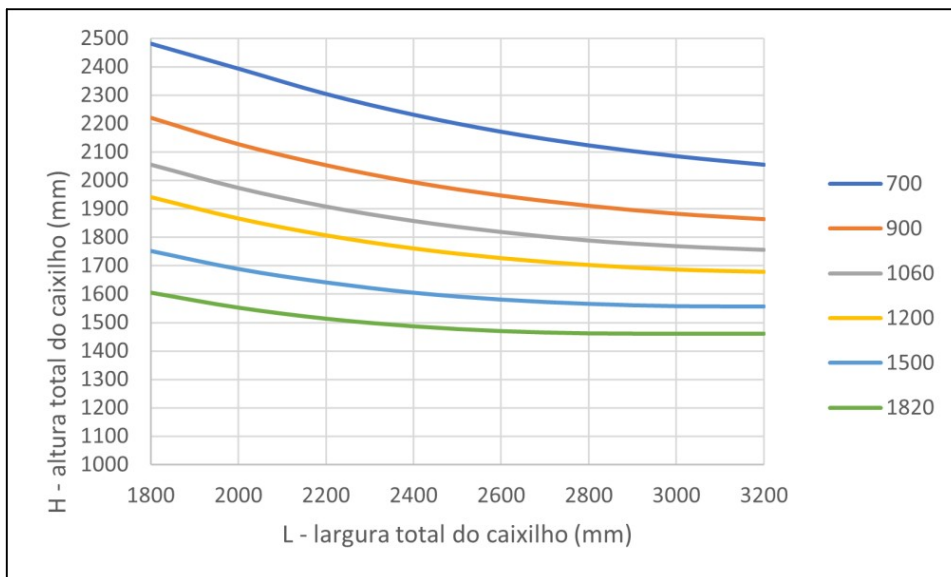
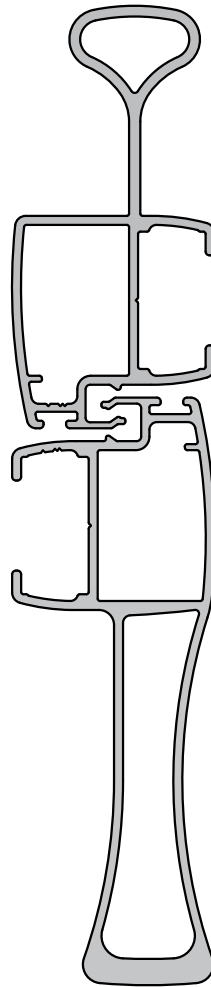

RE-22402		
Jx	141.109	mm ⁴
Wx	3.861	mm ³

RE-22403		
Jx	223.669	mm ⁴
Wx	5.590	mm ³

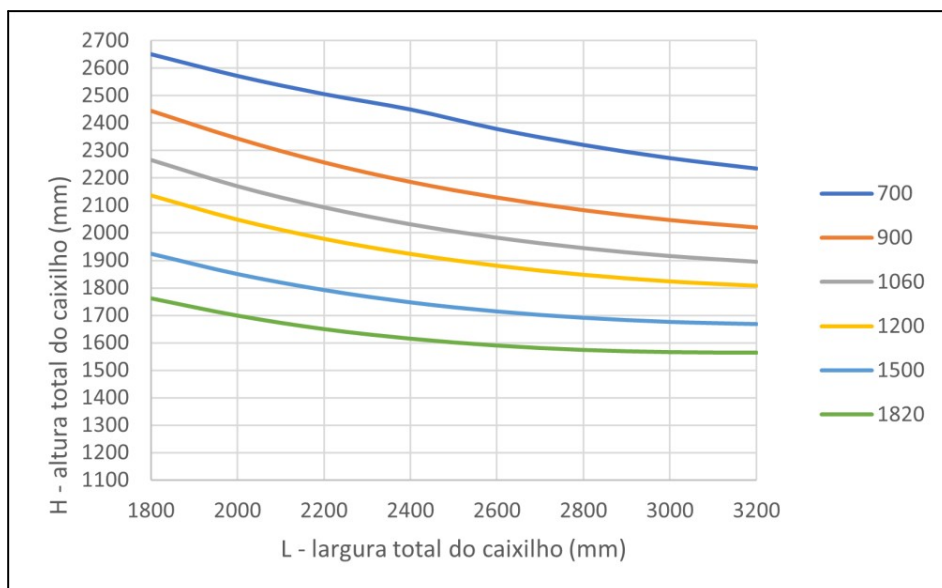
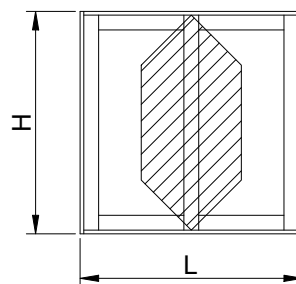
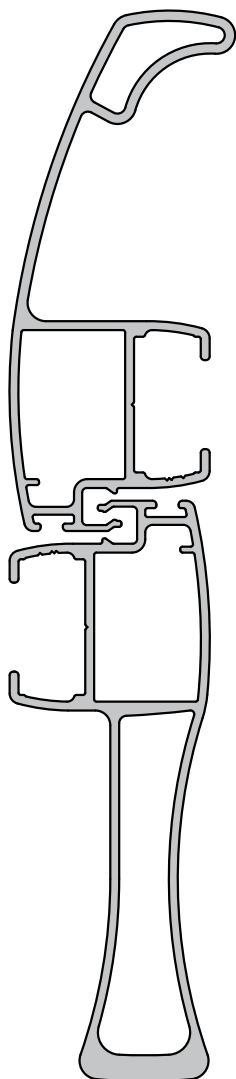

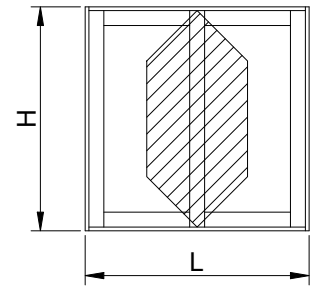
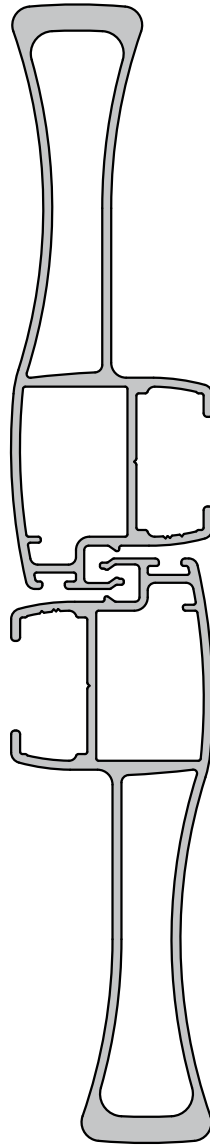

RE-22403		
Jx	223.669	mm ⁴
Wx	5.590	mm ³

RE-22403		
Jx	223.669	mm ⁴
Wx	5.590	mm ³

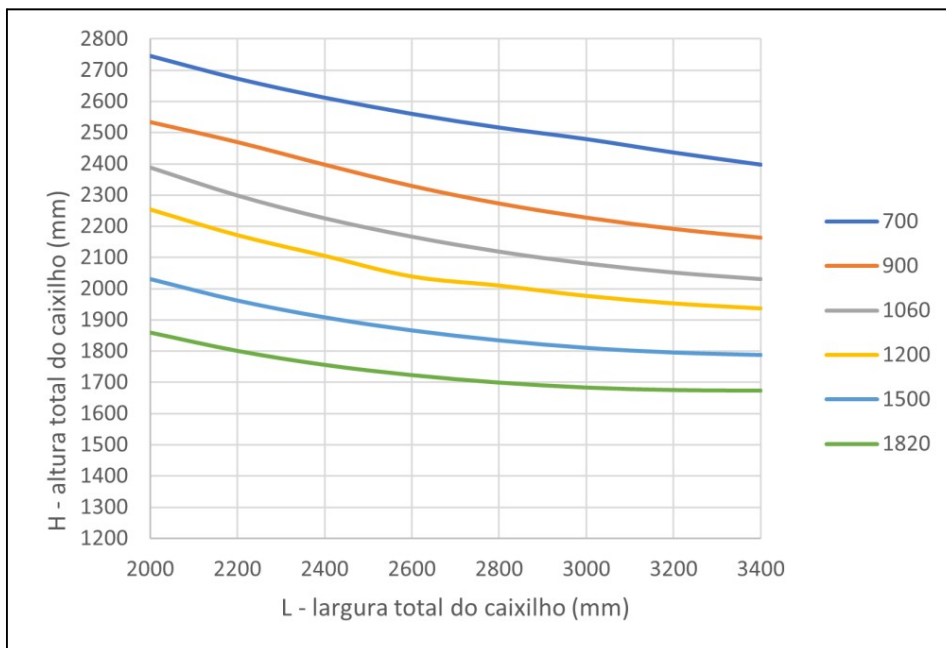

RE-22401		
Jx	13.643	mm4
Wx	923	mm3

RE-22405		
Jx	19.502	mm4
Wx	1.141	mm3

RE-22401		
Jx	13.643	mm4
Wx	923	mm3

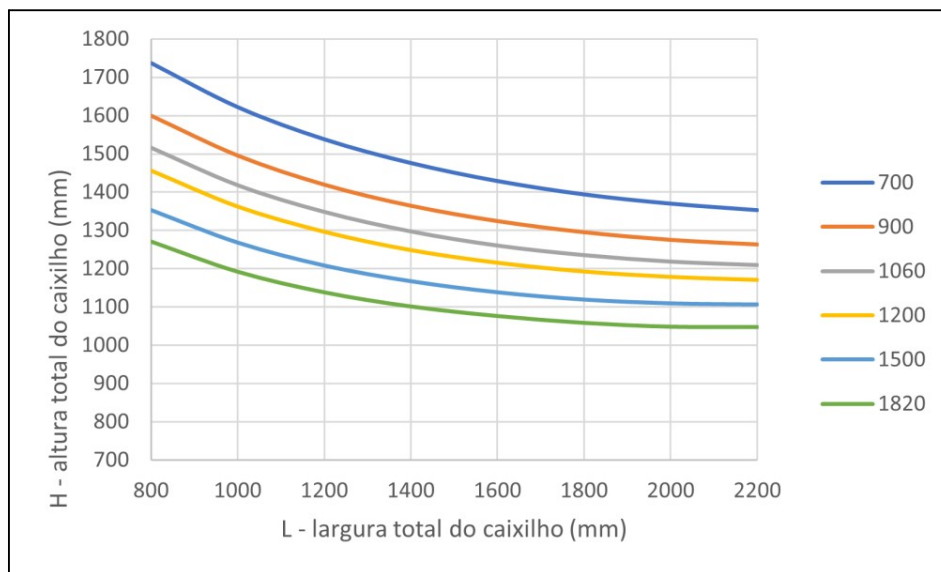
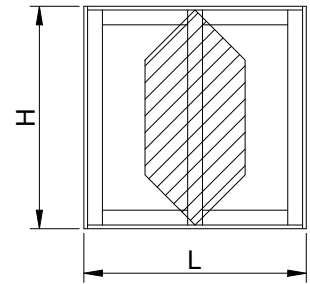
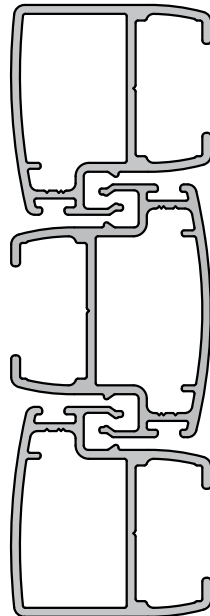

RE-22404		
Jx	73.307	mm4
Wx	2.489	mm3

RE-22405		
Jx	19.502	mm4
Wx	1.141	mm3

RE-22401		
Jx	13.643	mm4
Wx	923	mm3

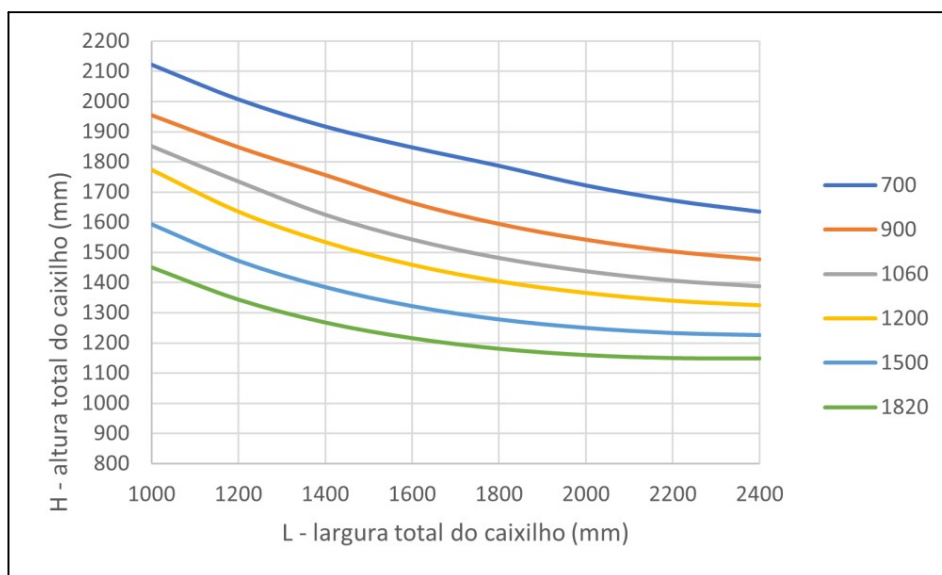
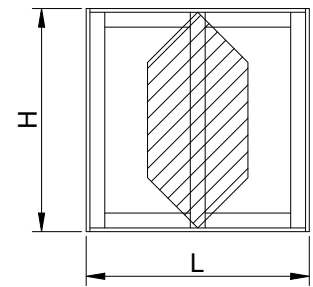
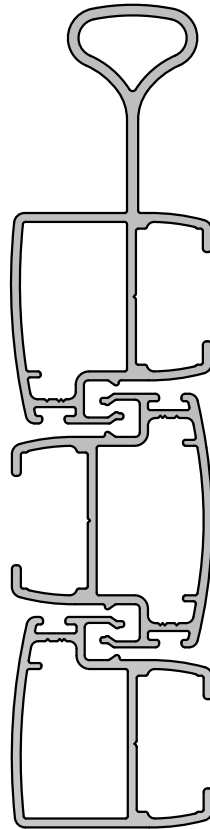

RE-22404		
Jx	73.307	mm ⁴
Wx	2.489	mm ³

RE-22405		
Jx	19.502	mm ⁴
Wx	1.141	mm ³

RE-22404		
Jx	73.307	mm ⁴
Wx	2.489	mm ³

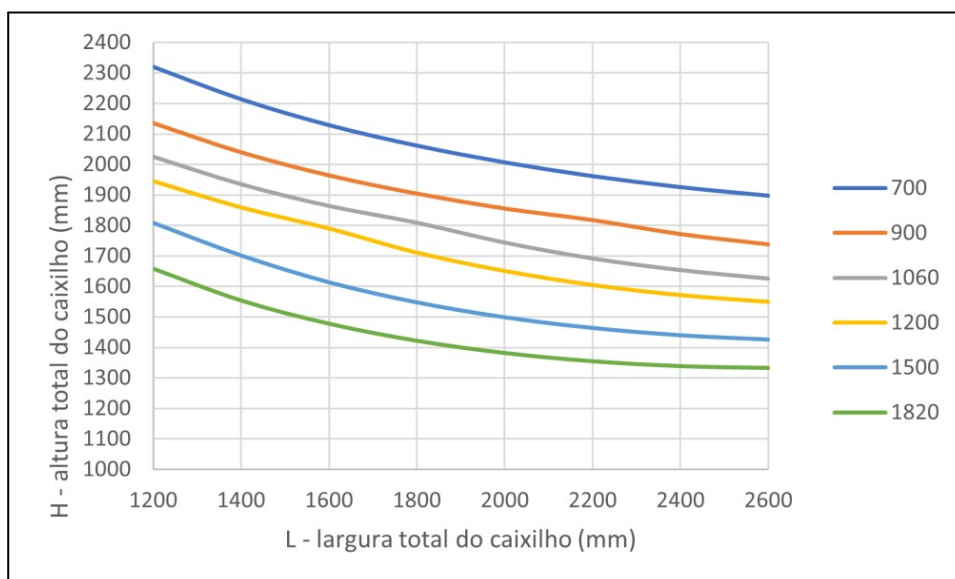
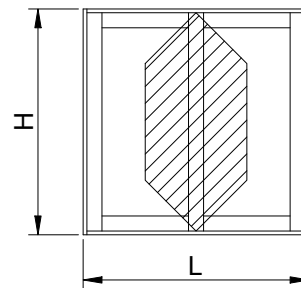
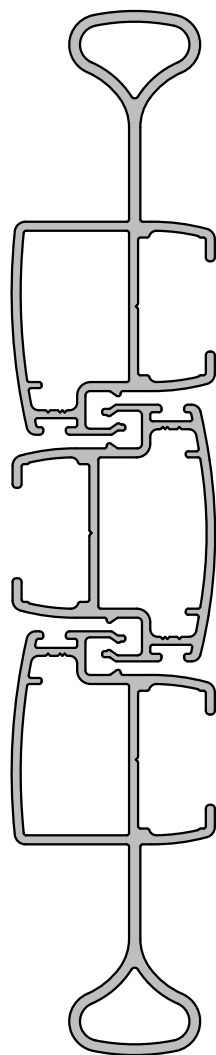

RE-22404		
Jx	73.307	mm4
Wx	2.489	mm3

RE-22405		
Jx	19.502	mm4
Wx	1.141	mm3

RE-22402		
Jx	141.109	mm4
Wx	3.861	mm3

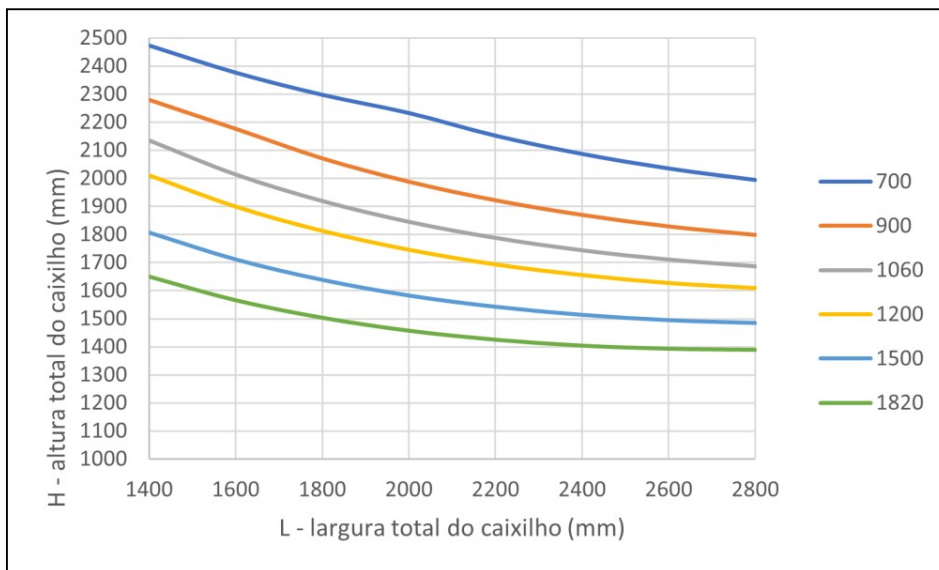
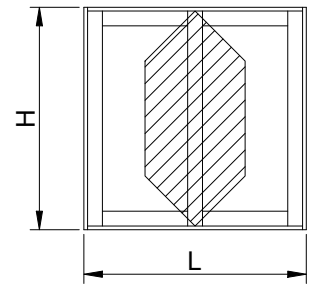
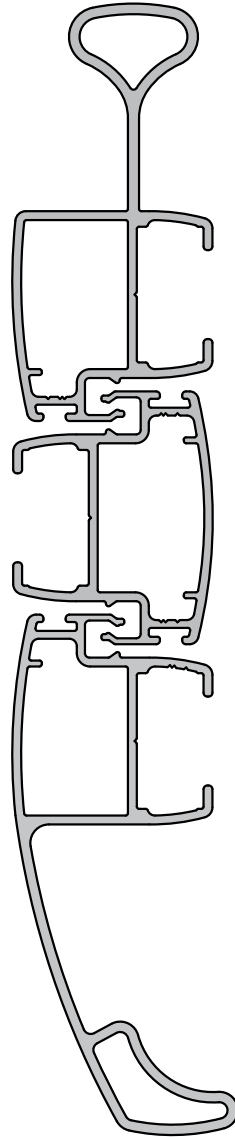

RE-22404		
Jx	73.307	mm ⁴
Wx	2.489	mm ³

RE-22405		
Jx	19.502	mm ⁴
Wx	1.141	mm ³

RE-22403		
Jx	223.669	mm ⁴
Wx	5.590	mm ³

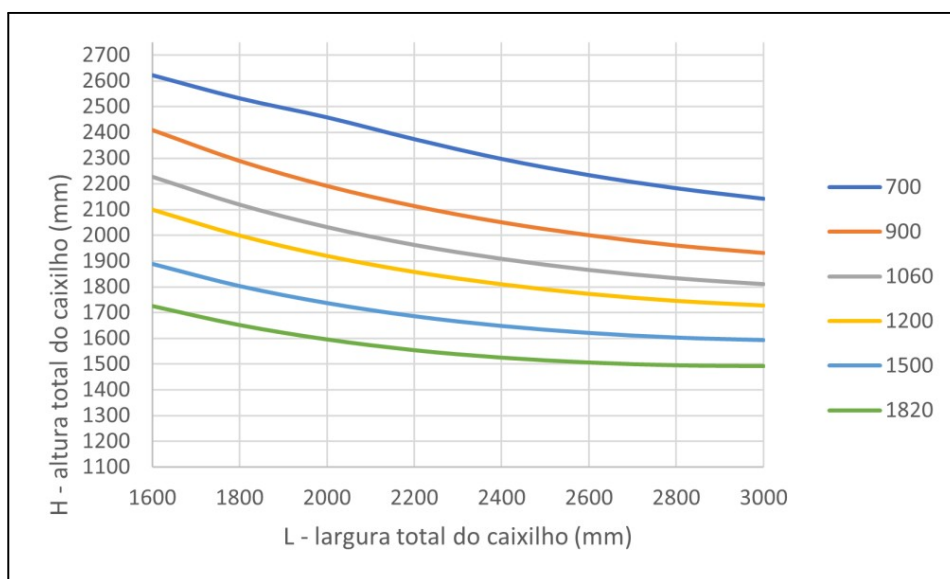
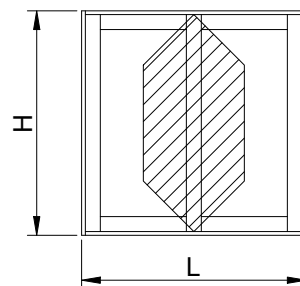
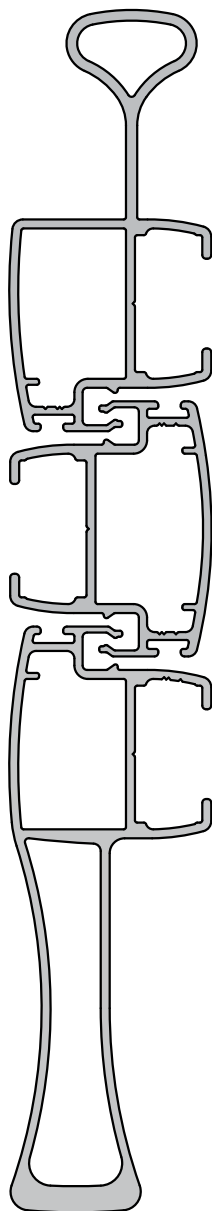

RE-22402		
Jx	141.109	mm ⁴
Wx	3.861	mm ³

RE-22405		
Jx	19.502	mm ⁴
Wx	1.141	mm ³

RE-22401		
Jx	13.643	mm ⁴
Wx	923	mm ³

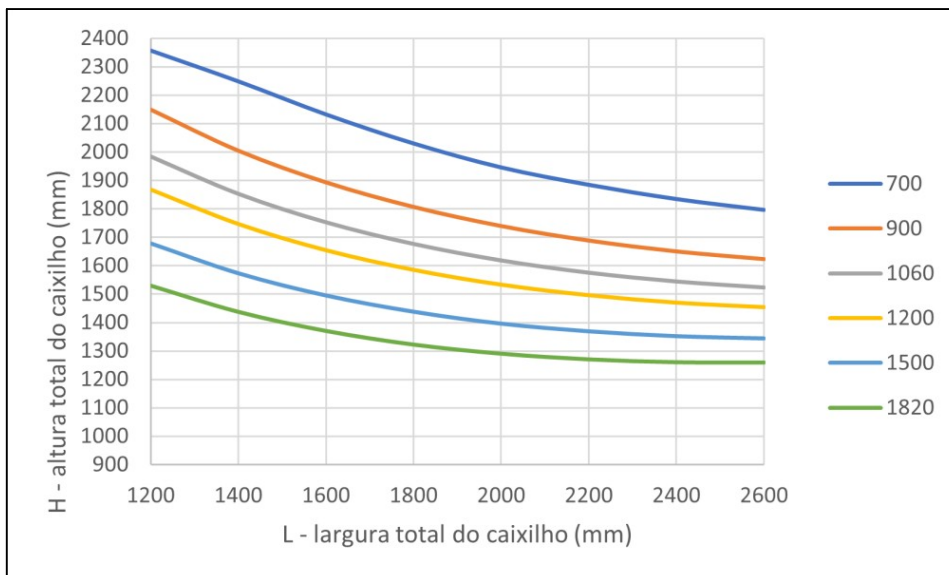
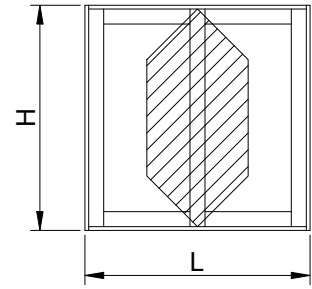
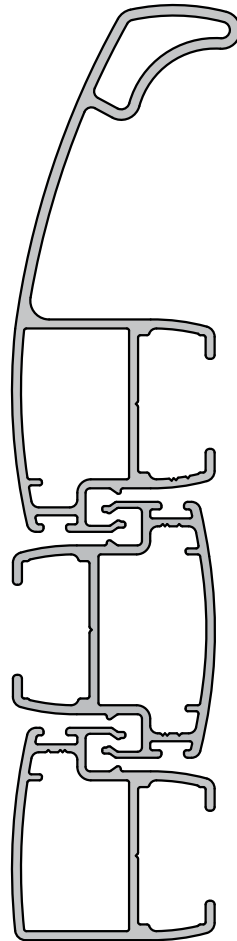

RE-22402		
Jx	141.109	mm4
Wx	3.861	mm3

RE-22405		
Jx	19.502	mm4
Wx	1.141	mm3

RE-22402		
Jx	141.109	mm4
Wx	3.861	mm3

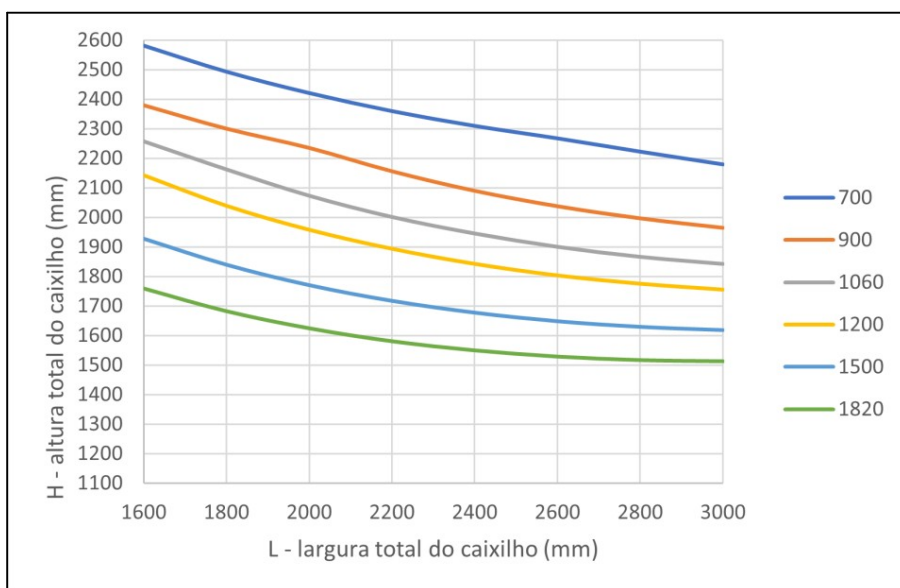
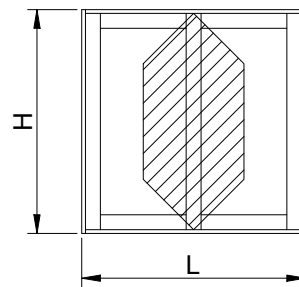
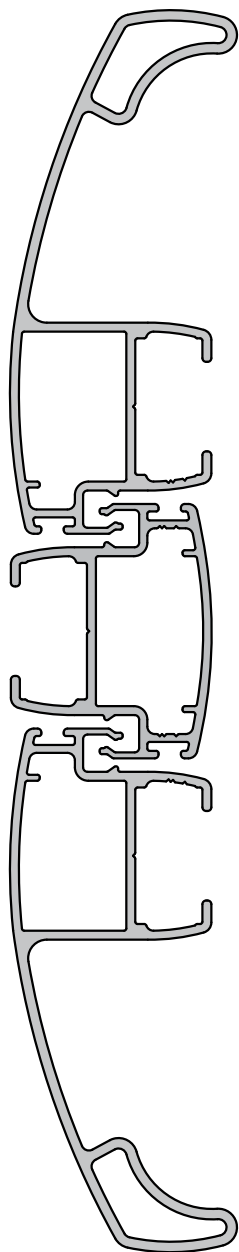

RE-22403		
Jx	223.669	mm4
Wx	5.590	mm3

RE-22405		
Jx	19.502	mm4
Wx	1.141	mm3

RE-22401		
Jx	13.643	mm4
Wx	923	mm3

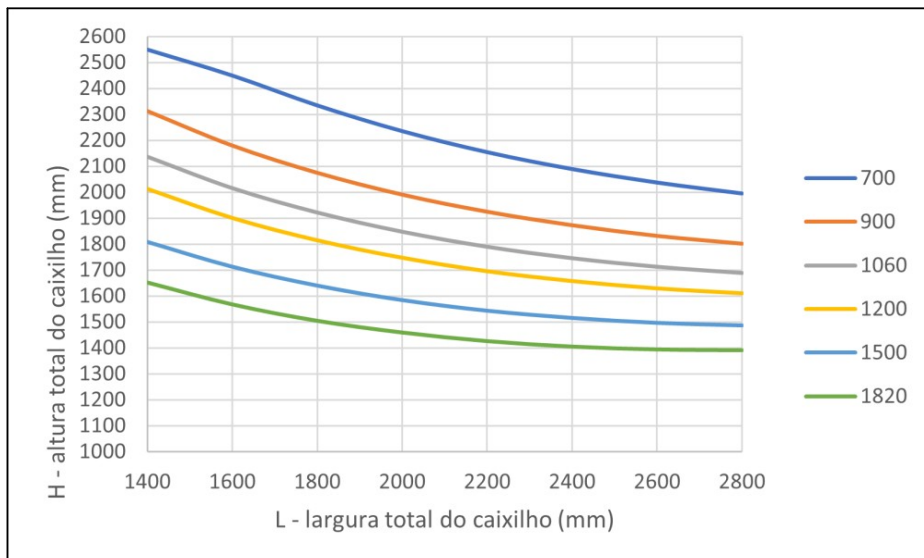
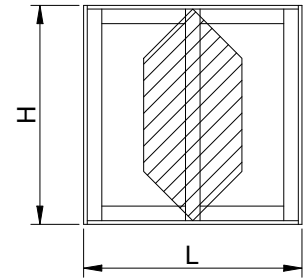
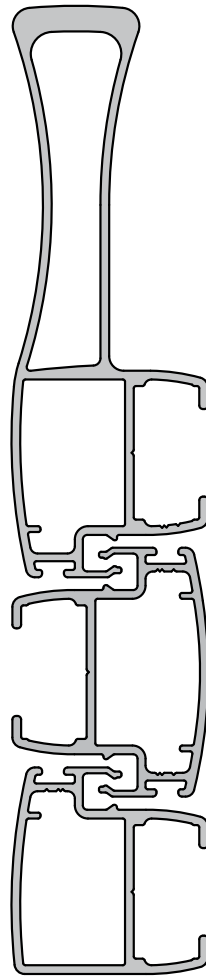

RE-22403		
Jx	223.669	mm4
Wx	5.590	mm3

RE-22405		
Jx	19.502	mm4
Wx	1.141	mm3

RE-22402		
Jx	141.109	mm4
Wx	3.861	mm3

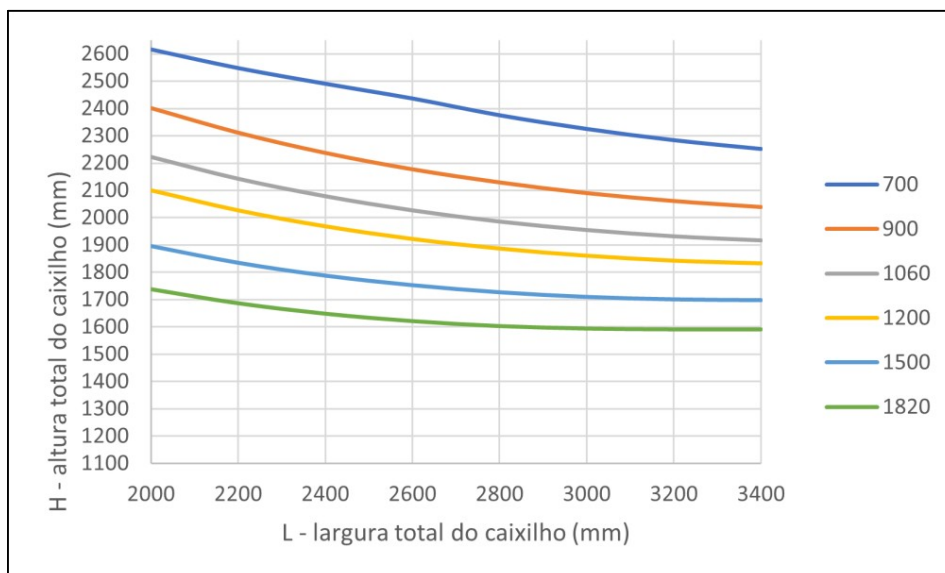
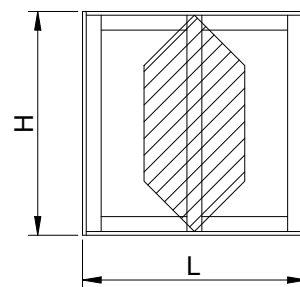
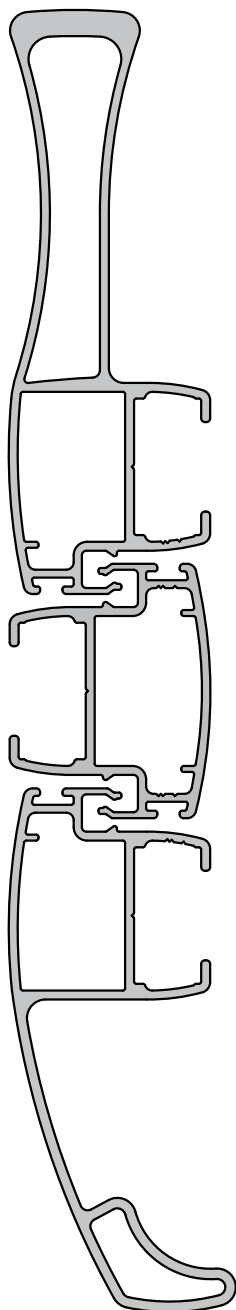

RE-22403		
Jx	223.669	mm4
Wx	5.590	mm3

RE-22405		
Jx	19.502	mm4
Wx	1.141	mm3

RE-22403		
Jx	223.669	mm4
Wx	5.590	mm3

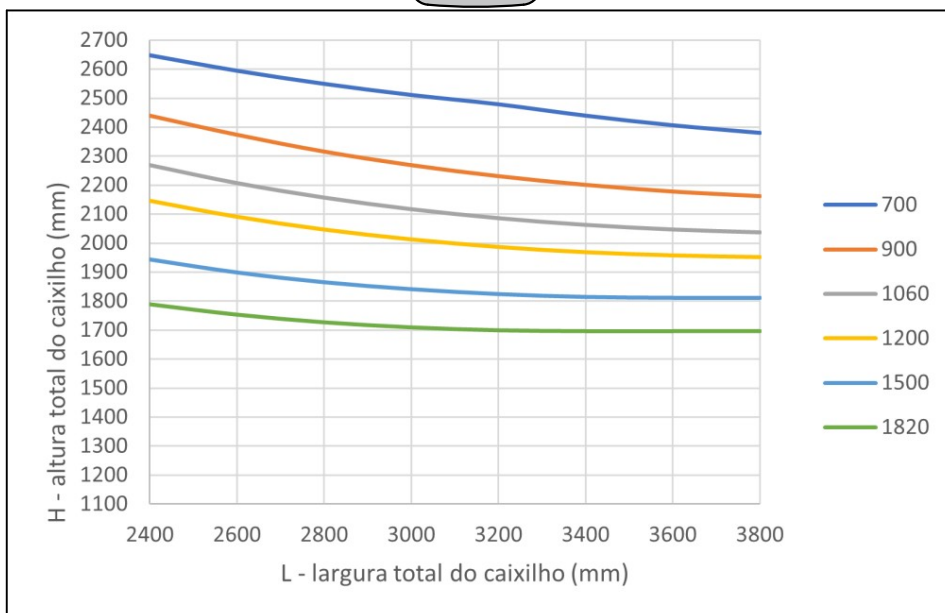
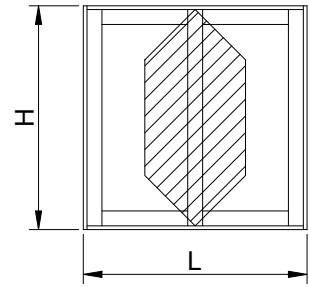
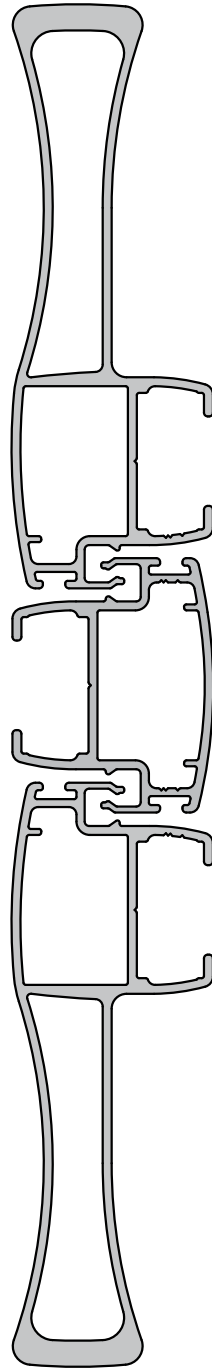

RE-22301		
Jx	16.611	mm4
Wx	1.473	mm3

RE-22301		
Jx	16.611	mm4
Wx	1.473	mm3

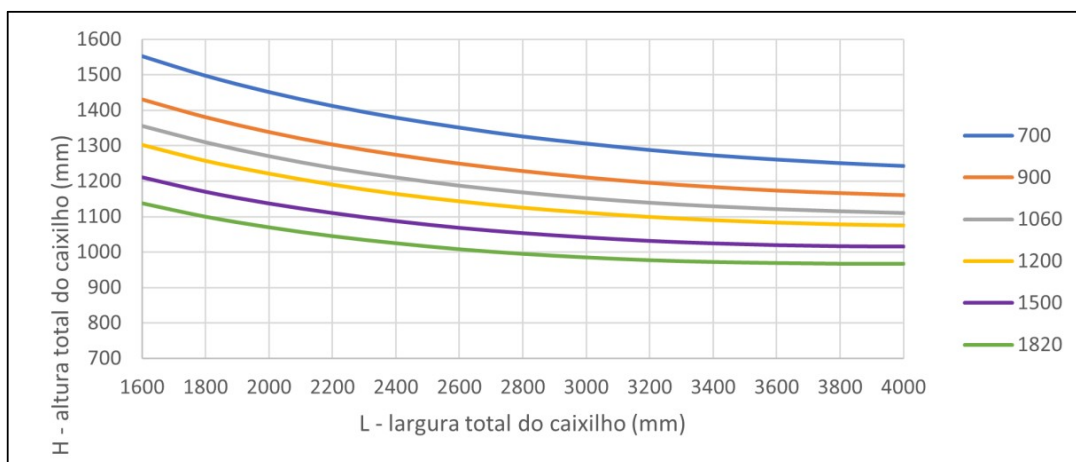
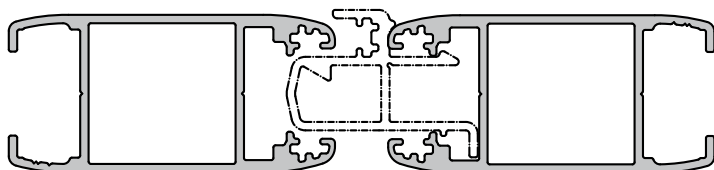
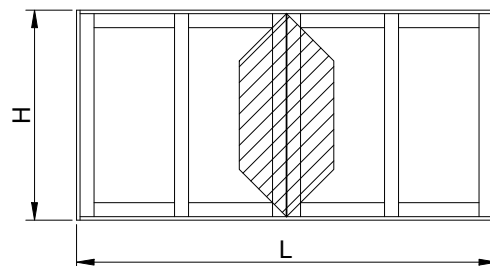

RE-22304		
Jx	74.618	mm ⁴
Wx	2.461	mm ³

RE-22304		
Jx	74.618	mm ⁴
Wx	2.461	mm ³

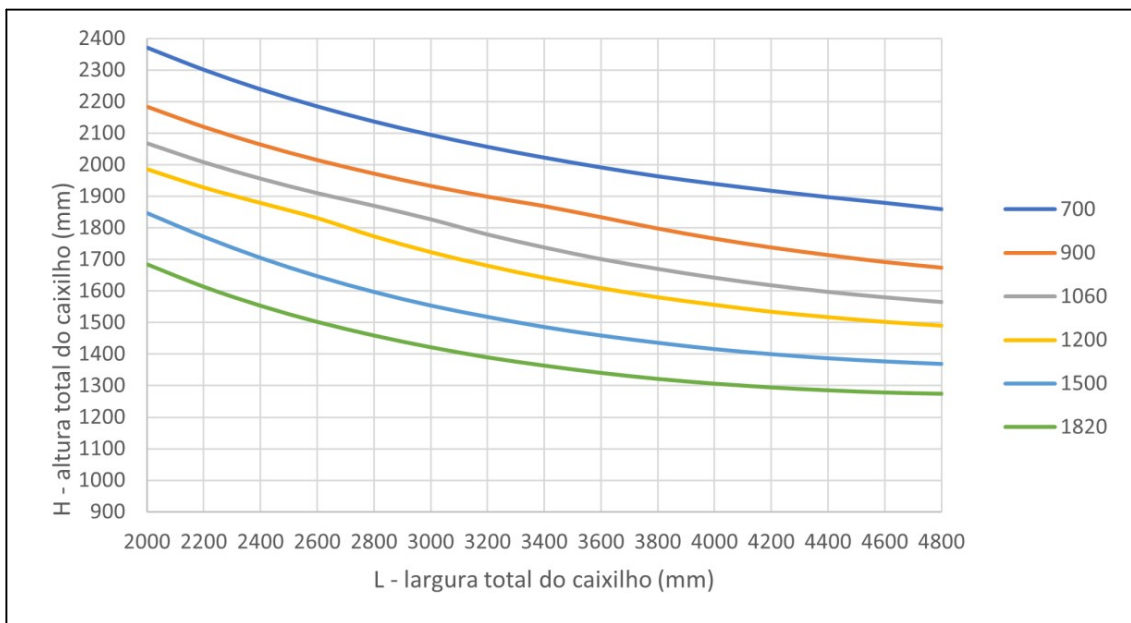
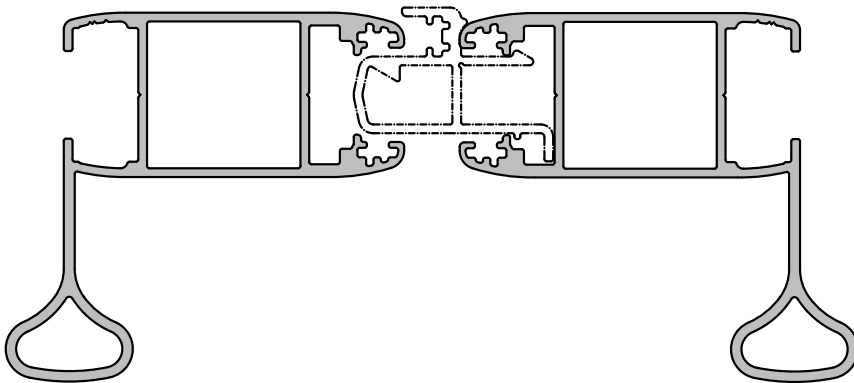
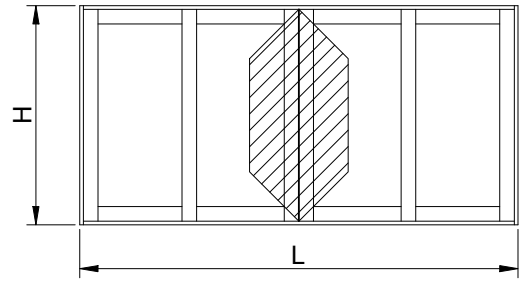

RE-22302		
Jx	147.402	mm4
Wx	3.818	mm3

RE-22302		
Jx	147.402	mm4
Wx	3.818	mm3

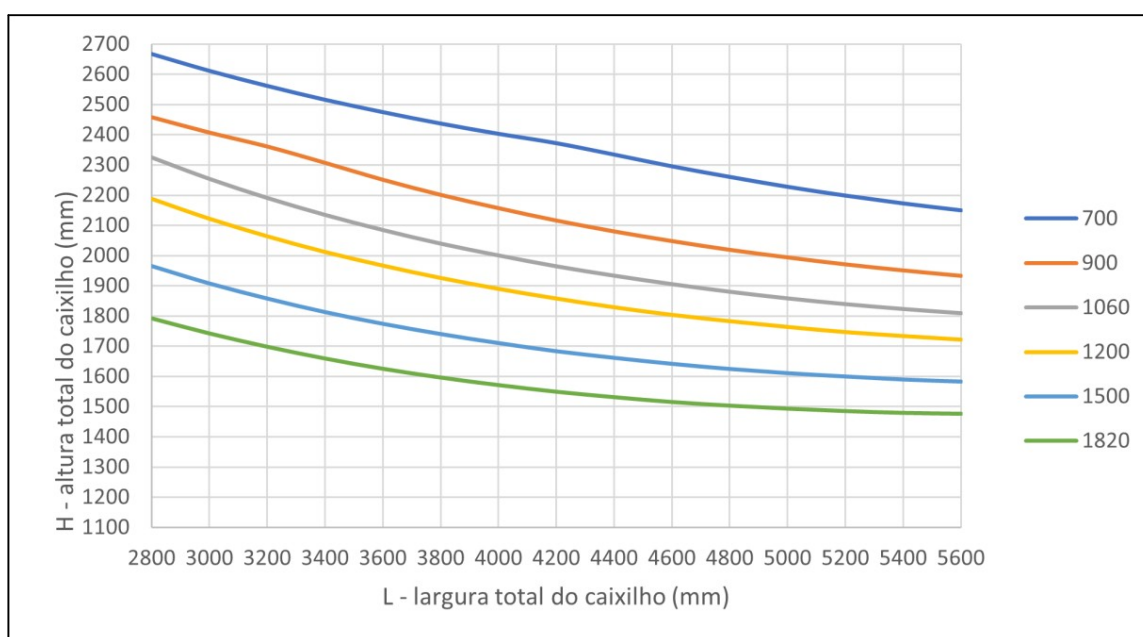
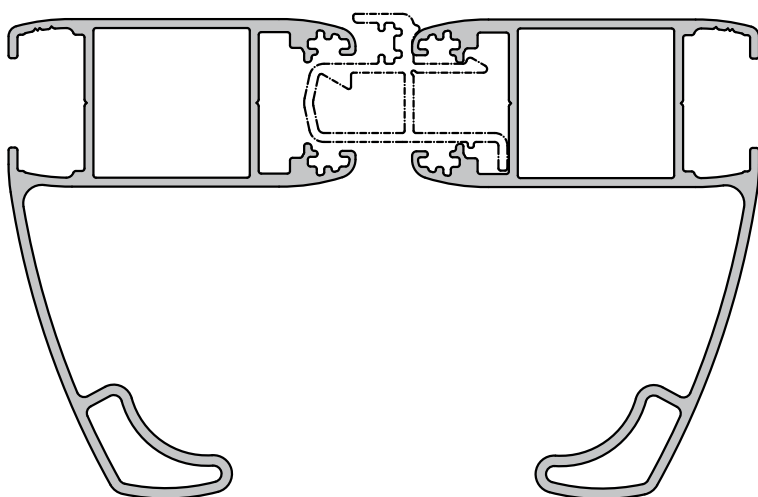
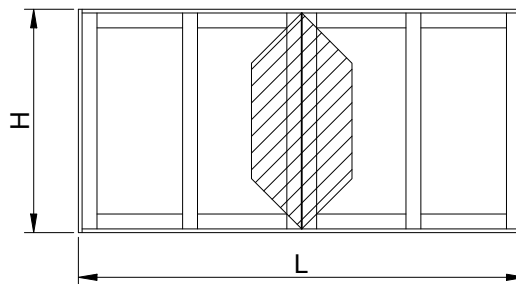

RE-22303		
Jx	239.651	mm ⁴
Wx	5.838	mm ³

RE-22303		
Jx	239.651	mm ⁴
Wx	5.838	mm ³

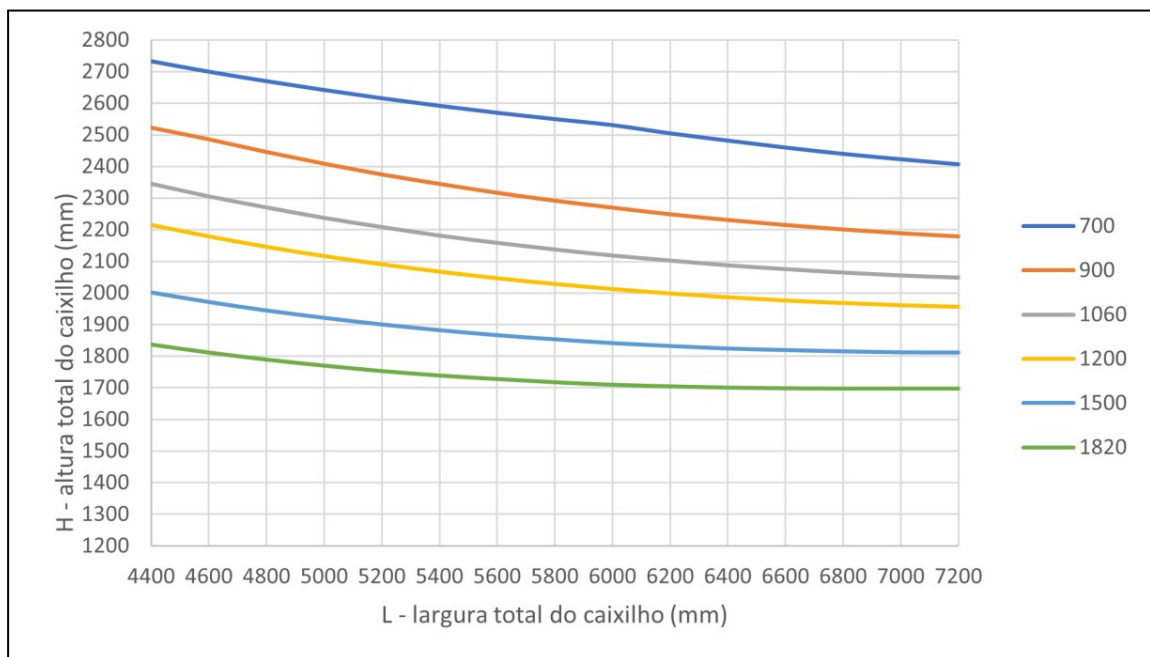
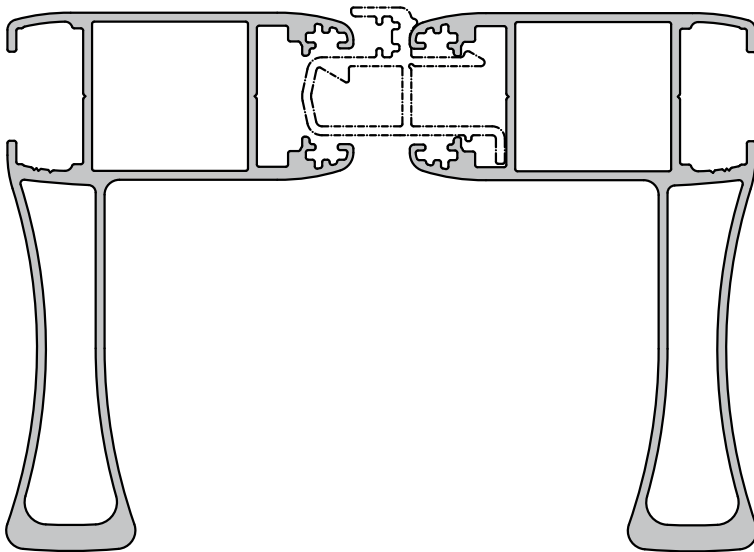
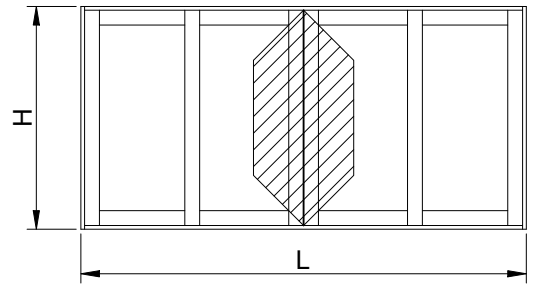

RE-22005		
Jy	130.192	mm4
Wy	3.735	mm3

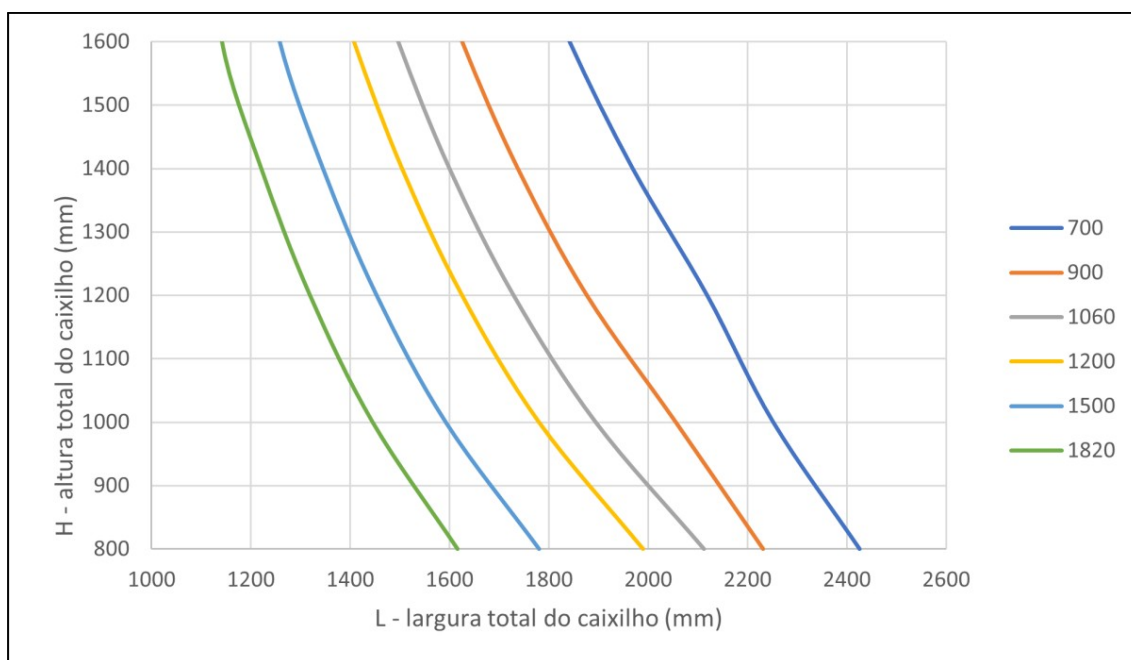
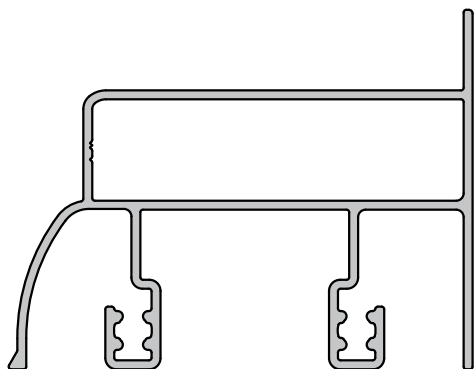
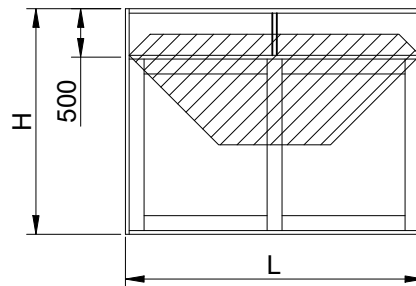

RE-22012		
Jy	105.135	mm ⁴
Wy	3.689	mm ³

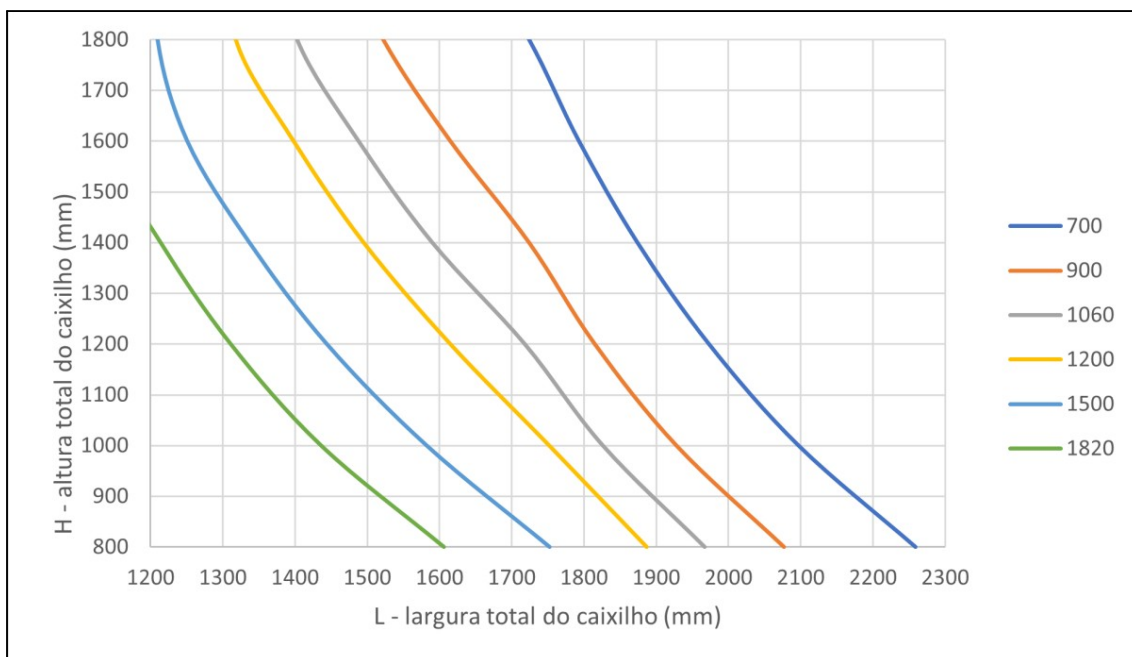
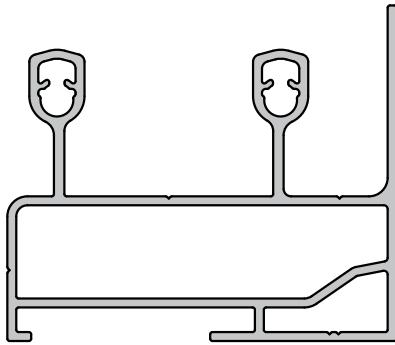
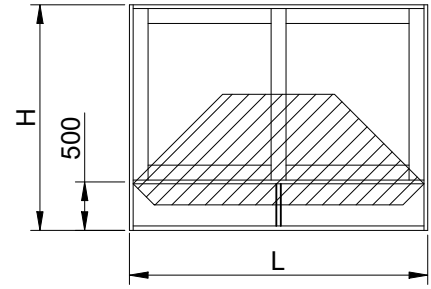

RE-22105		
Jy	403.393	mm4
Wy	8.042	mm3

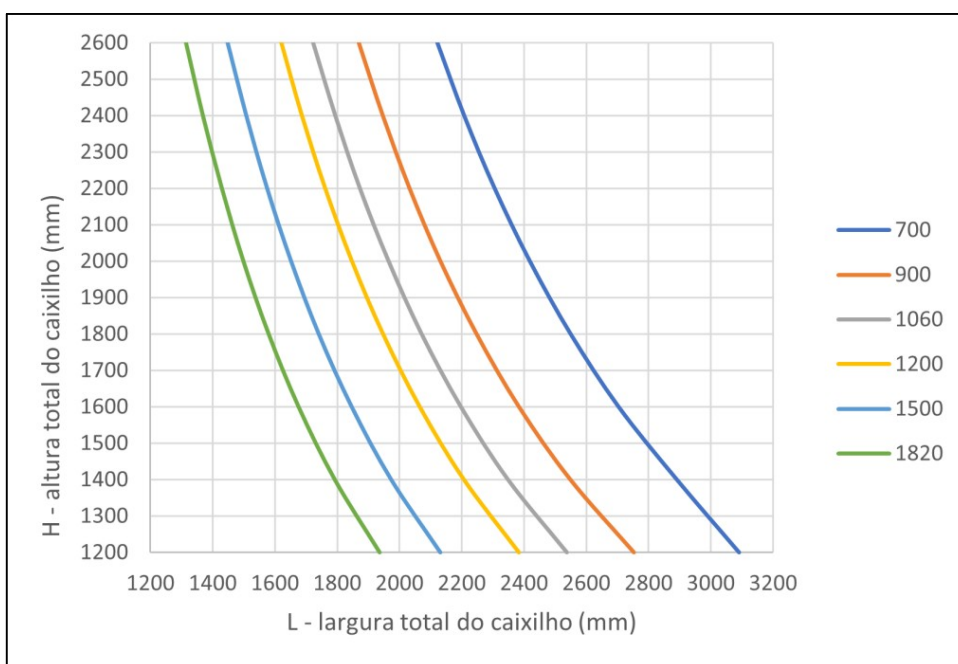
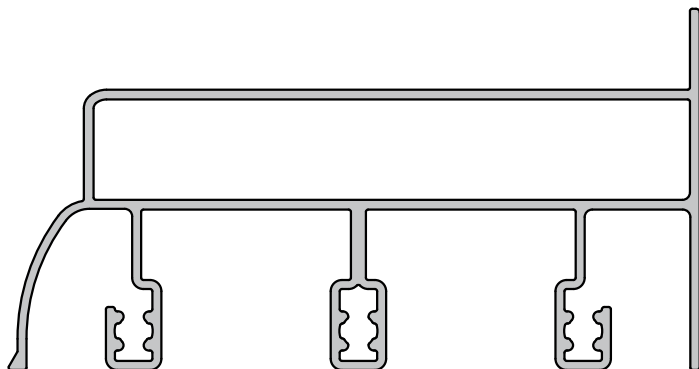
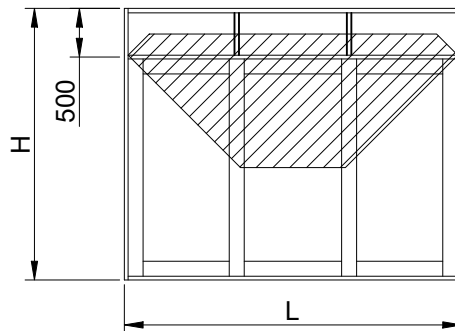

RE-22112		
Jy	362.129	mm ⁴
Wy	8.195	mm ³

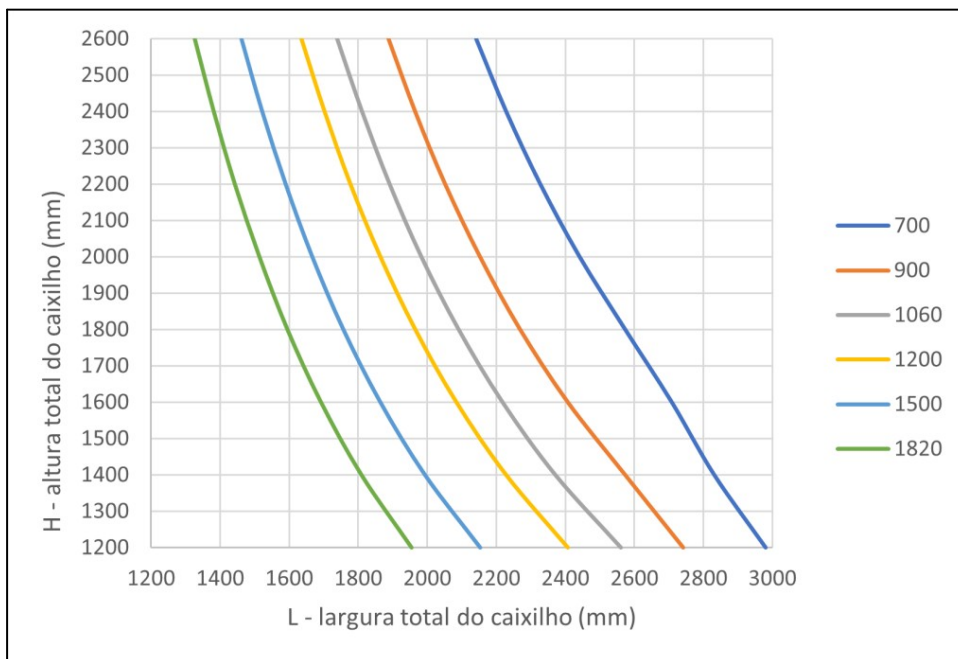
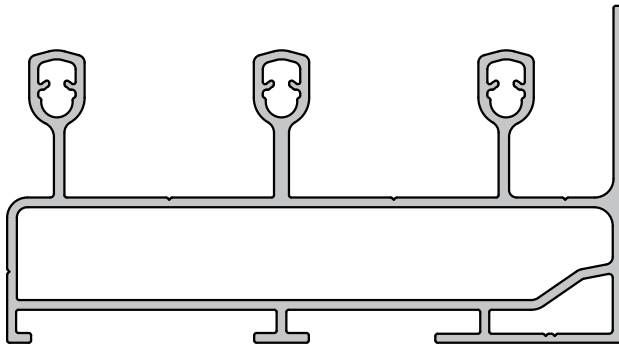
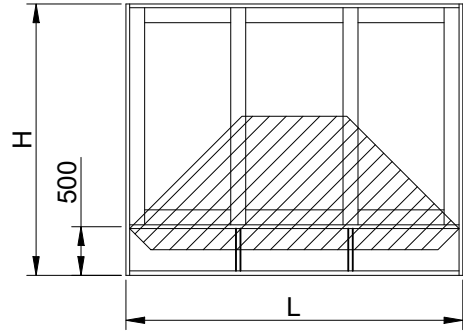

RE-22006		
Jy	95.581	mm ⁴
Wy	3.319	mm ³

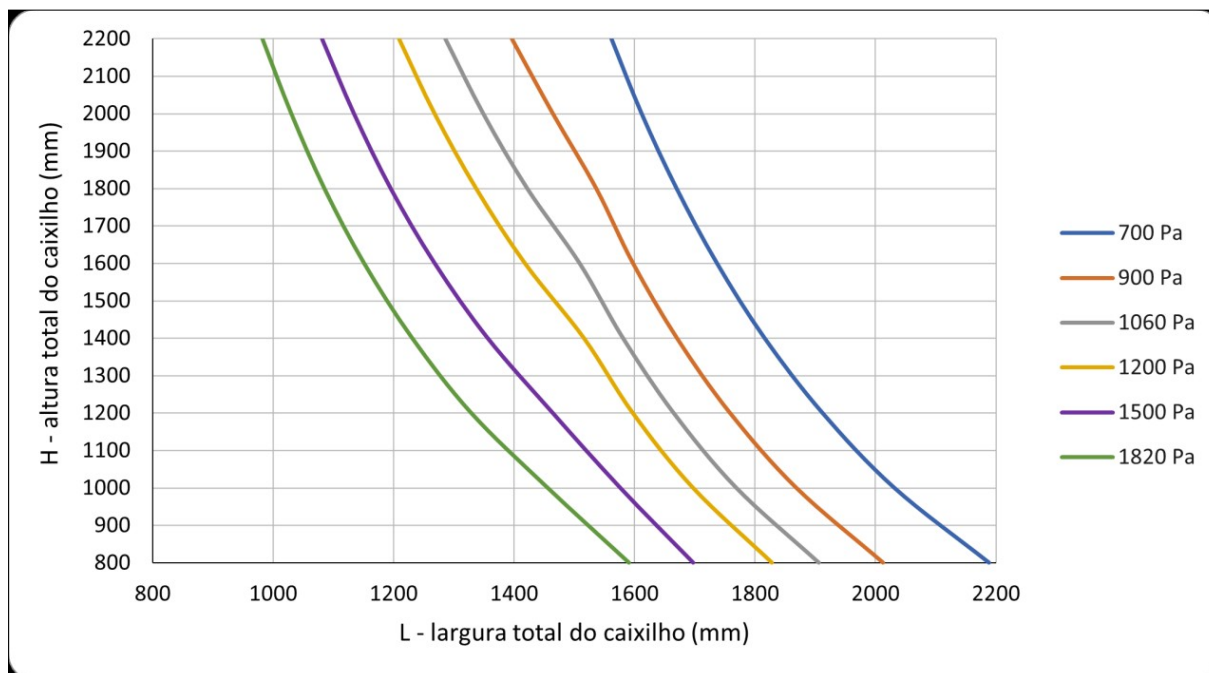
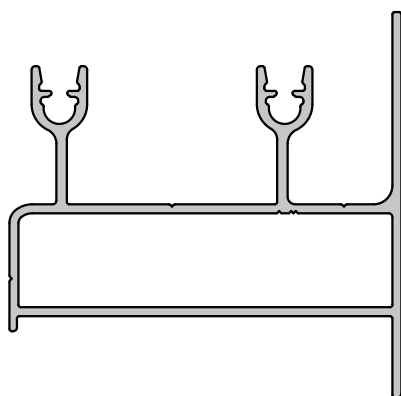
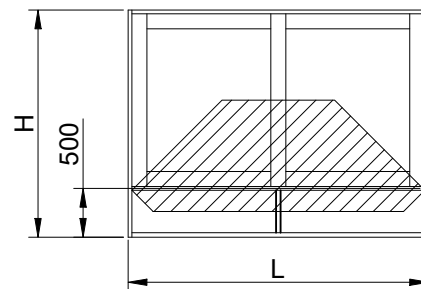

3

Perfis

ALG-1000	Marco Lateral Integrada	0,573 Kg/m	59
ALG-1001	Marco Superior Integrada	0,747 Kg/m	60
ALG-1004	Marco Lateral com Guia	0,906 Kg/m	65
ALG-1005	Guia da Persiana	0,577 Kg/m	65
ALG-1006	Tampa Interna Integrada	0,937 Kg/m	62
ALG-1007	Tampa Externa Integrada	0,867 Kg/m	61
ALG-1008	Guia Central	0,866 Kg/m	66
ALG-1009	Tampa Interna Integrada	1,260 Kg/m	64
ALG-1010	Tampa Externa Integrada	1,080 Kg/m	62
ALG-1013	Guia da Persiana	0,865 Kg/m	65
ALG-1014	Marco Lateral com Guia	1,273 Kg/m	65
ALG-1015	Guia Central com Reforço	2,112 Kg/m	66
ALG-1041	Tampa Interna Integrada	0,949 Kg/m	61
ALG-1042	Tampa Interna Integrada	1,973 Kg/m	63
ALG-27126	Trilho Inferior	0,347 Kg/m	58
ALG-895	Baguete	0,108 Kg/m	67
CX-3415	Travessa Inferior Integrada	0,732 Kg/m	61
CX-3678	Trilho Inferior Integrada	0,996 Kg/m	60
DS-238	Tubo Octogonal 40	0,485 Kg/m	60
MN-015	Tubo Octogonal 60	0,843 Kg/m	60
MN-050	Caixa do Recolhedor	0,738 Kg/m	59
MN-055	Terminal	0,376 Kg/m	66
P-633	Travessa Intermediária	0,550 Kg/m	67
P-639	Folha	0,343 Kg/m	67
RE-22001	Marco Superior 2 Planos	0,691 Kg/m	48
RE-22002	Marco Inferior 2 Planos	0,778 Kg/m	48
RE-22003	Marco Lateral 2 Planos	0,405 Kg/m	48
RE-22004	Marco Lateral 2 Planos	0,405 Kg/m	48
RE-22005	Travessa Superior 2 Planos	0,883 Kg/m	49
RE-22006	Travessa Inferior 2 Planos	0,766 Kg/m	49
RE-22007	Marco Liso 2 Planos	0,243 Kg/m	49
RE-22008	Marco Superior / Inferior 2 Planos	0,326 Kg/m	49
RE-22012	Trilho/ Travessa Inf. 2 Planos	0,893 Kg/m	50
RE-22021	Marco Superior 2 Planos	0,911 Kg/m	50
RE-22022	Marco Inferior 2 Planos	0,830 Kg/m	50
RE-22027	Marco Liso 2 Planos	0,491 Kg/m	50
RE-22101	Marco Superior 2 Planos	0,993 Kg/m	51
RE-22102	Trilho Inferior 3 Planos	1,141 Kg/m	51
RE-22103	Marco Lateral 3 Planos	0,693 Kg/m	52
RE-22104	Marco Lateral 3 Planos	0,530 Kg/m	52
RE-22105	Travessa Superior 3 Planos	1,307 Kg/m	52

RE-22107	Marco Liso 3 Planos	0,365 Kg/m	53
RE-22108	Marco Superior / Inferior 3 Planos	0,494 Kg/m	53
RE-22112	Trilho/ Travessa Inferior 3 Planos	1,333 Kg/m	53
RE-22201	Travessa Intermediária Integrada	0,793 Kg/m	54
RE-22202	Trilho Inferior Integrada	1,452 Kg/m	54
RE-22211	Travessa Intermediária Integrada	1,415 Kg/m	54
RE-22301	Montante Lateral / Central	0,541 Kg/m	55
RE-22302	Montante Lat. / Central Reforçado	0,872 Kg/m	55
RE-22303	Montante Lat. / Central Reforçado	1,044 Kg/m	56
RE-22304	Montante Lat. / Central Reforçado	0,778 Kg/m	56
RE-22401	Montante Mão de Amigo	0,382 Kg/m	55
RE-22402	Montante Mão de Amigo Reforçado	0,530 Kg/m	55
RE-22403	Montante Mão de Amigo Reforçado	0,878 Kg/m	56
RE-22404	Montante Mão de Amigo Reforçado	0,613 Kg/m	56
RE-22405	Mão de Amigo 3 folhas	0,435 Kg/m	57
RE-22501	Travessa	0,437 Kg/m	57
RE-22502	Travessa Inferior	0,917 Kg/m	57
RE-22503	Travessa Intermediária	0,503 Kg/m	57
RE-22901	Trilho	0,069 Kg/m	57
RE-22902	Mata Junta Lateral	0,218 Kg/m	58
RE-22903	Mata Junta Central	0,306 Kg/m	58
RE-22904	Veda Vento	0,328 Kg/m	58
RE-221000	Marco Lateral Integrada	0,503 Kg/m	58
RE-221001	Marco Superior Integrada	0,774 Kg/m	59
RE-223415	Marco Inferior Integrada	0,764 Kg/m	59
U-1230	Baguete	0,114 Kg/m	67
US-294	Veneziana Ventilada	0,269 Kg/m	67
Z-284	Veneziana	0,269 Kg/m	67

RE-22001	Marco Superior 2 Planos
	0,691 Kg/m

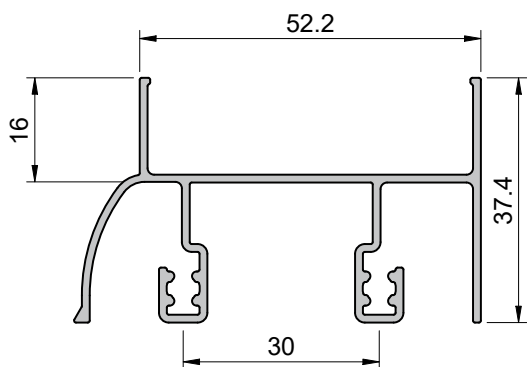
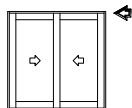

RE-22002	Marco Inferior 2 Planos
	0,778 Kg/m

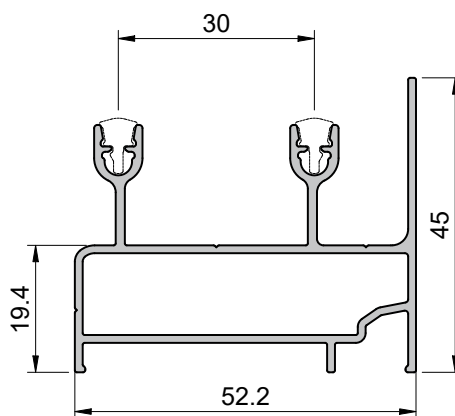
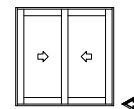

RE-22003	Marco Lateral 2 Planos
	0,405 Kg/m

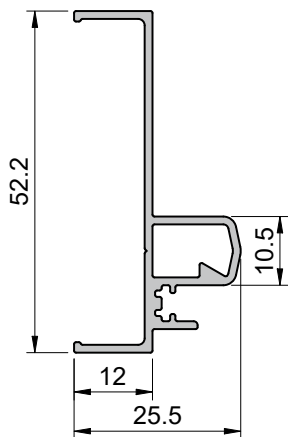
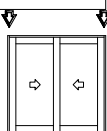

RE-22004	Marco Lateral 2 Planos
	0,405 Kg/m

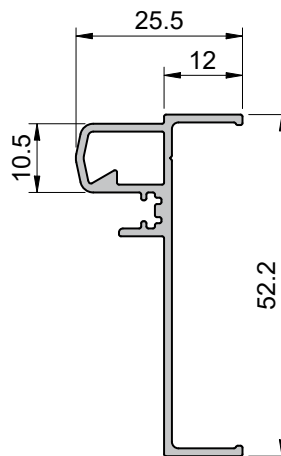
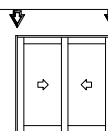

RE-22005	Travessa Superior 2 Planos
	0,883 Kg/m
Jy = 130.025 mm ⁴ Wy = 3.732 mm ³	

RE-22006	Travessa Inferior 2 Planos
	0,766 Kg/m
Jy = 95.581 mm ⁴ Wy = 3.319 mm ³	

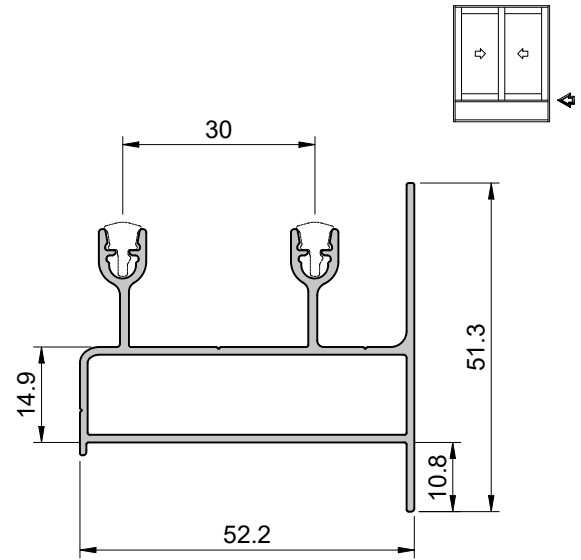
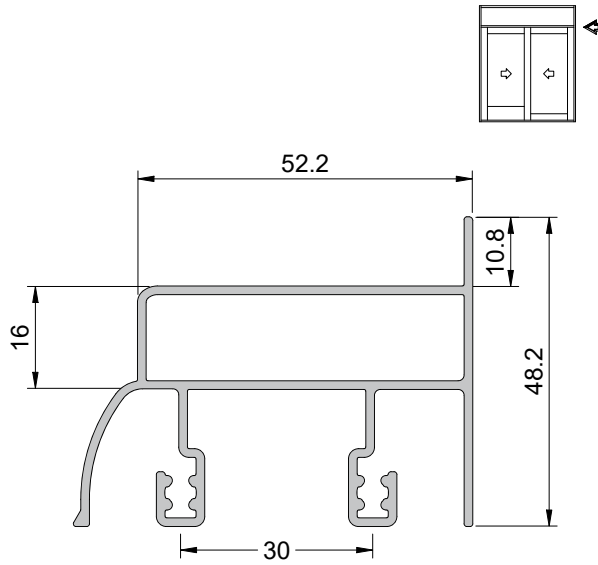

RE-22007	Marco Liso 2 Planos
	0,243 Kg/m

RE-22008	Marco Superior / Inferior 2 Planos
	0,326 Kg/m

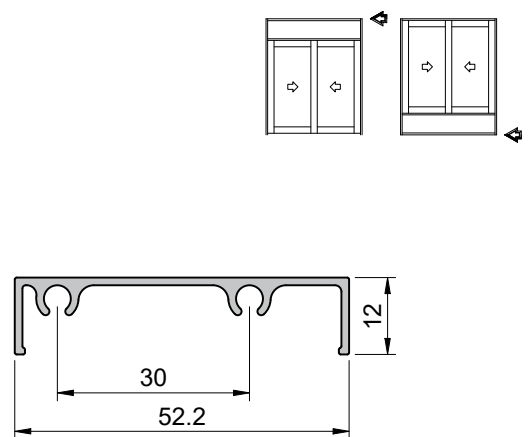
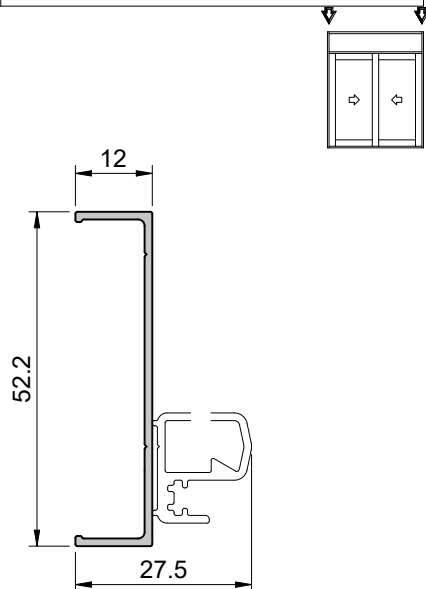

RE-22012	Trilho/ Travessa Inf. 2 Planos
	0,893 Kg/m

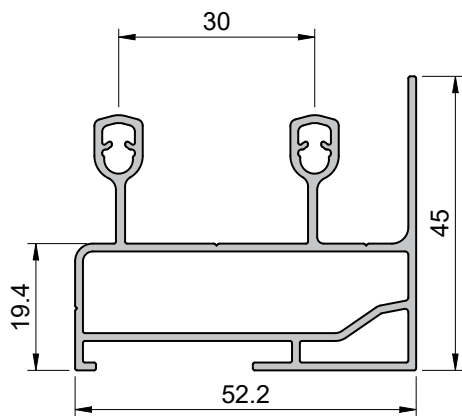
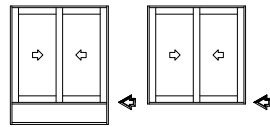

RE-22021	Marco Superior 2 Planos
	0,911 Kg/m

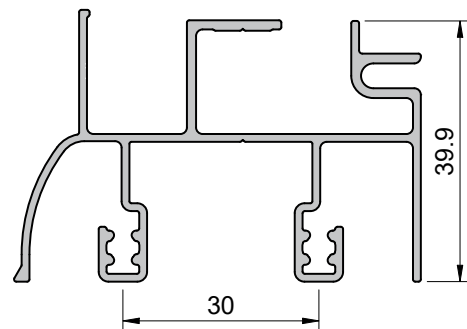
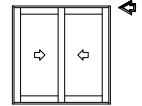

RE-22022	Marco Inferior 2 Planos
	0,830 Kg/m

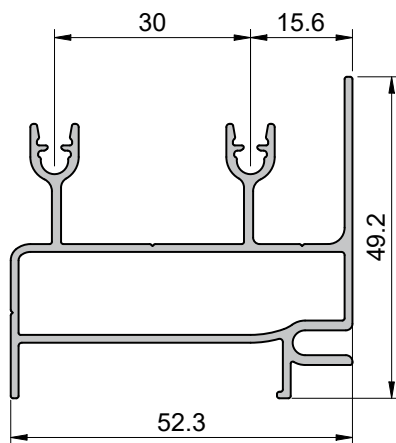
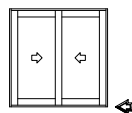

RE-22027	Marco Liso 2 Planos
	0,491 Kg/m

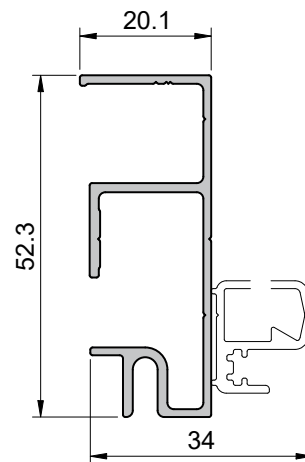
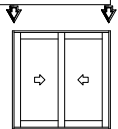

RE-22101	Marco Superior 2 Planos
	0,993 Kg/m

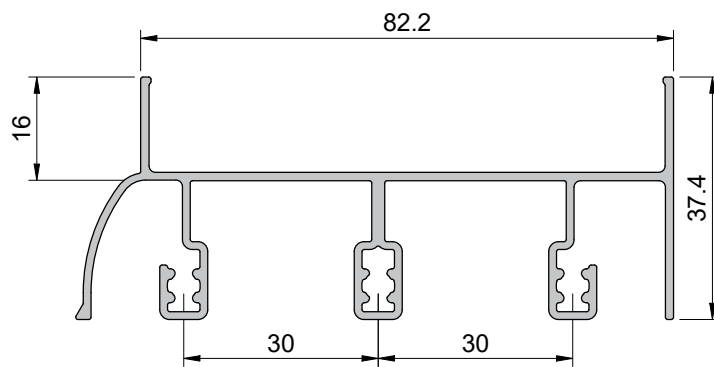
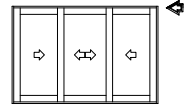

RE-22102	Trilho Inferior 3 Planos
	1,141 Kg/m

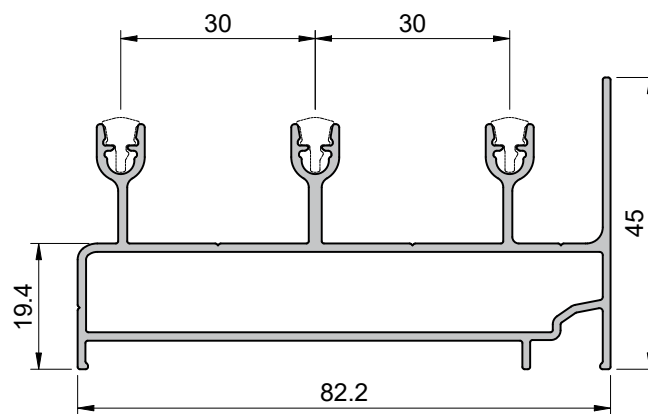
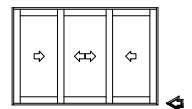

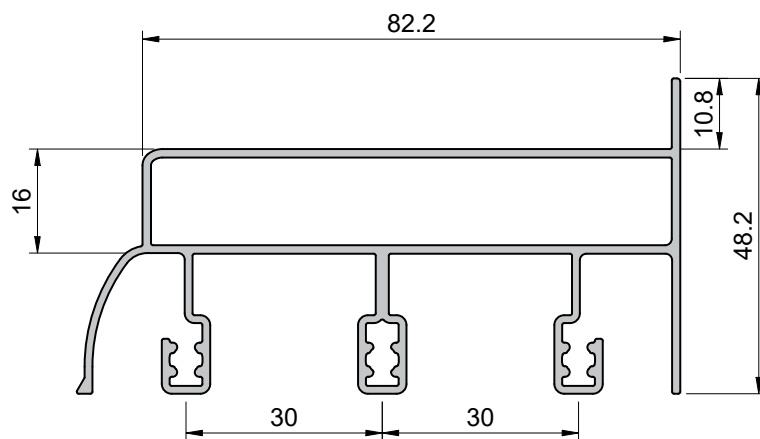
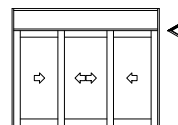
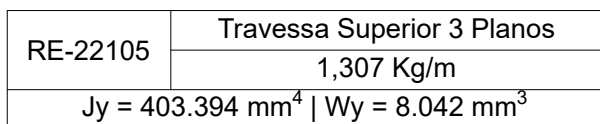
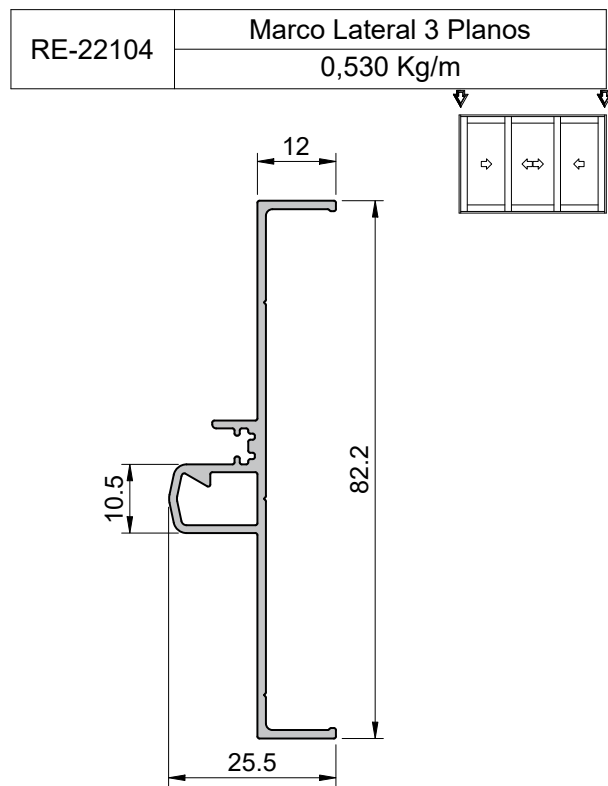
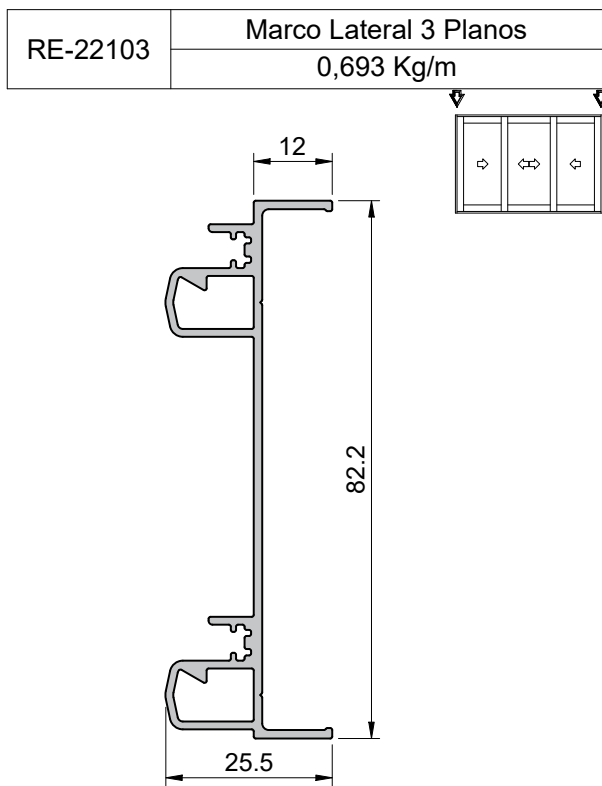

RE-22107	Marco Liso 3 Planos
	0,365 Kg/m

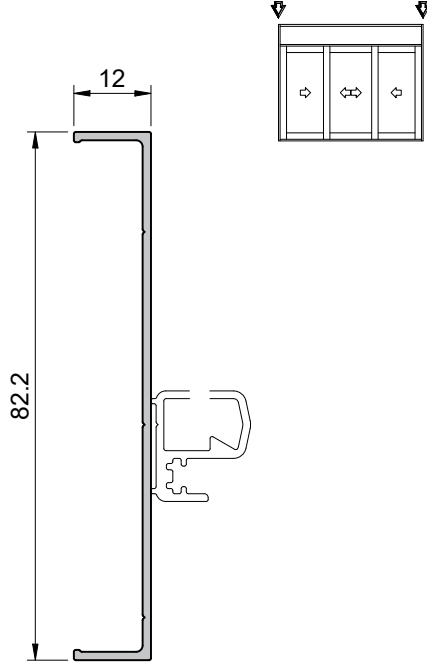

RE-22108	Marco Superior / Inferior 3 Planos
	0,494 Kg/m

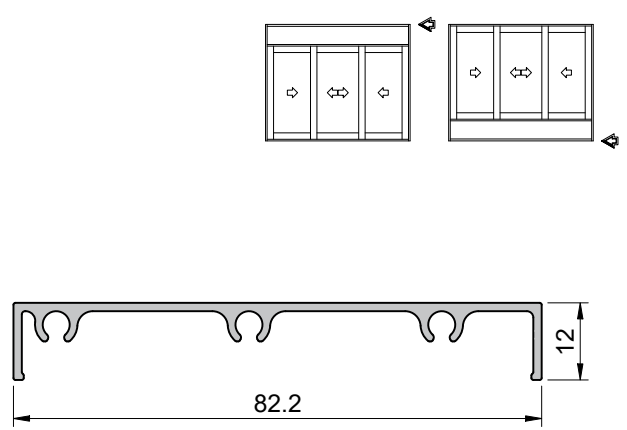

RE-22112	Trilho/ Travessa Inferior 3 Planos
	1,333 Kg/m

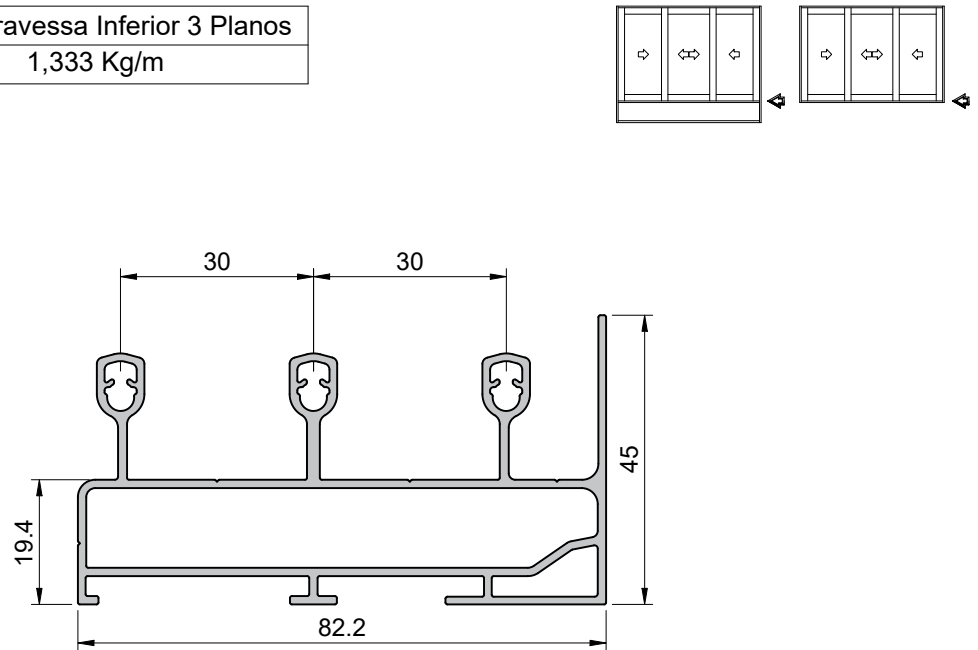

RE-22201	Travessa Intermediária Integrada
	0,793 Kg/m
$J_y = 199.139 \text{ mm}^4 \mid W_y = 4.261 \text{ mm}^3$	

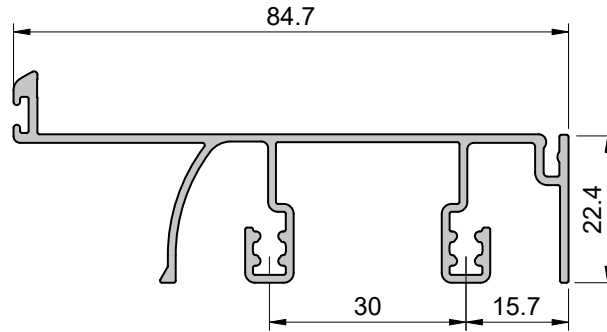
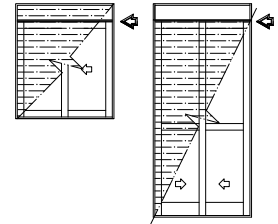

RE-22202	Trilho Inferior Integrada
	1,452 Kg/m

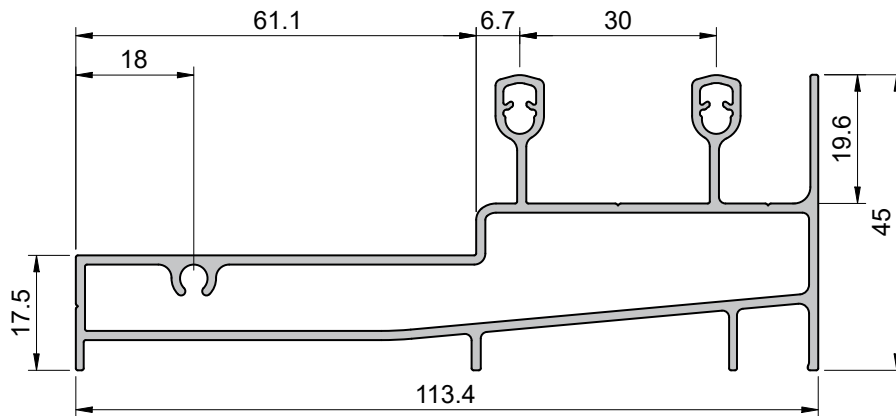
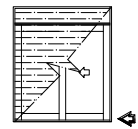

RE-22211	Travessa Intermediária Integrada
	1,415 Kg/m
$J_y = 397.898 \text{ mm}^4 \mid W_y = 8.780 \text{ mm}^3$	

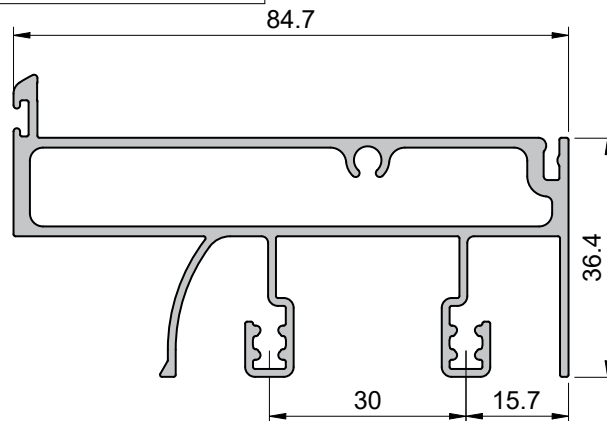
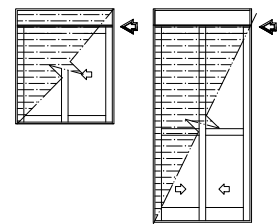

RE-22301	Montante Lateral / Central
	0,541 Kg/m
Jx = 16.611 mm ⁴ Wx = 1.474 mm ³	

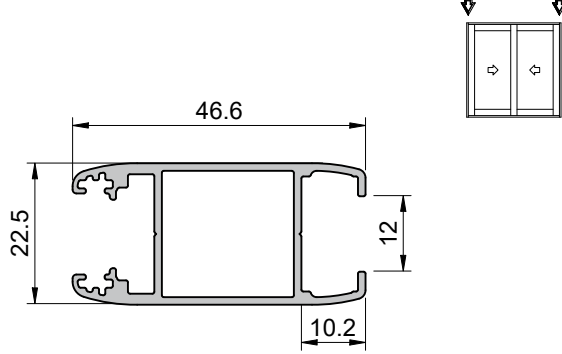

RE-22401	Montante Mão de Amigo
	0,382 Kg/m
Jx = 13.644 mm ⁴ Wx = 924 mm ³	

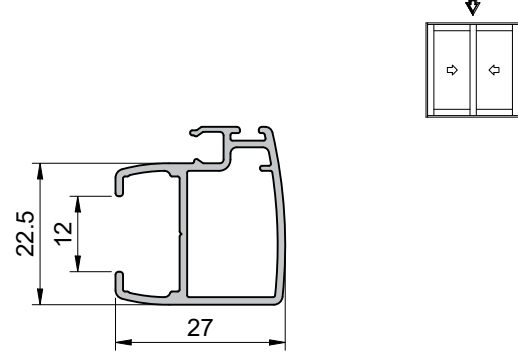

RE-22302	Montante Lat. / Central Reforçado
	0,872 Kg/m
Jx = 147.402 mm ⁴ Wx = 3.819 mm ³	

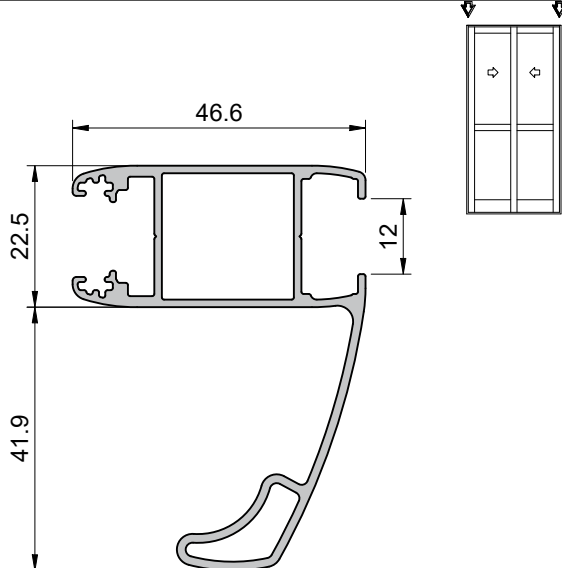

RE-22402	Montante Mão de Amigo Reforçado
	0,708 Kg/m
Jx = 141.110 mm ⁴ Wx = 3.862 mm ³	

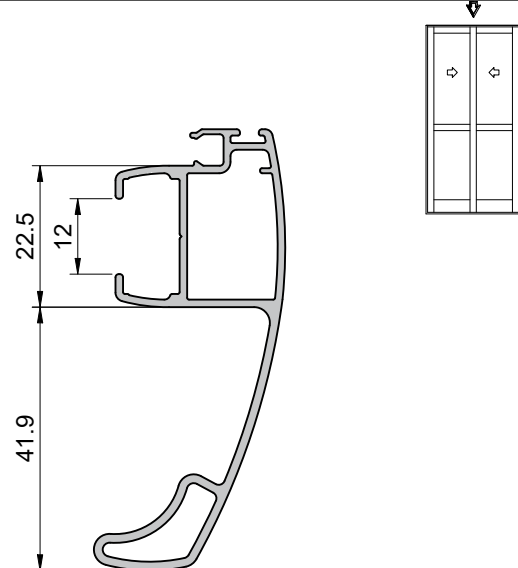

RE-22303	Montante Lat. / Central Reforçado
	1,044 Kg/m
Jx = 239.652 mm ⁴ Wx = 5.837 mm ³	

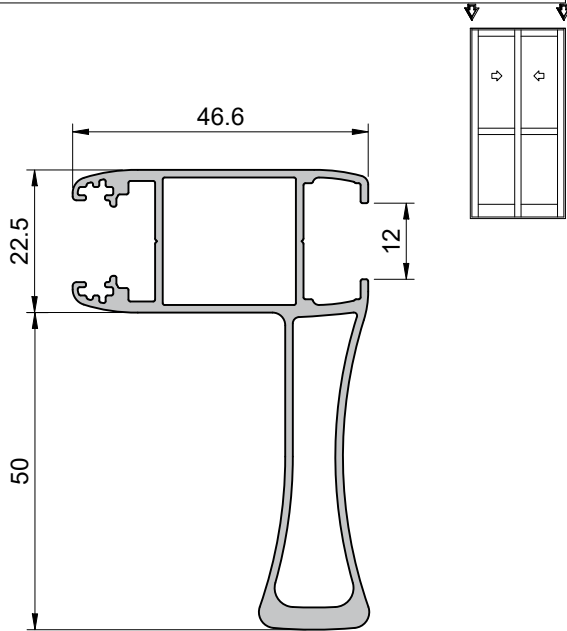

RE-22403	Montante Mão de Amigo Reforçado
	0,878 Kg/m
Jx = 223.670 mm ⁴ Wx = 5.590 mm ³	

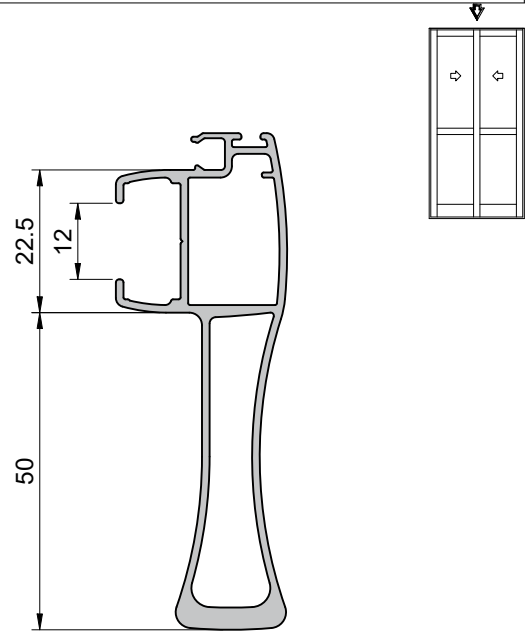

RE-22304	Montante Lat. / Central Reforçado
	0,778 Kg/m
Jx = 74.620 mm ⁴ Wx = 2.461 mm ³	

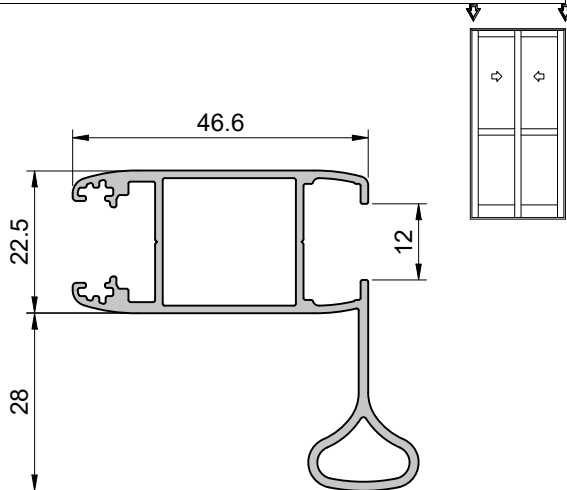

RE-22404	Montante Mão de Amigo Reforçado
	0,613 Kg/m
Jx = 73.307 mm ⁴ Wx = 2.489 mm ³	

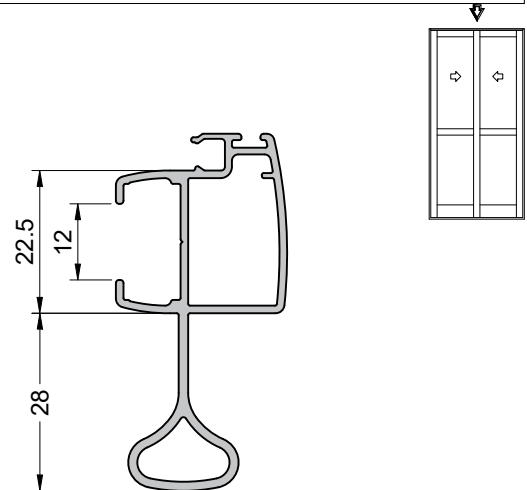

RE-22405	Mão de Amigo 3 folhas
	0,435 Kg/m
Jx = 19.503 mm ⁴ Wx = 1.142 mm ³	

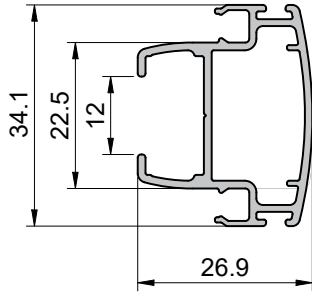
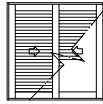

RE-22501	Travessa
	0,437 Kg/m

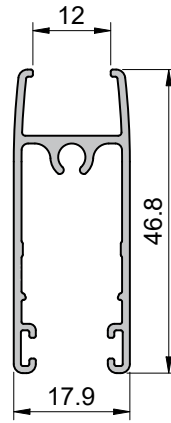
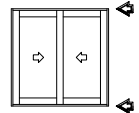

RE-22502	Travessa Inferior
	0,917 Kg/m

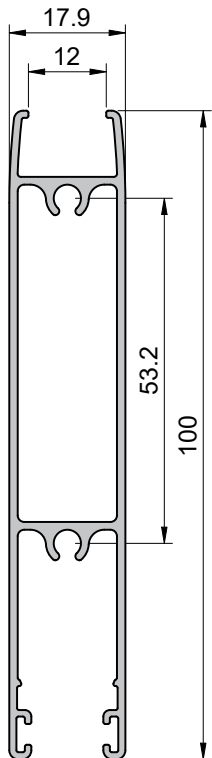
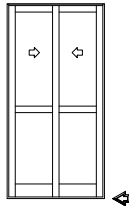

RE-22503	Travessa Intermediária
	0,503 Kg/m

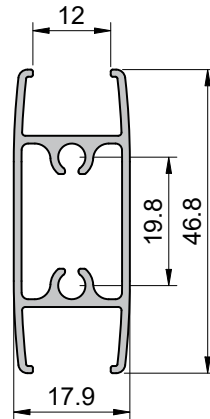
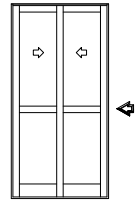

RE-22901	Trilho
	0,069 Kg/m

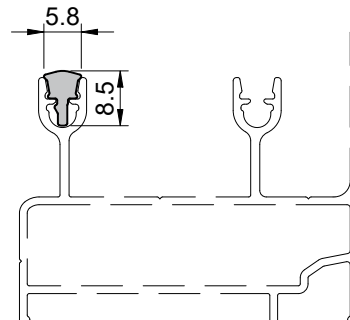
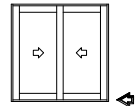

RE-22902	Mata Junta Lateral
	0,218 Kg/m

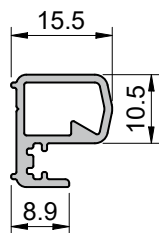
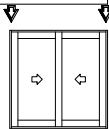

RE-22903	Mata Junta Central
	0,306 Kg/m

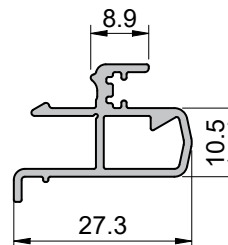
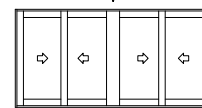

RE-22904	Veda Vento
	0,328 Kg/m

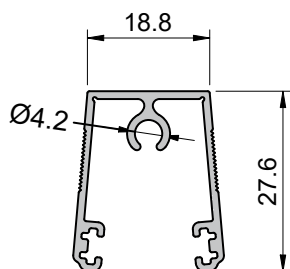

RE-221000	Marco Lateral Integrada
	0,503 Kg/m

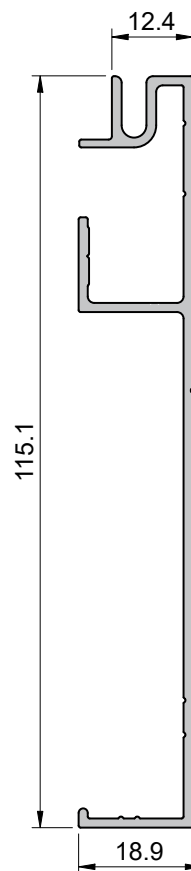
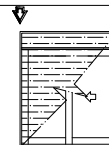

ALG-27126	Trilho Inferior
	0,347 Kg/m

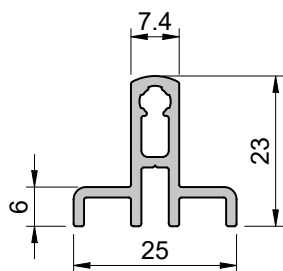
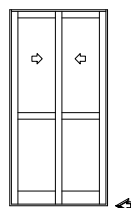

RE-221001	Marco Superior Integrada
	0,774 Kg/m

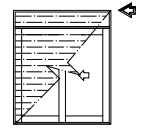
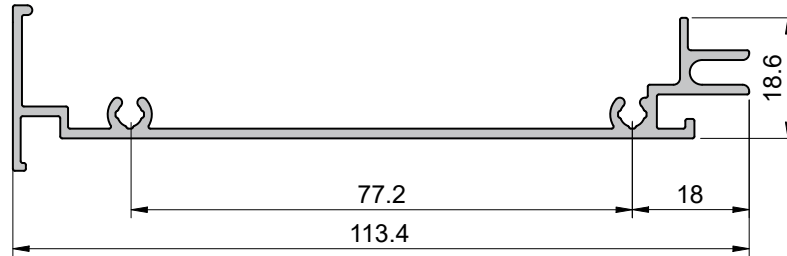

RE-223415	Marco Inferior Integrada
	0,764 Kg/m

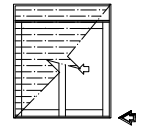
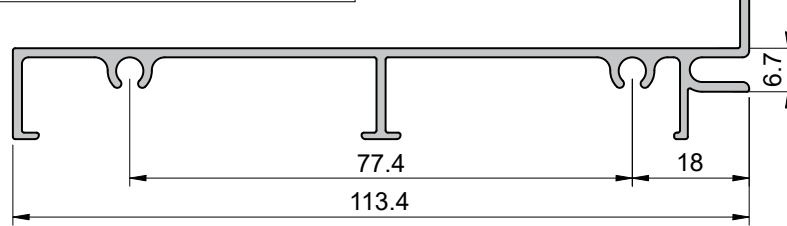

ALG-1000	Marco Lateral Integrada
	0,573 Kg/m

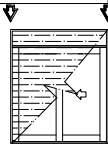
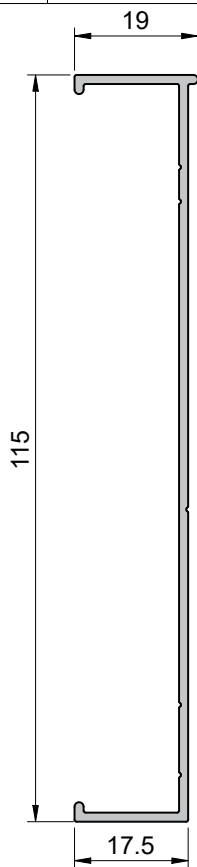

MN-050	Caixa do Recolhedor
	0,738 Kg/m

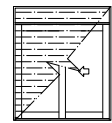
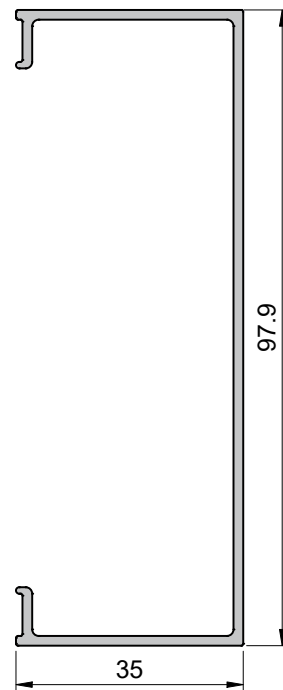

ALG-1001	Marco Superior Integrada
	0,747 Kg/m

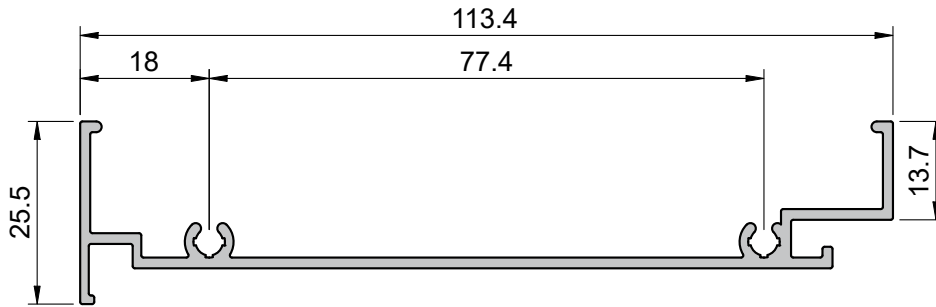
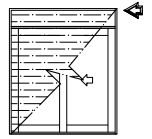

CX-3678	Trilho Inferior Integrada
	0,996 Kg/m

* O uso deste perfil reduz o desempenho do conjunto

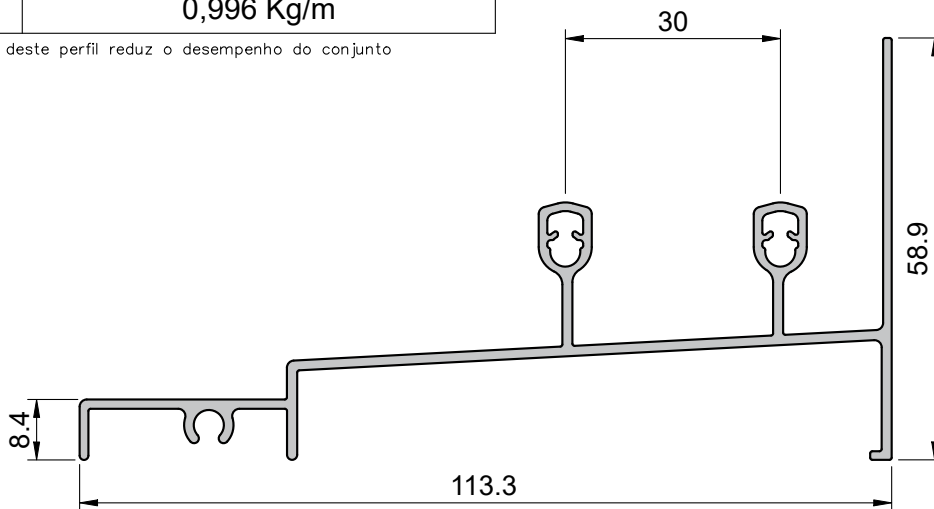
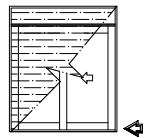

DS-238	Tubo Octogonal 40
	0,485 Kg/m

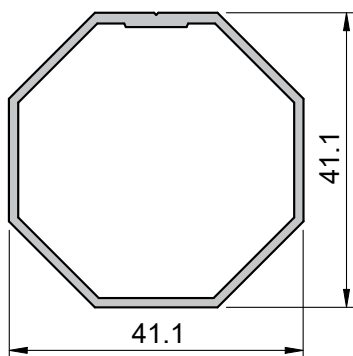

MN-015	Tubo Octogonal 60
	0,843 Kg/m

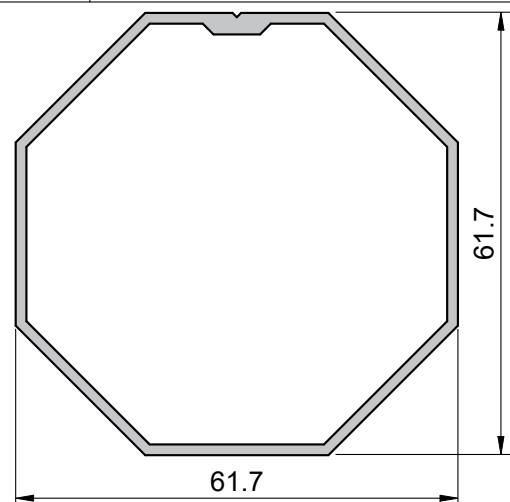

ALG-1007	Tampa Externa Integrada
	0,867 Kg/m

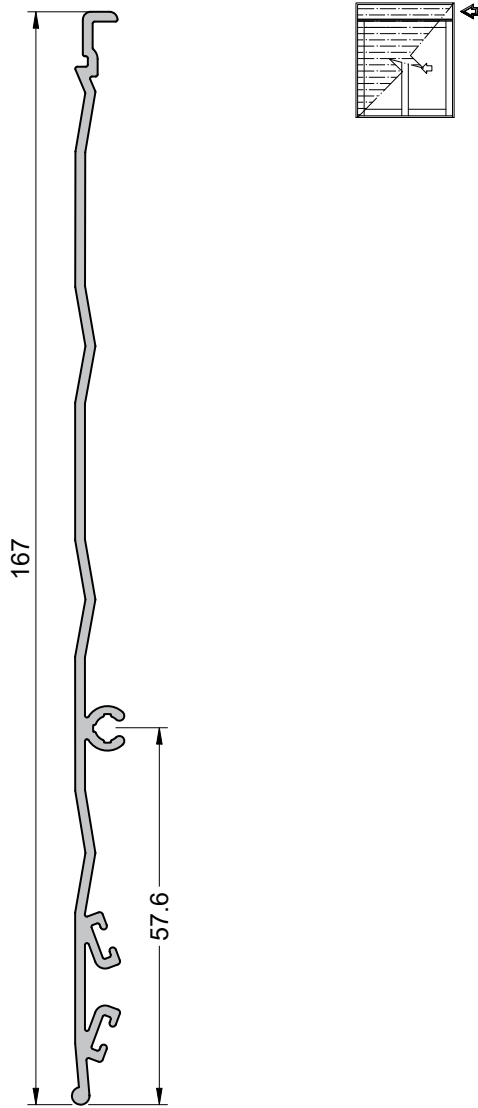

ALG-1041	Tampa Interna Integrada
	0,949 Kg/m

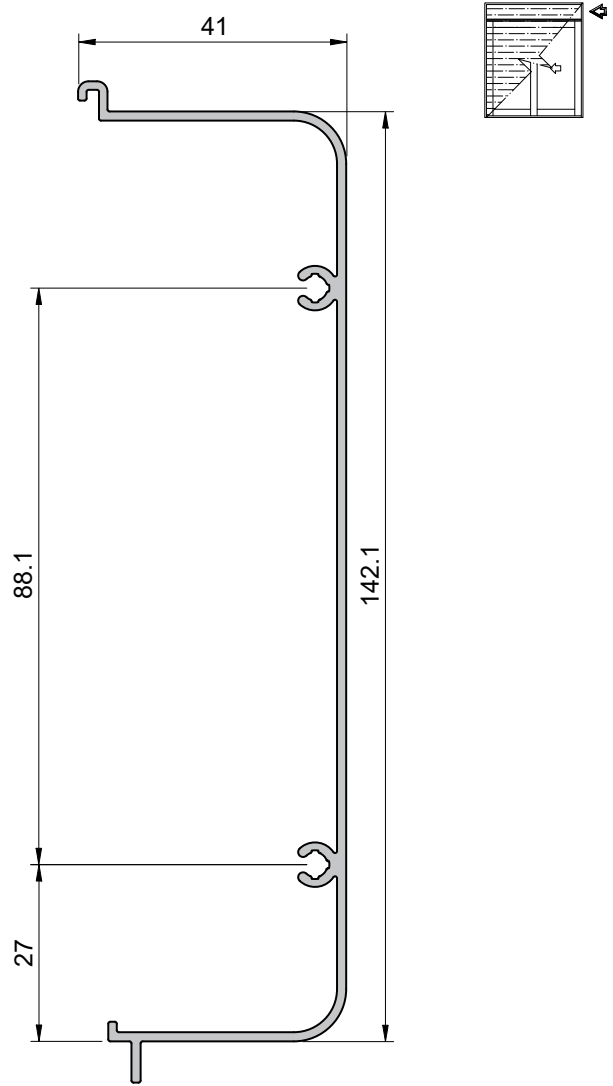

CX-3415	Travessa Inferior Integrada
	0,732 Kg/m

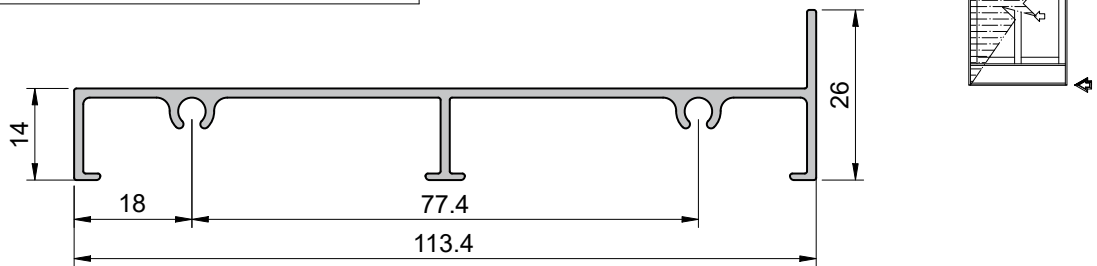

ALG-1006	Tampa Interna Integrada
	0,937 Kg/m

ALG-1010	Tampa Externa Integrada
	1,080 Kg/m

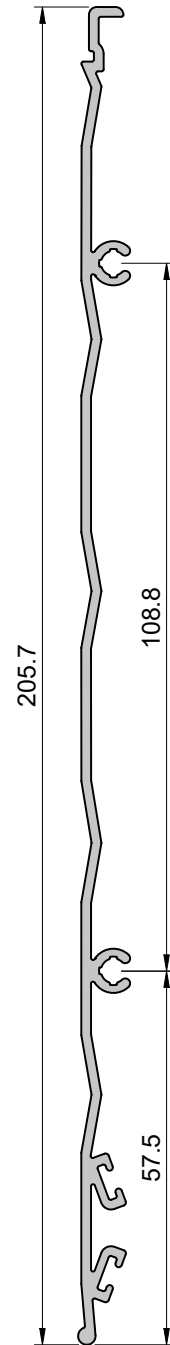
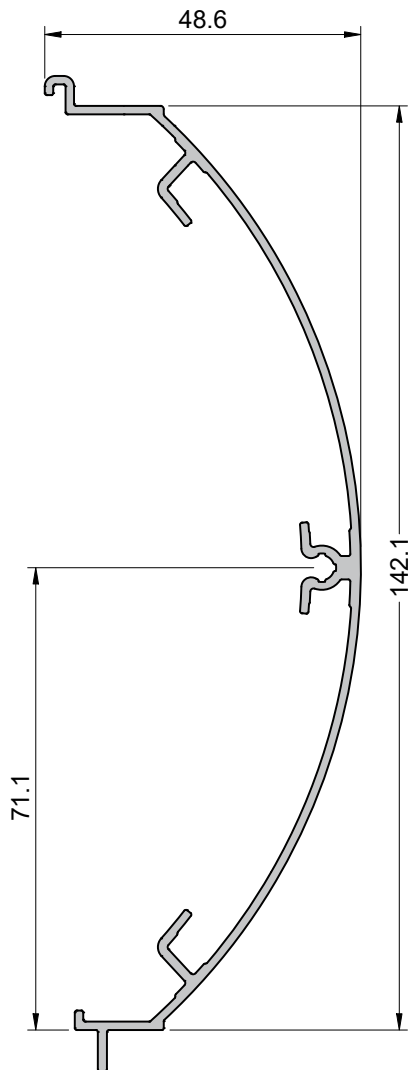
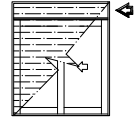
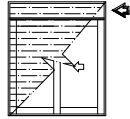

ALG-1042	Tampa Interna Integrada
	1,973 Kg/m

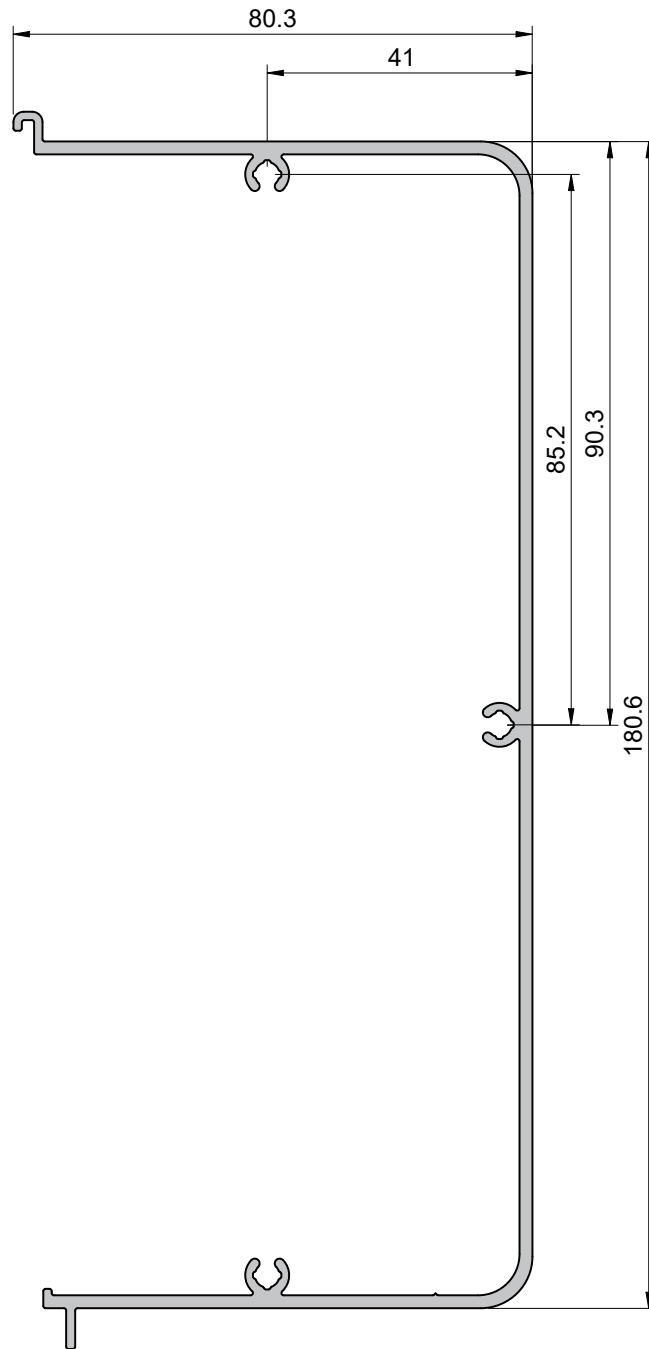
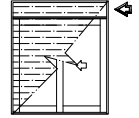

ALG-1009	Tampa Interna Integrada
	1,260 Kg/m

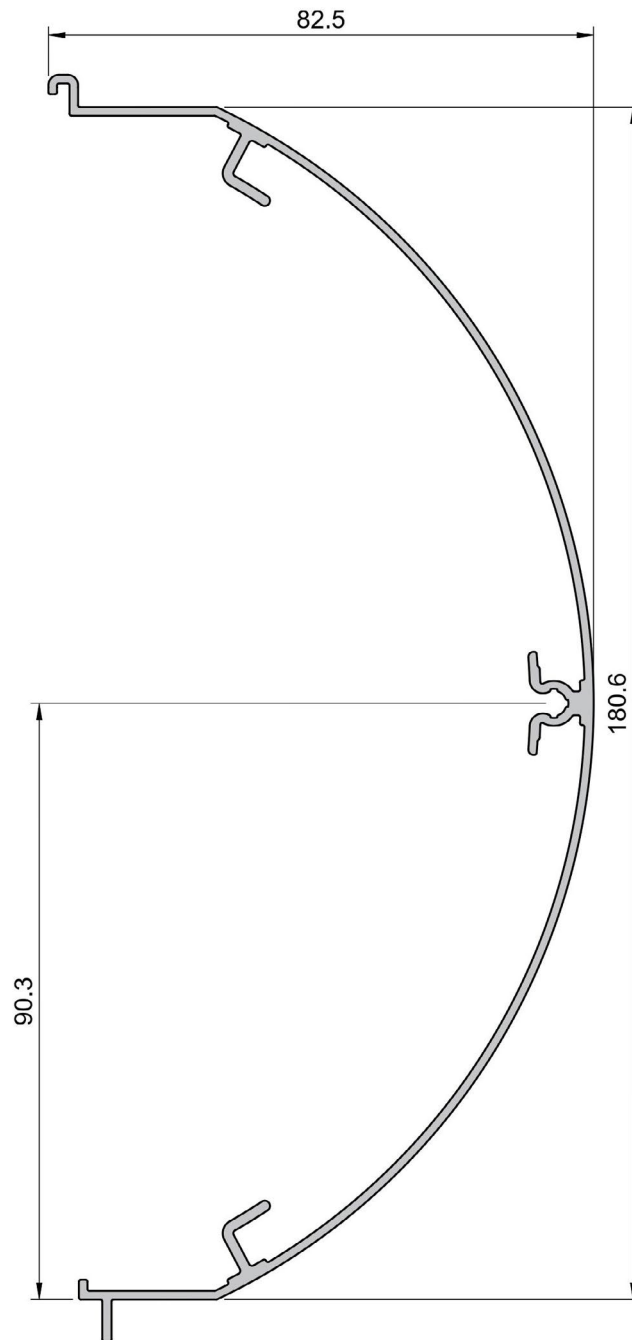
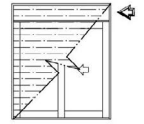

ALG-1004	Marco Lateral com Guia
	0,906 Kg/m

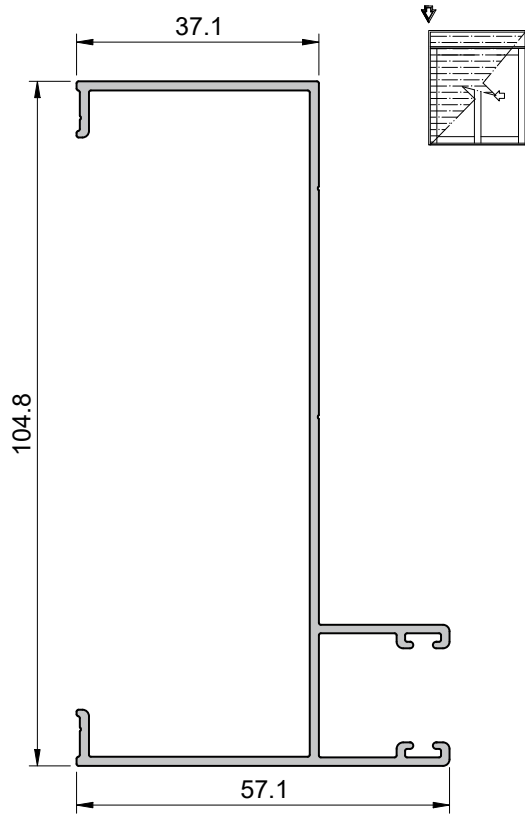

ALG-1014	Marco Lateral com Guia
	1,273 Kg/m

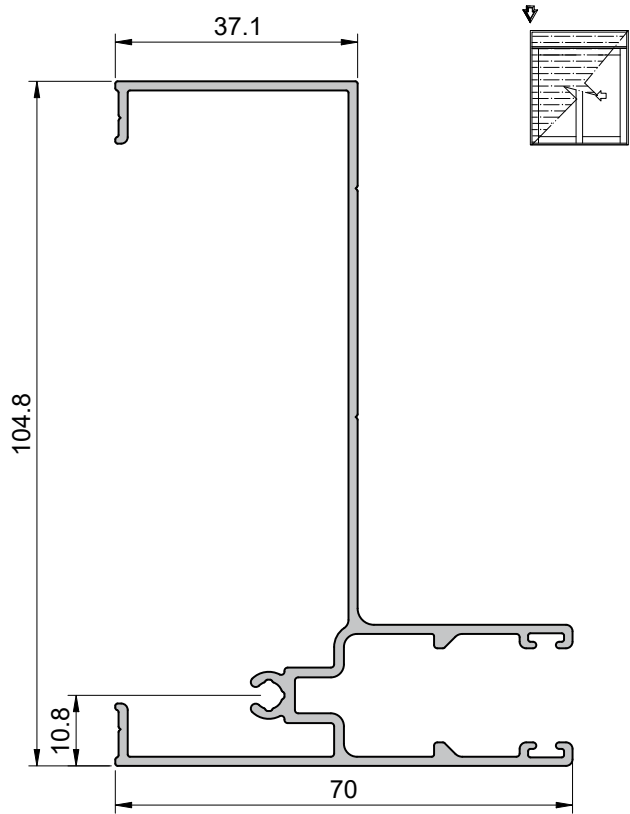

ALG-1005	Guia da Persiana
	0,577 Kg/m

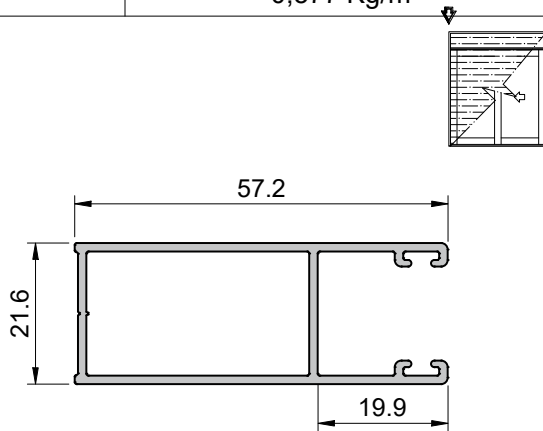

ALG-1013	Guia da Persiana
	0,856 Kg/m

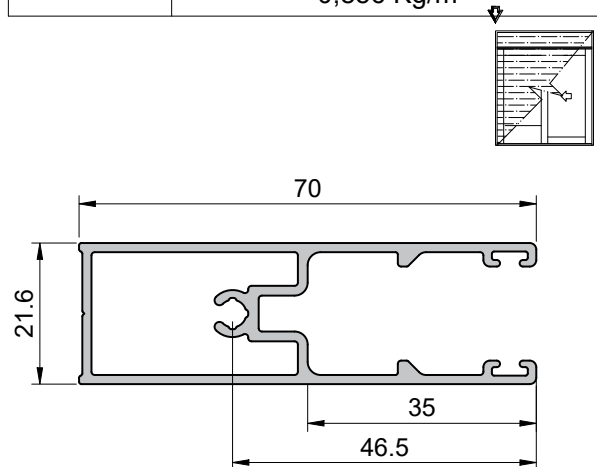

ALG-1015	Guia Central com Reforço
	2,112 Kg/m
Jx = 454.478 mm ⁴ Wx = 10.240 mm ³	

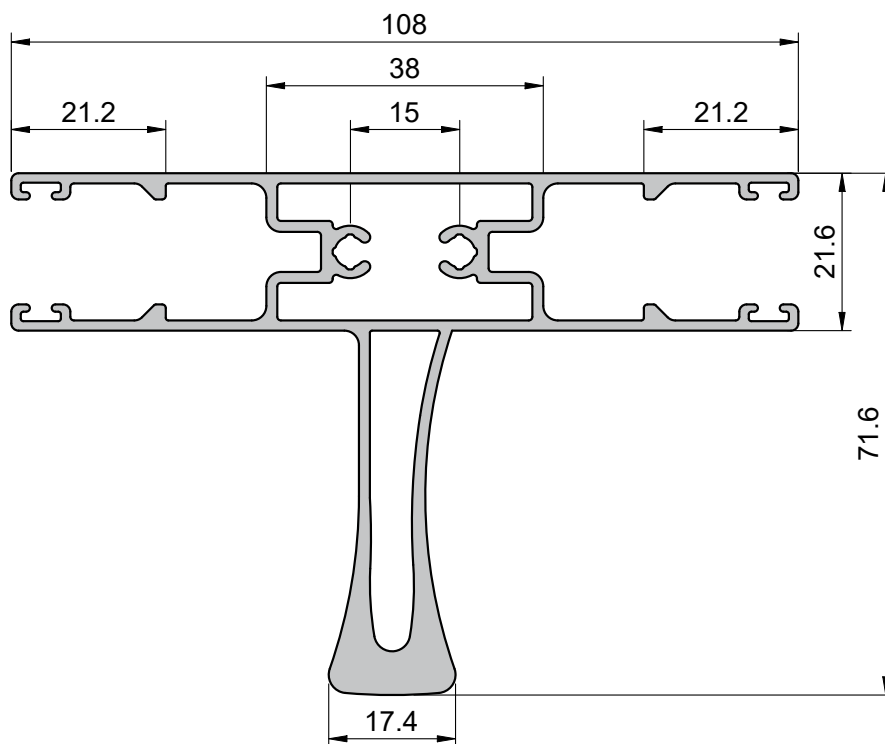

ALG-1008	Guia Central
	0,866 Kg/m

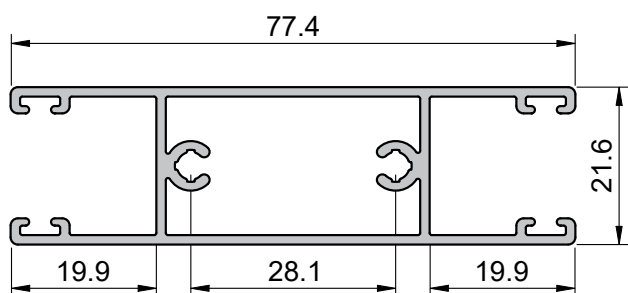

MN-055	Terminal
	0,376 Kg/m

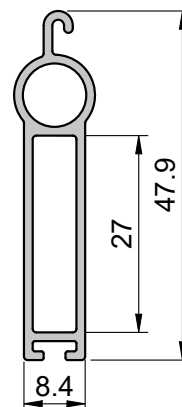

P-633	Travessa Intermediária
	0,550 Kg/m

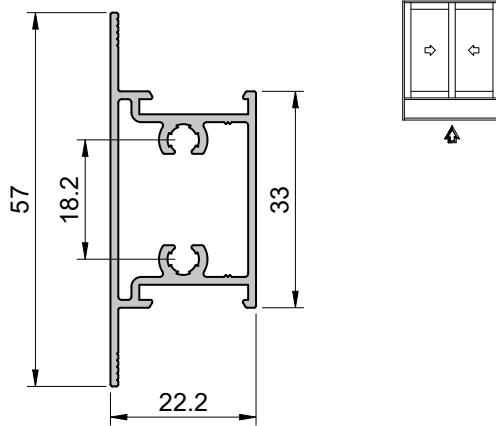

P-639	Folha
	0,343 Kg/m

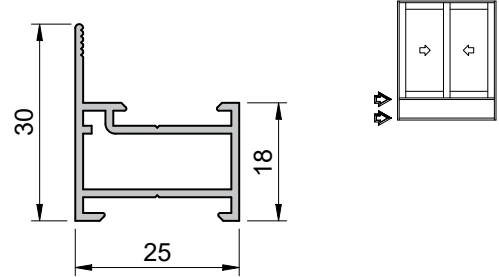

ALG-895	Baguete
	0,108 Kg/m

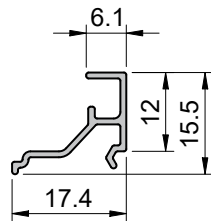

U-1230	Baguete
	0,114 Kg/m

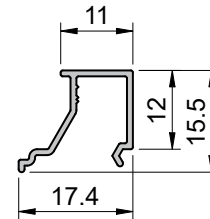

Z-284	Veneziana
	0,269 Kg/m

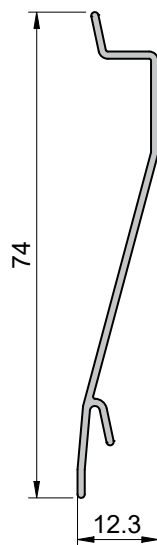

US-294	Veneziana Ventilada
	0,269 Kg/m

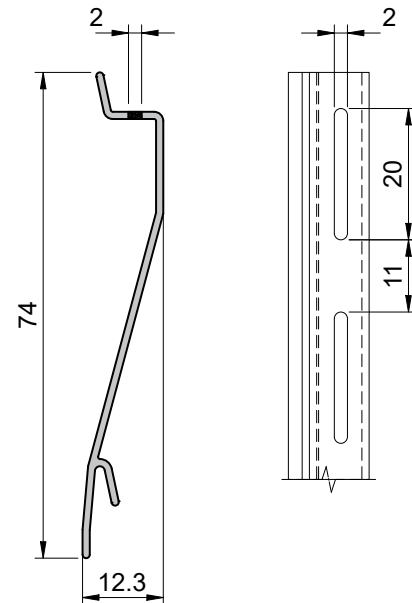

4

Componentes

IMAGENS / DESCRIÇÕES

BT-615	Espuma EPDM		93
BTE-0001	Batedeira de Folha		78
BTE-0007	Batedeira de Trilho (Usinado)		78
BTE-0008	Batedeira de Trilho (Sobreposto)		78
CAL-0001	Calço Folha Fixa		82
CBD-0001	Chumbador de Aço Zincado	CM-060/ CM-063/ CM-174	90
CBD-0002	Chumbador de Aço Zincado	CM-060/ CM-063	90
CHC-0001	Concha Cega Janela Fix. Ap.		83
CHC-0002	Concha Cega Porta Fix. Ap.		83
CHC-0003	Concha Cega Janela		83
CHC-0004	Concha Cega Porta		83
CTF-0001	Contra Fecho Lateral / Central		87
DAP-0001	Disco alinhador da persiana	Aplicação Perfil DS-238	103
DAP-0002	Disco alinhador da persiana	Aplicação Perfil DS-238	103
DAP-0003	Disco alinhador da persiana	Aplicação Perfil MN-015	103
DAP-0004	Disco alinhador da persiana	Aplicação Perfil MN-015	103
DAP-0005	Disco alinhador da persiana	Aplicação Perfil MN-015	103
DRN-22001	Dreno Flap Saída d'Água		81
DRN-22002	Dreno Flap		81
DRN-22012	Saída d'Água		81
ECV-0001	Escova de Vedação 5x6mm		91
ECV-0001B	Escova de Ved. 5x6mm C/ Barreira		91
ECV-0004	Escova de Vedação 5x7mm		108
ECV-0006	Escova de Vedação 5x8mm		107
ECV-0006B	Escova de Ved. 5x8mm C/ Barreira		107
ECV-0010	Escova de Vedação 5x4mm		91
ECV-0010B	Escova de Ved. 5x4mm C/ Barreira		91
ECV-0011	Escova de Vedação 5x12mm		107
ECV-0011B	Esc. de Ved. 5x12mm C/Barreira		107
ESP-1103	Guarnição de EPDM		92
ESP-1106	Guarnição de EPDM		92
ESP-1118	Espuma de PVC 11x1,8mm		90
ESP-1406	Guarnição de PVC 14X6mm		93
FCH-0001	Fecho Janela com Chave Fix. Ap		84
FCH-0002	Fecho Janela sem Chave Fix. Ap		84
FCH-0003	Fecho Porta com Chave Fix. Ap		85
FCH-0004	Fecho Porta sem Chave Fix. Ap		85
FCH-0005	Fecho Janela com Chave		86
FCH-0006	Fecho Janela sem Chave		86
FCH-0026	Fecho Porta com Chave		86
FCH-0027	Fecho Porta sem Chave		86

FCH-0038	Fecho Cremona		89
FPE-0001	Fixador da Esteira		103
GCT-0003	Guia Inferior da Cinta		96
GCT-0004	Guia Frontal da Cinta		96
GCT-0005	Guia Frontal da Cinta Reta		97
GDE-22001	Guia Deslizante Mão de Amigo		77
GDE-22002	Guia Deslizante Lateral		77
GNC-0001	Guarnição de EPDM		91
GPE-0002	Guia Limitador da Esteira		98
GPE-0005	Guia da Esteira		97
GPE-0006	Guia da Esteira		97
GXT-1123	Guarnição de EPDM		92
GXT-1124	Guarnição de EPDM		92
GXT-1127	Guarnição de EPDM		93
GXT-1128	Guarnição de EPDM		93
GXT-1155	Guarnição de EPDM		108
GXT-1157	Guarnição de EPDM		93
JTV-0025	Junta de Vedação	Aplicação Perfil ALG-1001	84
JTV-0026	Junta de Vedação	Aplicação Perfil ALG-1007	85
JTV-0027	Junta de Vedação	Aplicação Perfil ALG-1010	85
JTV-22001	Junta de Vedação	Aplicação Perfil RE-22001	72
JTV-22002	Junta de Vedação	Aplicação Perfil RE-22002	72
JTV-22005	Junta de Vedação	Aplicação Perfil RE-22005	72
JTV-22006	Junta de Vedação	Aplicação Perfil RE-22006	72
JTV-22008	Junta de Vedação	Aplicação Perfil RE-22008	74
JTV-22101	Junta de Vedação	Aplicação Perfil RE-22101	72
JTV-22102	Junta de Vedação	Aplicação Perfil RE-22102	73
JTV-22105	Junta de Vedação	Aplicação Perfil RE-22105	73
JTV-22106	Junta de Vedação	Aplicação Perfil RE-22106	73
JTV-22108	Junta de Vedação	Aplicação Perfil RE-22108	74
JTV-22201	Junta de Vedação	Aplicação Perfil RE-22201	74
JTV-3415	Junta de Vedação	Aplicação Perfil CX-3415	74
LPE-0001	Limitador da Esteira		98
MTA-0001	Manta Acústica	Isolamento da Caixa da Persiana	96
P020010	Espuma PVC de Célula Fechadas		93
PAC-0001	Palheta Cega 41mm		98
PAC-0002	Palheta Cega 41mm		98
PAC-0003	Palheta Cega 41mm		98
PAV-0001	Palheta Ventilada 41mm		98
PAV-0002	Palheta Ventilada 41mm		98
PAV-0003	Palheta Ventilada 41mm		98

PCP-4213	Parf. Cab. Pan. 4,2x13 Aço Inox		109
PCP-4225	Parf. Cab. Pan. 4,2x25 Aço Inox		108
PCP-4832PL	Parf. Cab. Pan. 4,8x32 PL Aço Inox		108
PRT-0002	Presilha de Arremate		79
QL-5375	Qlon de Vedação 5,3x7,5mm		91
RCO-0001	Recolhedor Manual Janela		99
RCO-0002	Recolhedor Manual Porta		100
RLD-22001	Roldana Simples com Rolamento	Polimero : 30kg Por Folha (Máx)	94
RLD-22002	Roldana Dupla com Rolamento	Polimero : 60kg Por Folha (Máx)	95
RLD-22011	Roldana Simples com Rolamento	Polimero : 40kg Por Folha (Máx)	94
RLD-22012	Roldana Dupla com Rolamento	Aluminio : 60kg Por Folha (Máx)	95
RLD-22111	Roldana Simples com Rolamento	Polimero : 15kg Por Folha (Máx)	94
RLD-22112	Roldana Simples com Rolamento	Polimero : 40kg Por Folha (Máx)	95
TMT-0001	Tampa Montante		76
TMT-0002	Tampa Montante		76
TMT-0004	Botão Tampa Furo		79
TMT-0005	Tampa Caixa Integrada Janela		104
TMT-0006	Tampa Caixa Integrada Janela		104
TMT-0007	Tampa Caixa Integrada Porta		105
TMT-0008	Tampa Caixa Integrada Porta		106
TMT-0021	Tampa Montante		76
TRL-0001	Trilho de Poliamida		90
TRV-22001	Lingueta da Concha Trad.		88
TRV-22002	Lingueta da Concha Touch		88
TRV-22003	Trava Folha Fixa		82
VDA-0011	Lã Pet Para Isolamento Acustico		88
VDA-22001	Vedação Sup/Inf.		80
VDA-22002	Vedação Sup/Inf.	Aluminio	79
VDA-22003	Vedação Sup/Inf.		80
VDA-22005	Espuma de Polietileno		89
VDA-22011	Vedação Sup/Inf.		80

JTV-22001	Junta de vedação
	aplicação perfil RE-22001

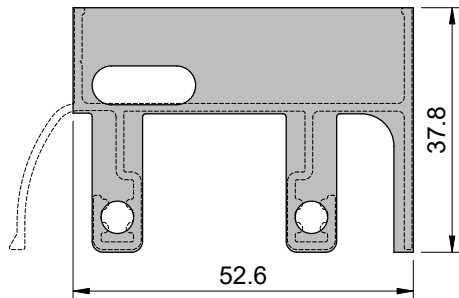

JTV-22002	Junta de vedação
	aplicação perfil RE-22002

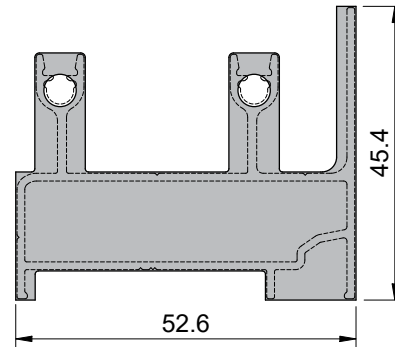

JTV-22005	Junta de vedação
	aplicação perfil RE-22005

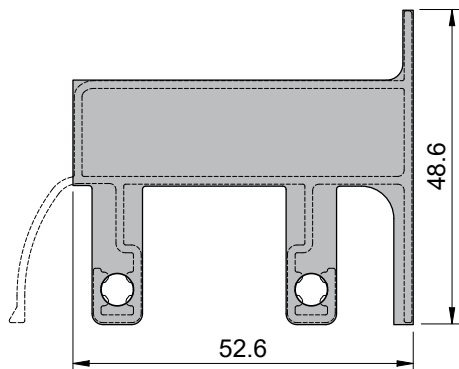

JTV-22006	Junta de vedação
	aplicação perfil RE-22006

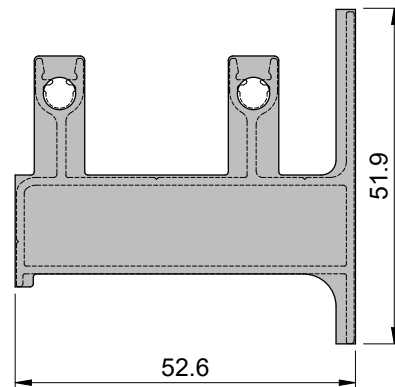

JTV-22101	Junta de vedação
	aplicação perfil RE-22101

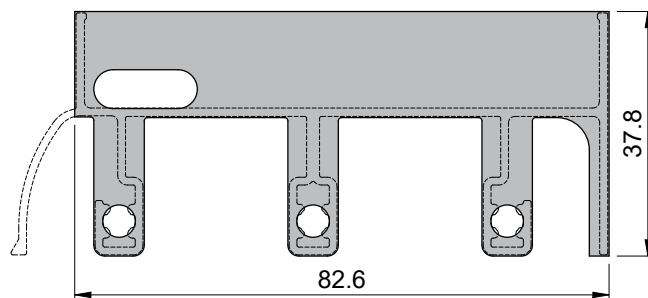

JTV-22102	Junta de vedação
	aplicação perfil RE-22102

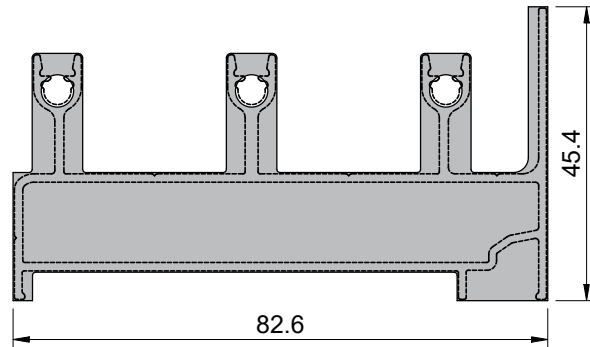

JTV-22105	Junta de vedação
	aplicação perfil RE-22105

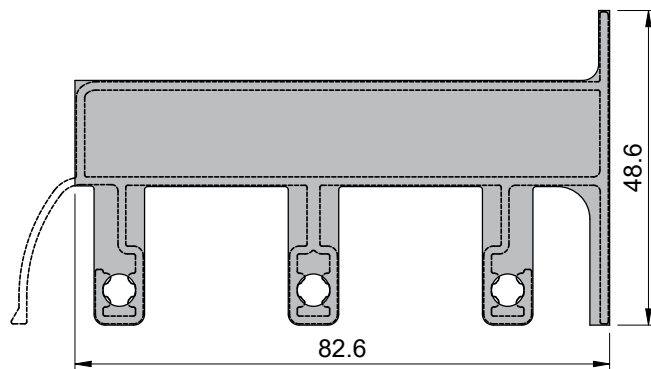

JTV-22106	Junta de vedação
	aplicação perfil RE-22106

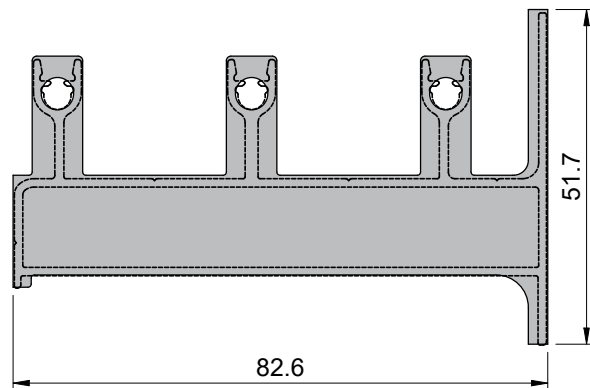

JTV-22008	Junta de vedação
	aplicação perfil RE-22008

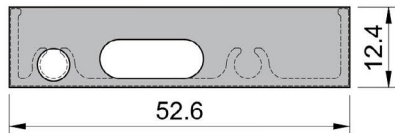

JTV-22108	Junta de vedação
	aplicação perfil RE-22108

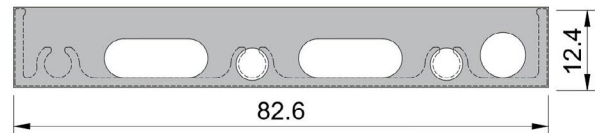

JTV-22201	Junta de vedação
	aplicação perfil RE-22201

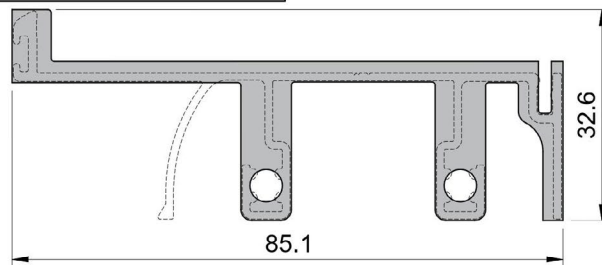

JTV-0025	Junta de vedação
	aplicação perfil ALG-1001

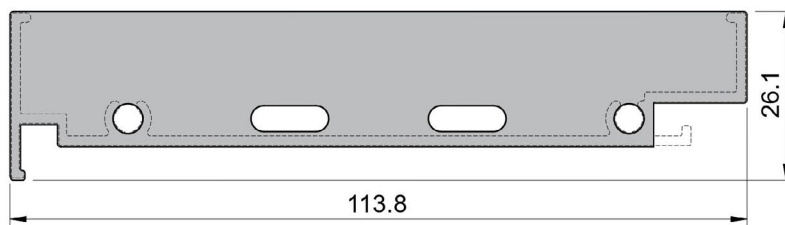

JTV-3415	Junta de vedação
	aplicação perfil CX-3415

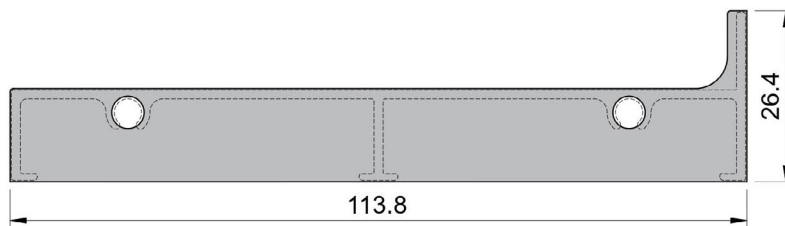

JTV-0026	Junta de vedação
	aplicação perfil ALG-1001

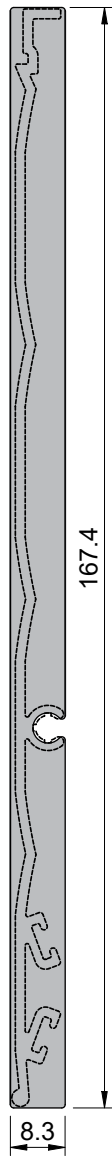

JTV-0027	Junta de vedação
	aplicação perfil ALG-1010

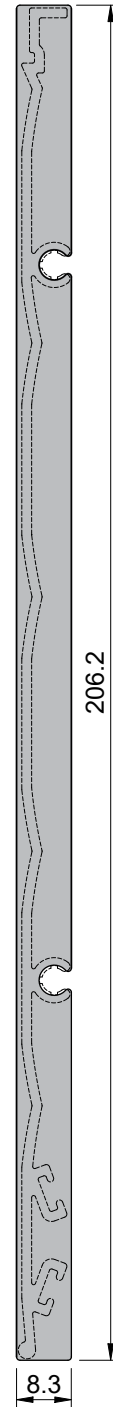

TMT-0001	Tampa montante
	Polimero cor: preto / branco

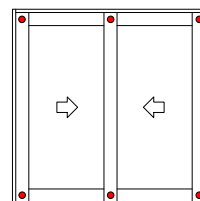
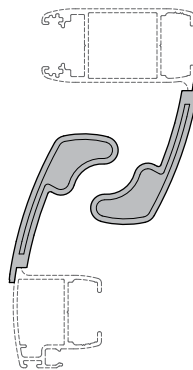
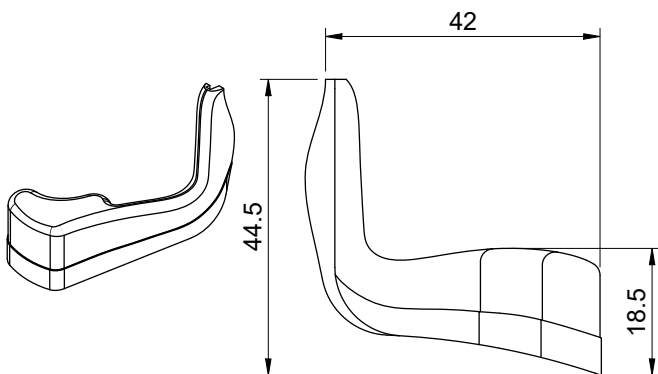

TMT-0002	Tampa montante
	Polimero cor: preto / branco

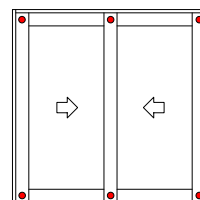
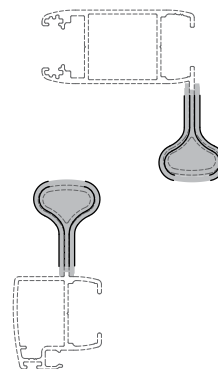
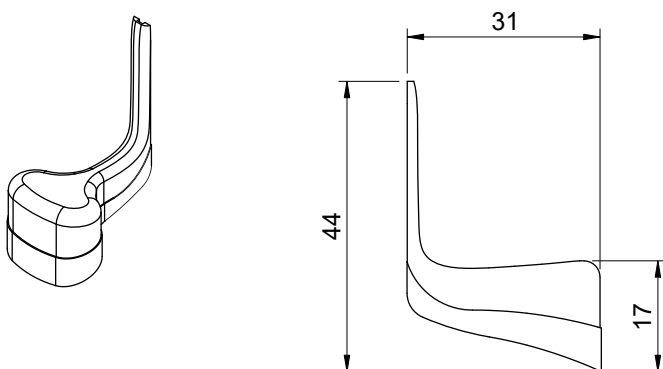

TMT-0021	Tampa montante
	Polimero cor: preto / branco

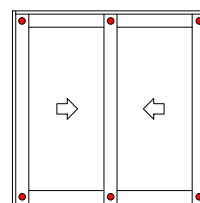
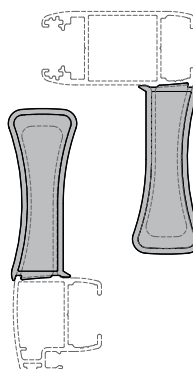
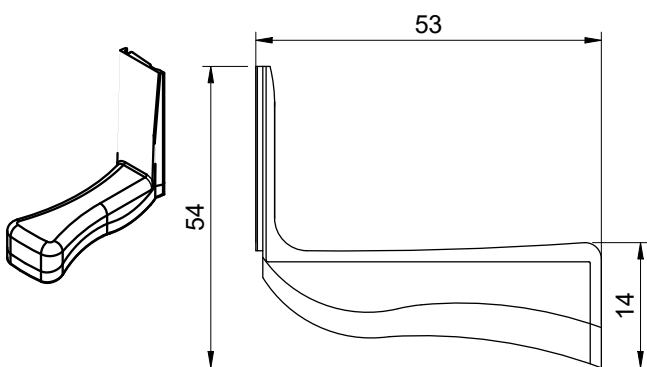

GDE-22001	Guia deslizante mão de amigo
	Polimero cor: preto / branco

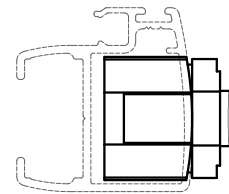
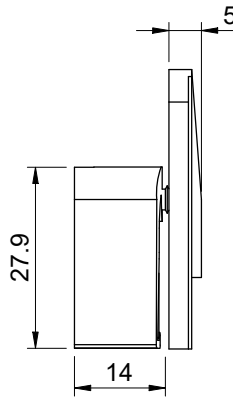
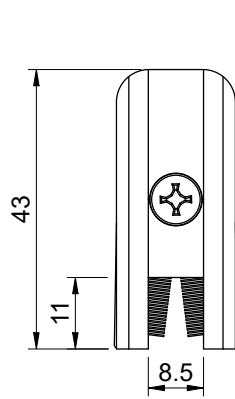
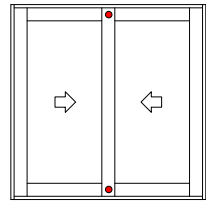
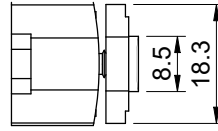
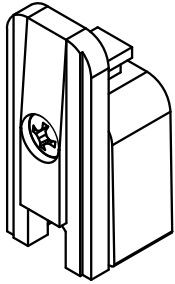

ESCALA 1:1

GDE-22002	Guia deslizante lateral
	Polimero cor: preto / branco

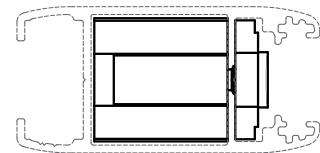
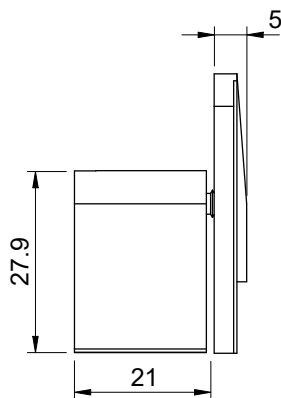
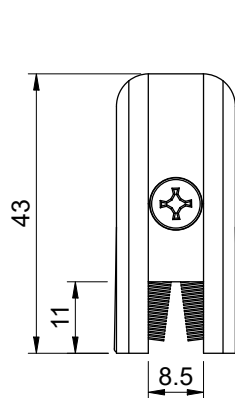
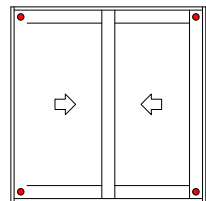
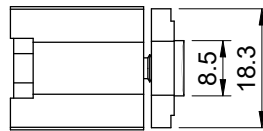
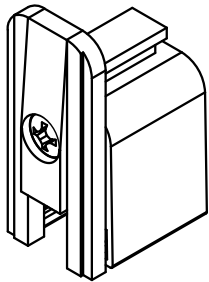

ESCALA 1:1

BTE-0001	Batedeira
	Polimero cor: preto / branco

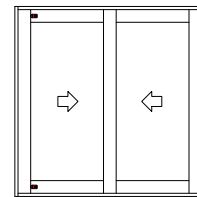
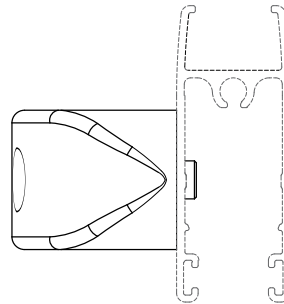
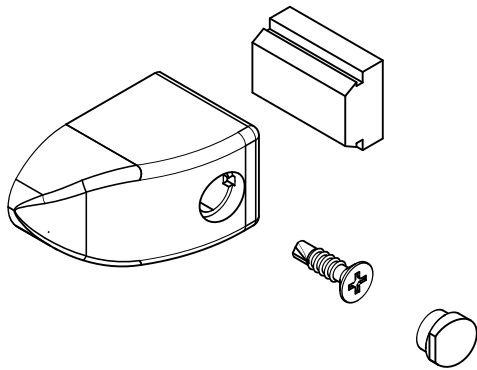

BTE-0007	Batedeira
	Polimero cor: preto / branco

*Atenção ao recorte no trilho RE-22901 para aplicação da batedeira

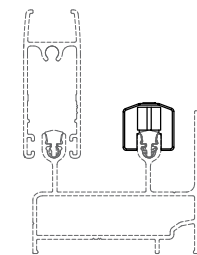
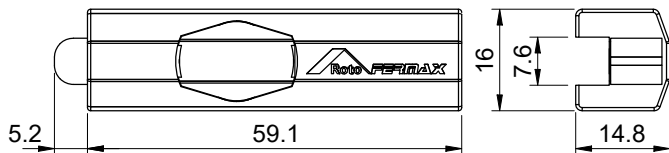
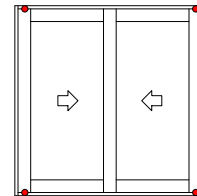
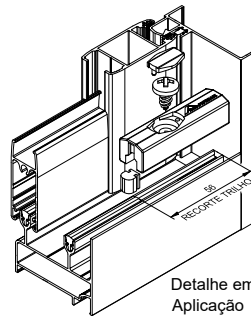
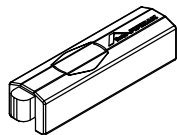

*Usinagem consultar ficha técnica do Fornecedor

BTE-0008	Batedeira de trilho
	Polimero cor: preto / branco

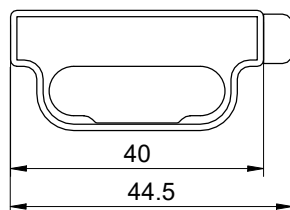
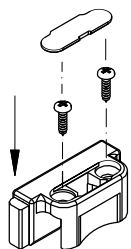

ESCALA 1:1

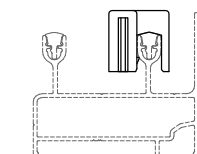
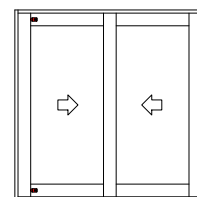
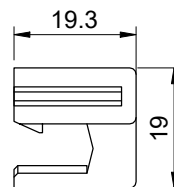

PRT-0002	Presilha do arremate
	Polimero cor: preto

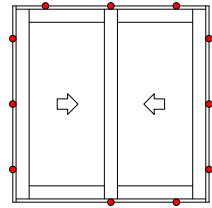
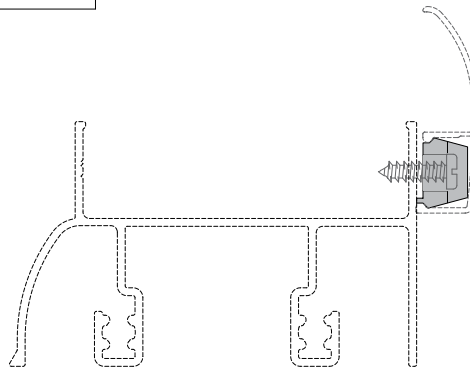
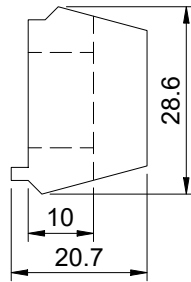
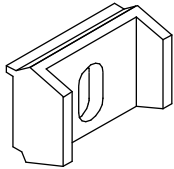

TMT-0004	Botão tampa furo
	Polimero cor: preto / branco

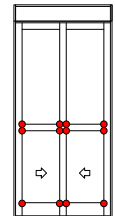
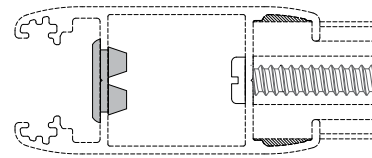
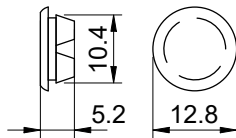

VDA-22002	Vedação Sup/Inf
	Aluminio cor: preto / branco

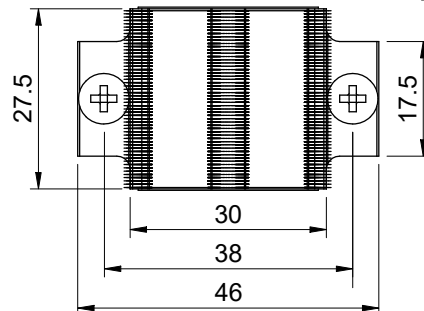
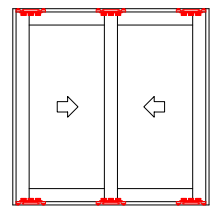
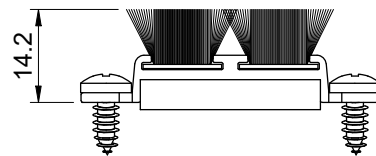
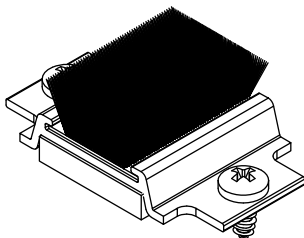

VDA-22001	Vedação Sup/Inf
	Polímero cor: preto / branco

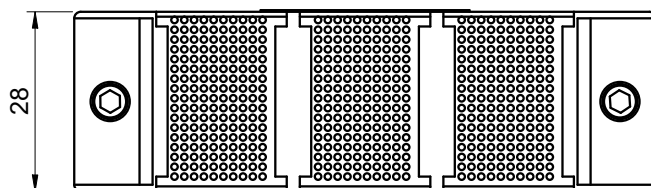
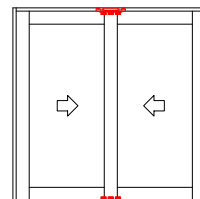
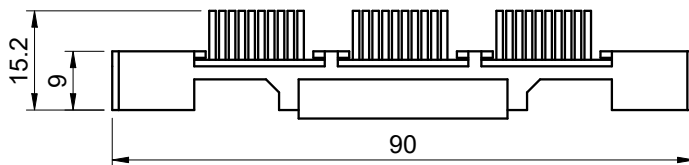
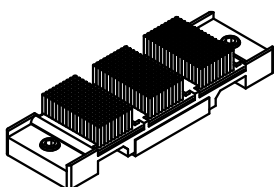

VDA-22011	Vedação Sup/Inf de Canto
	Polímero cor: preto / branco

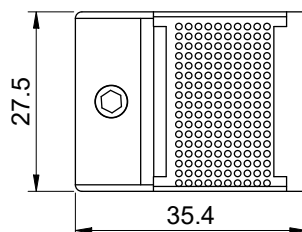
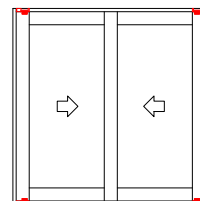
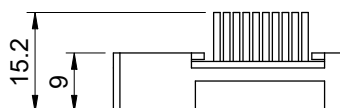
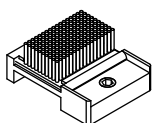

VDA-22003	Vedação Sup/Inf
	Polímero cor: preto / branco

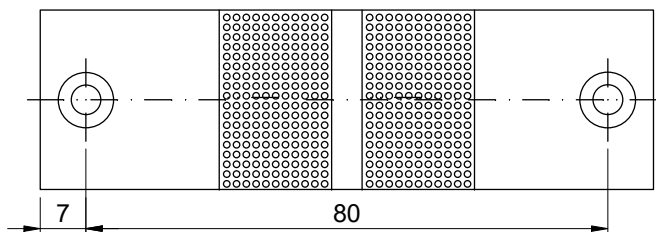
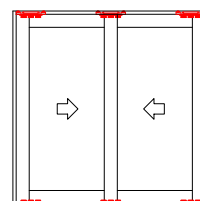
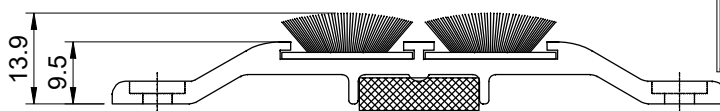
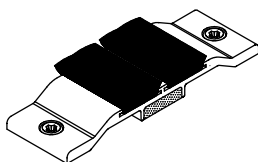

DRN-22001	Dreno flap saída d'água
	Polimero cor: preto / branco

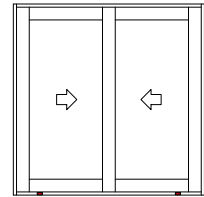
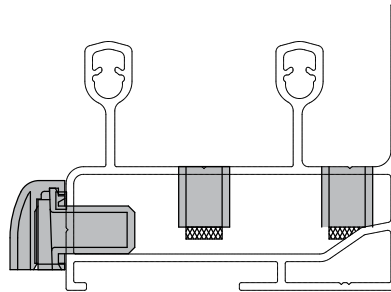
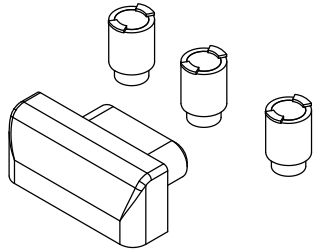

*Aplicação conforme usinagem do fornecedor

DRN-22002	Dreno flap
	Polimero cor: preto / branco

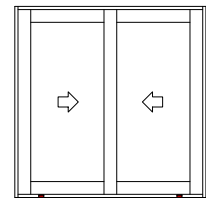
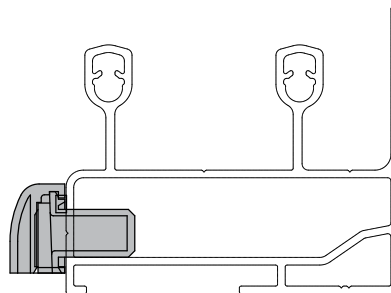
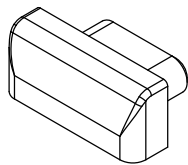

*Aplicação conforme usinagem do fornecedor

DRN-22012	Saída d'água
	Polimero cor: preto / branco

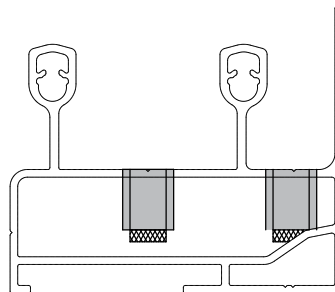
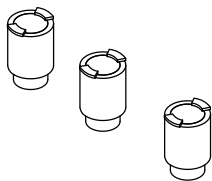

*Aplicação conforme usinagem do fornecedor

CAL-0001	Calço da folha fixa
	Polimero cor: preto

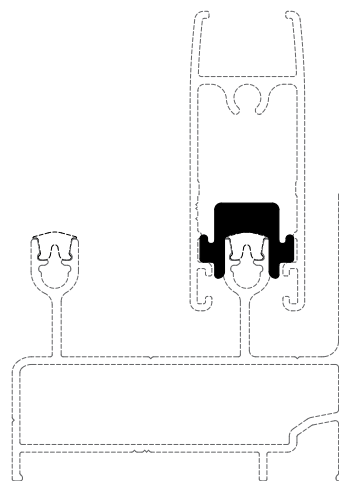
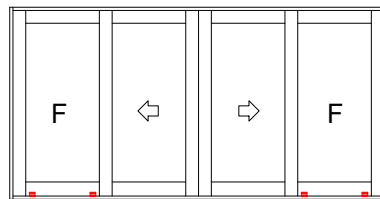
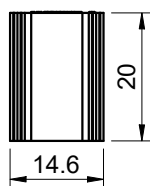
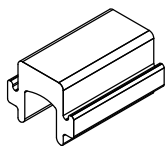

TRV-22003	Trava da folha fixa
	Polimero cor: preto

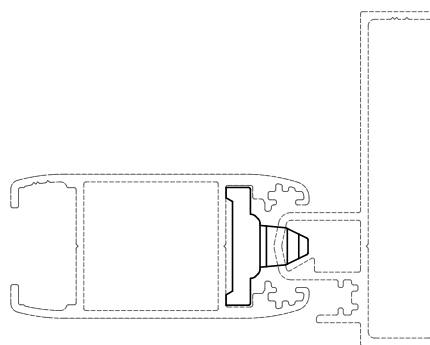
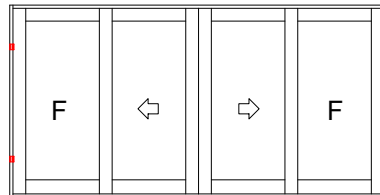
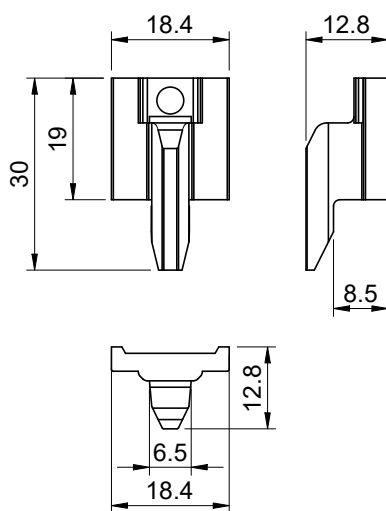
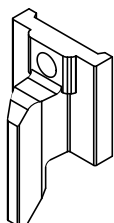

ESCALA 1:1

CHC-0001	Concha cega janela fix. Ap
	Aluminio / Polimero

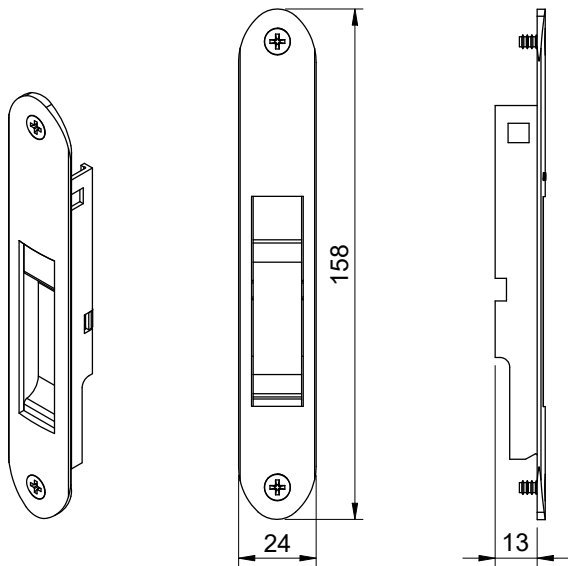

CHC-0002	Concha cega porta fix. Ap
	Aluminio / Polimero

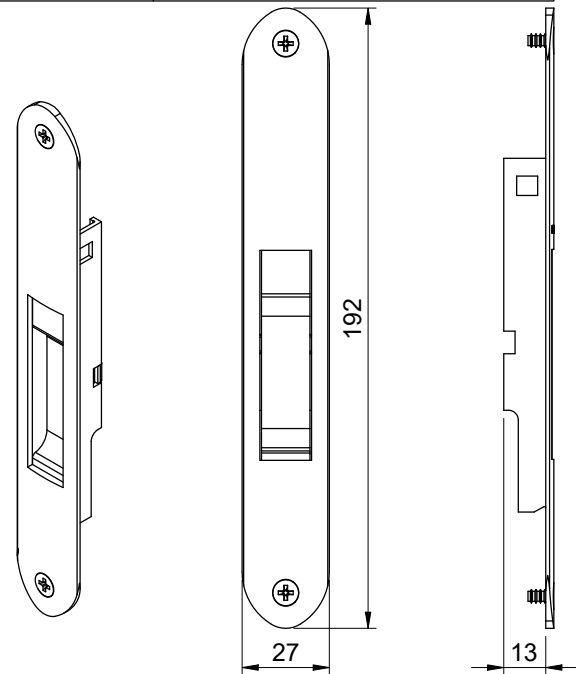

CHC-0003	Concha cega janela
	Aluminio / Polimero

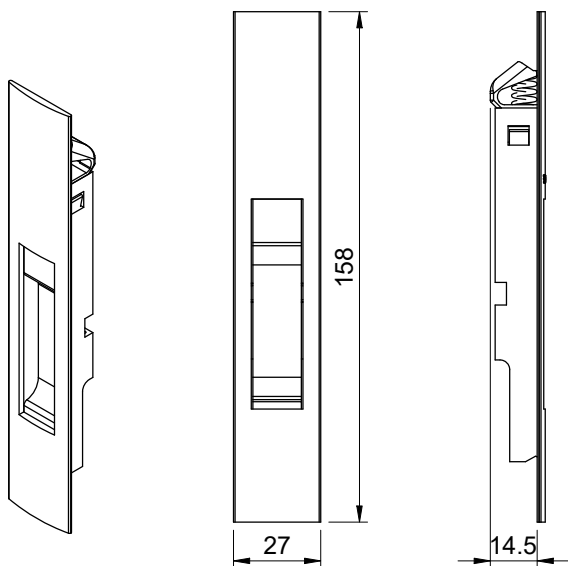

CHC-0004	Concha cega porta
	Aluminio / Polimero

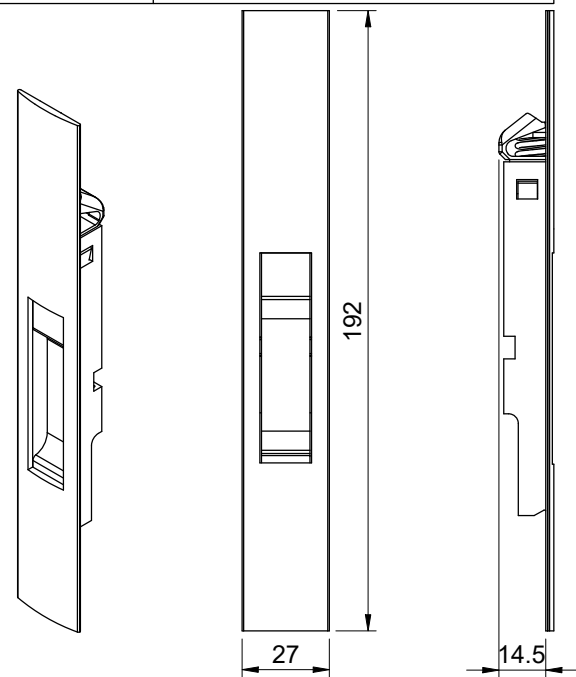

Usinagem	Concha cega
	Estampo/Pantografo

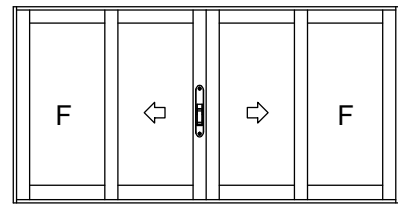
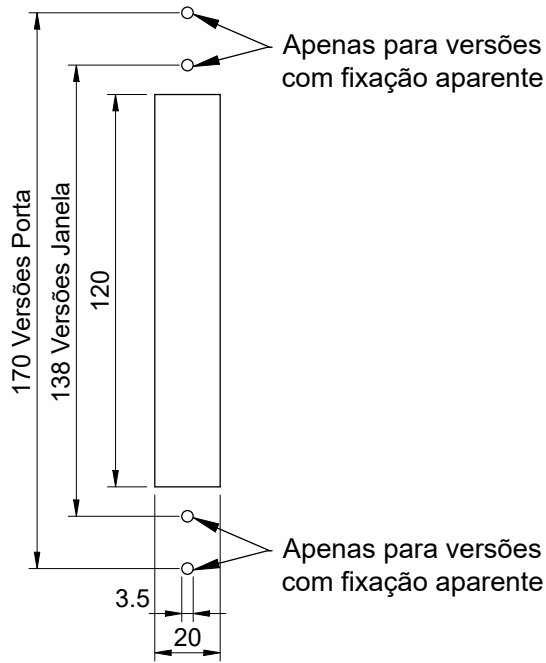

*OBSERVAÇÃO: Consultar catálogos dos fornecedores para validação das usinagens e verificação de outras opções de produtos.

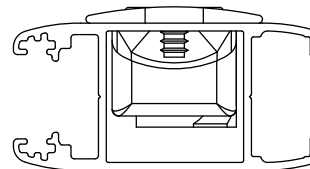

FCH-0001	Fecho janela com chave fix. Ap
	Aluminio / Polimero

FCH-0002	Fecho janela sem chave fix. Ap
	Aluminio / Polimero

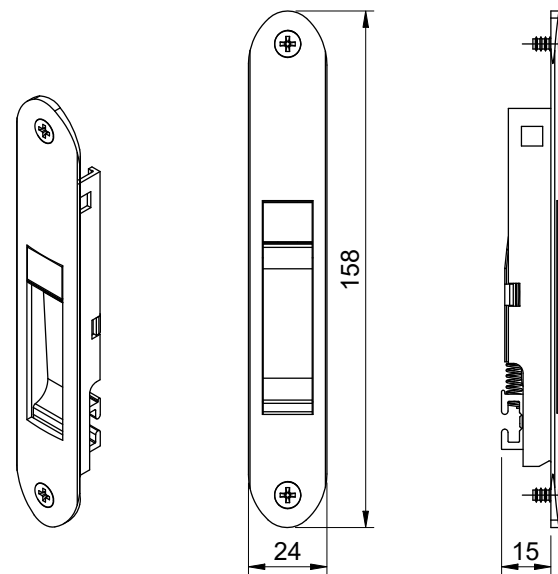
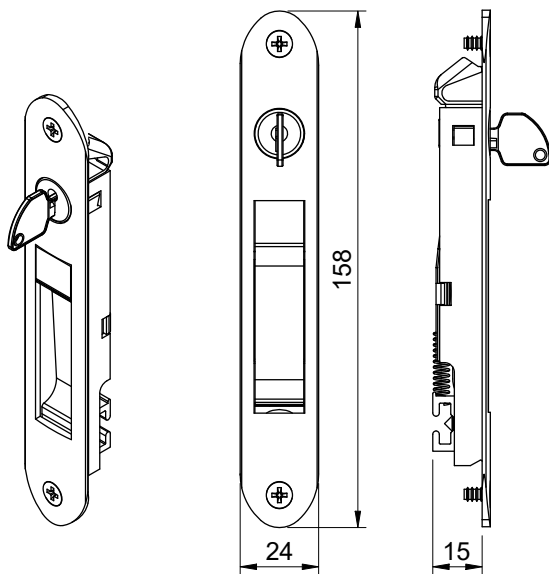

FCH-0003	Fecho porta com chave fix. Ap
	Aluminio / Polimero

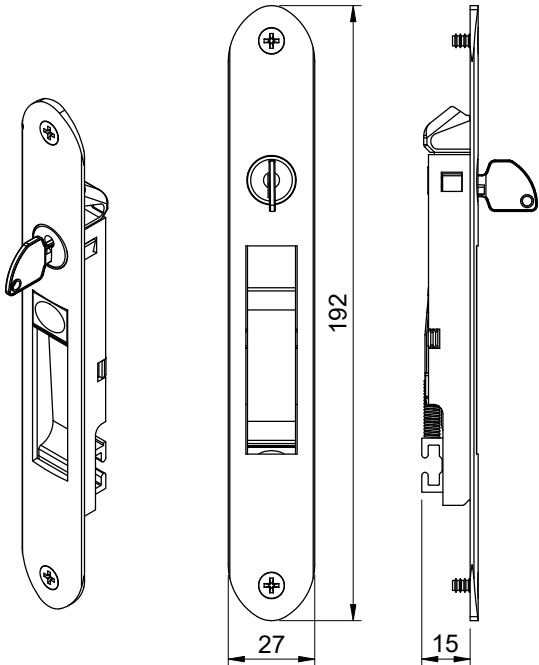

FCH-0004	Fecho porta sem chave fix. Ap
	Aluminio / Polimero

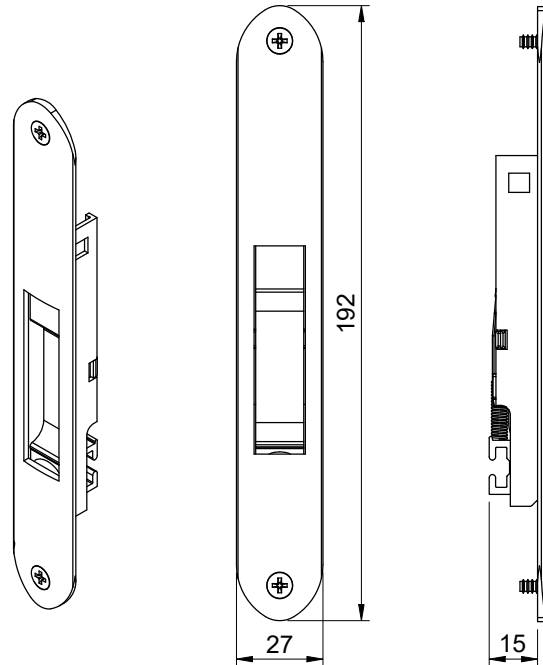

Usinagem	Fecho Concha Tradicional/Slide
	Estampo/Pantografo

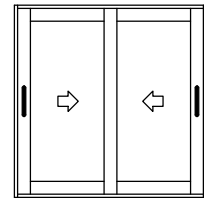
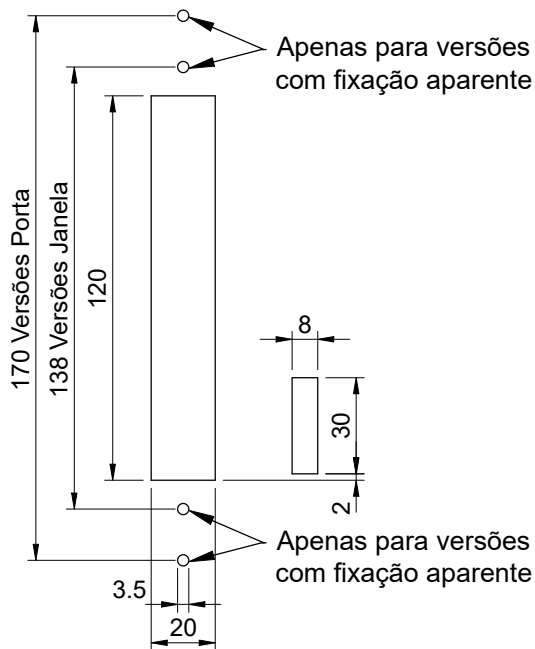

*OBSERVAÇÃO: Consultar catálogos dos fornecedores para validação das usinagens e verificação de outras opções de produtos.

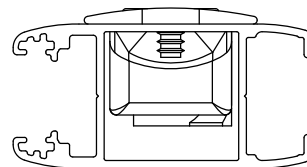

FHC-0005	Fecho janela com chave
	Aluminio / Polimero

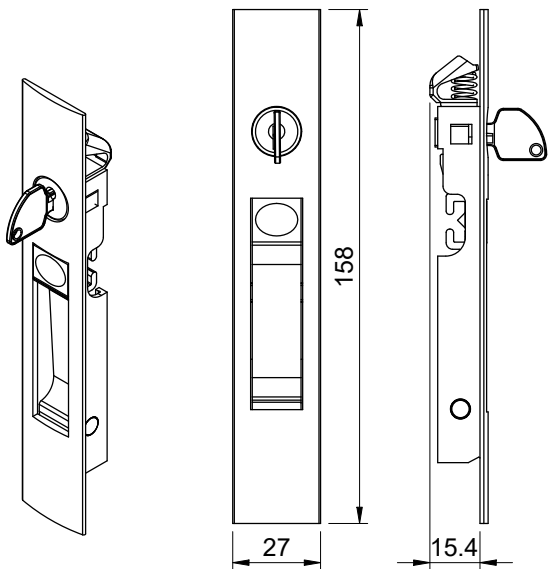

FHC-0006	Fecho janela sem chave
	Aluminio / Polimero

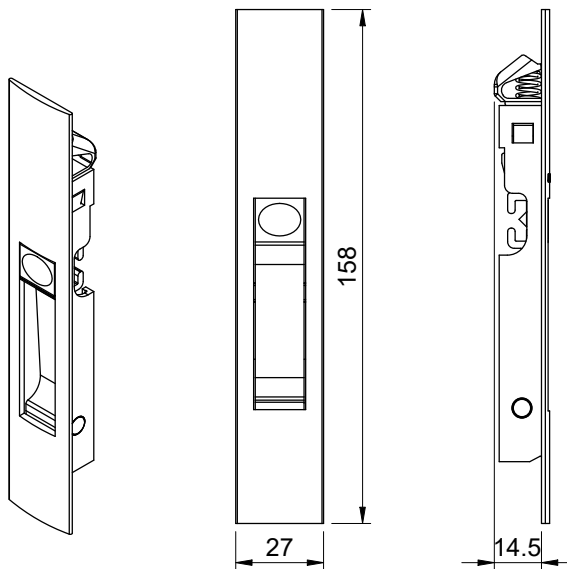

FHC-0026	Fecho porta com chave
	Aluminio / Polimero

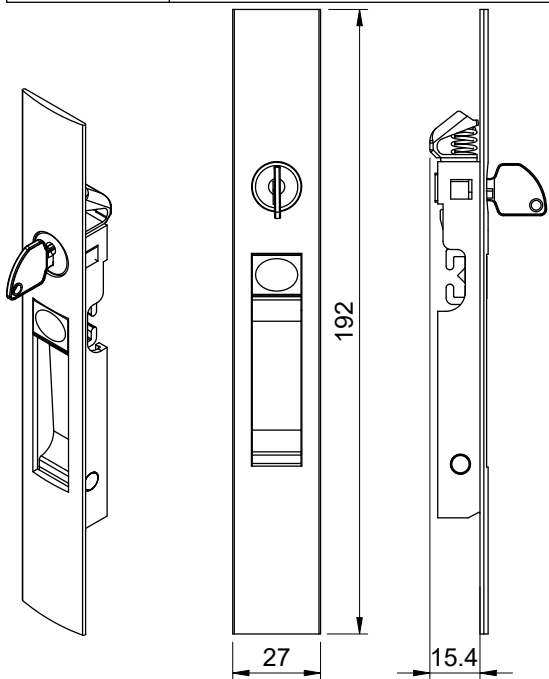

FHC-0027	Fecho porta sem chave
	Aluminio / Polimero

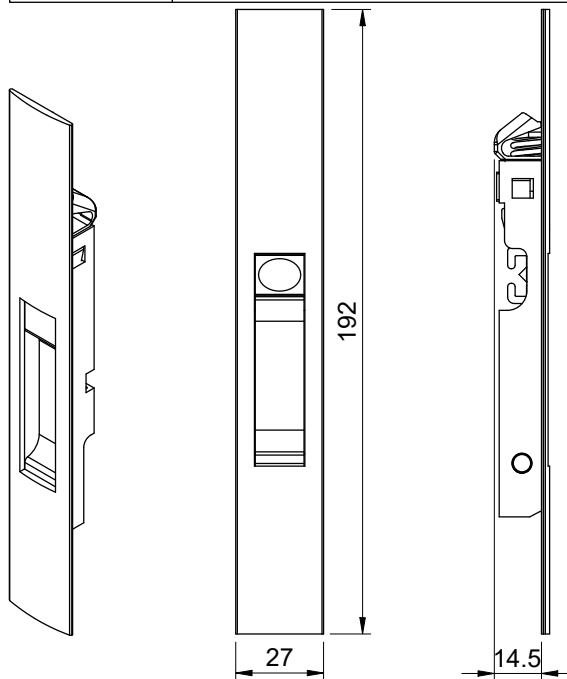

Usinagem	Fecho Concha Toque
	Estampo/Pantografo

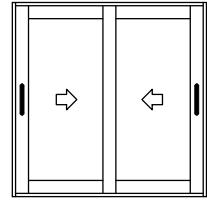
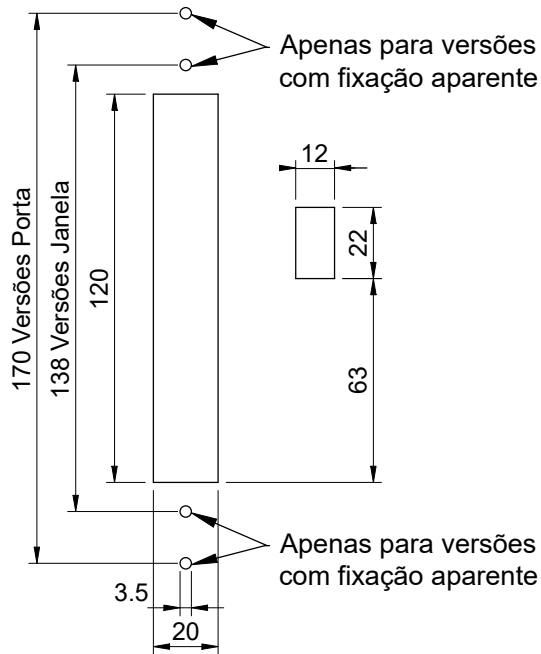

*OBSERVAÇÃO: Consultar catálogos dos fornecedores para validação das usinagens e verificação de outras opções de produtos.

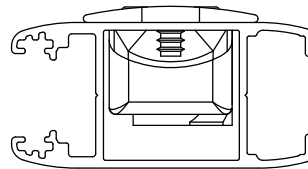

CTF-0001	Contra fecho lateral / central
	Aço inox - Natural

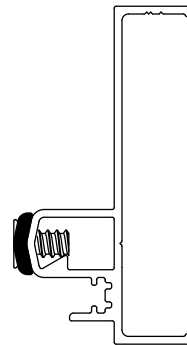
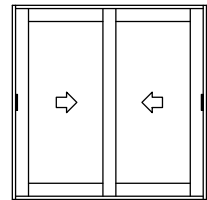
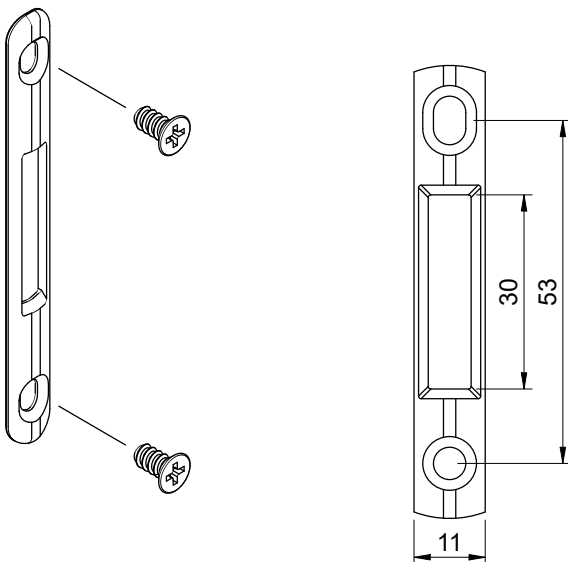

*Usinagem consultar ficha técnica do Fornecedor

TRV-22001	Lingueta da concha
	cor: inox

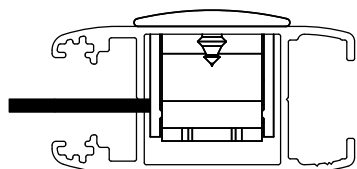
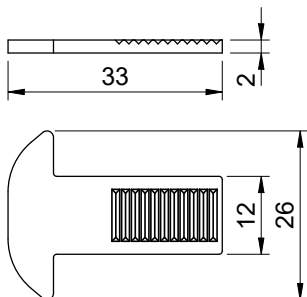

Aplicação

TRV-22002	Lingueta da concha touch
	cor: natural

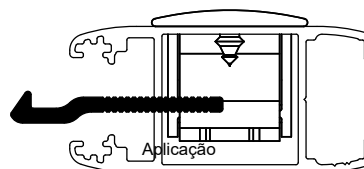
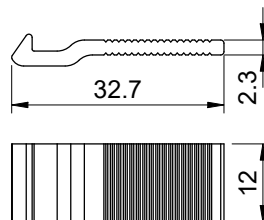

VDA-0011	Lã pet para isolamento acústico
Aplicar em todos os rasgos de conchas para um melhor isolamento acústico	

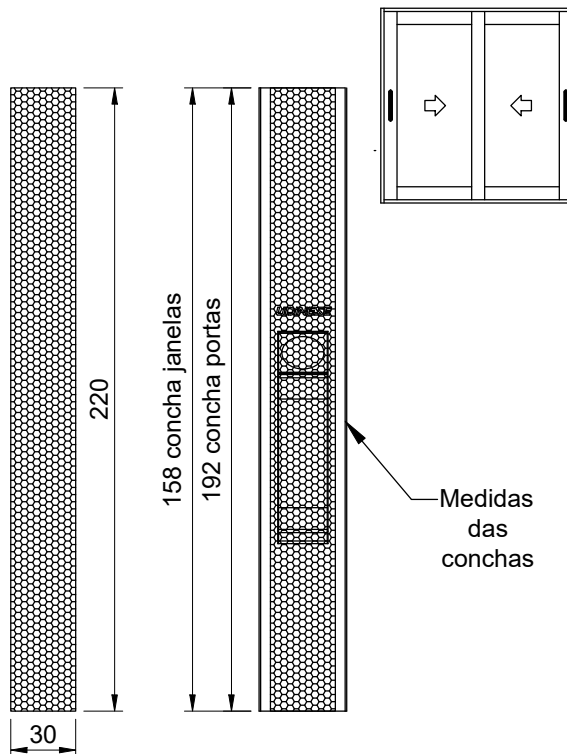

VDA-22005	Espuma de polietileno
-----------	-----------------------

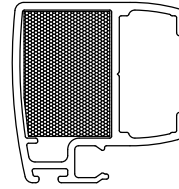
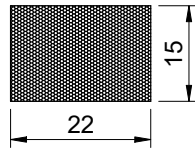
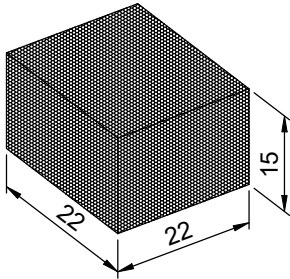

Aplicação

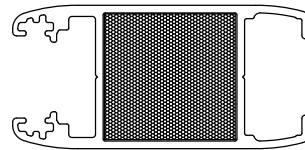
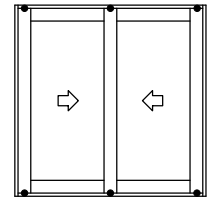

FCH-0038	Fecho cremona para janelas e portas
	cor: preto / branco

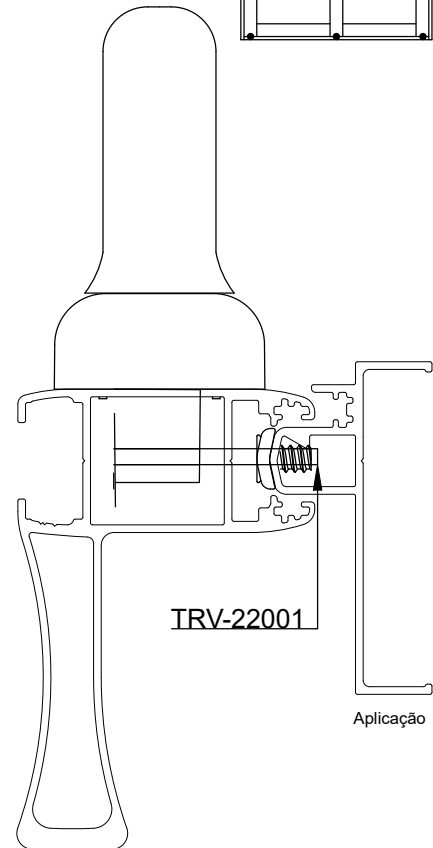
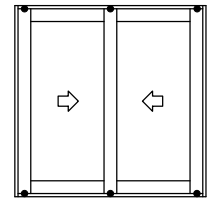
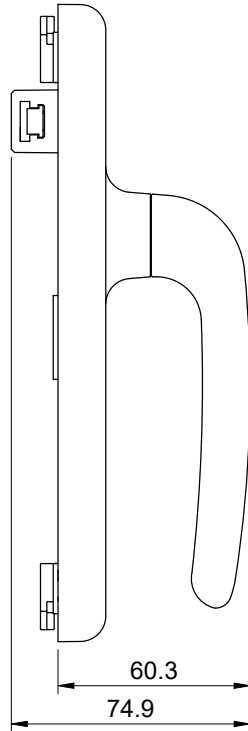
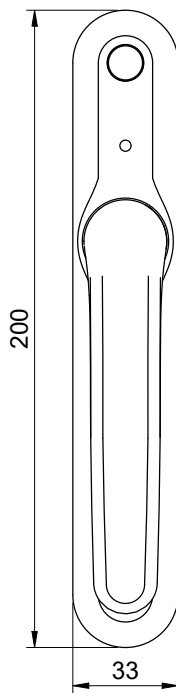
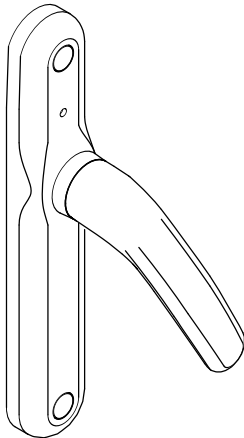

Aplicação

*Usinagem consultar ficha técnica do Fornecedor

CBD-0001	Chumbador de aço zincado
	CM-060 / CM-063 / CM-174

CBD-0002	Chumbador de aço zincado
	CM-060 / CM-063

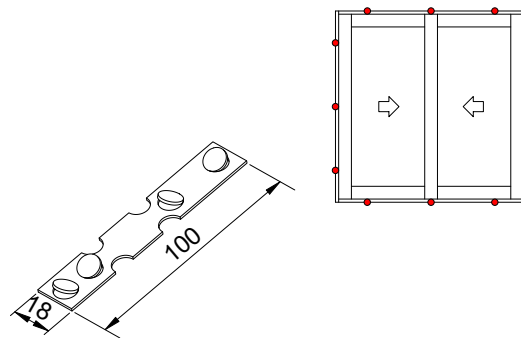
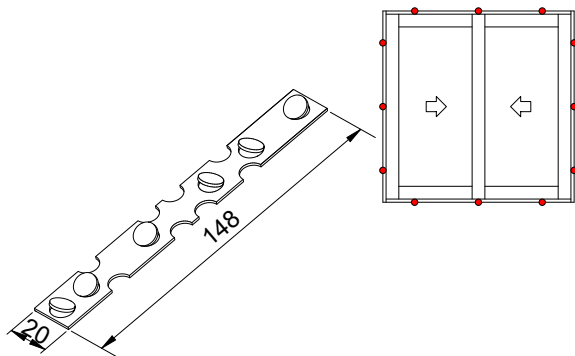

ESP-1118	Espuma de PVC 11x1,8 mm
	vedação do perímetro

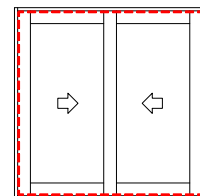
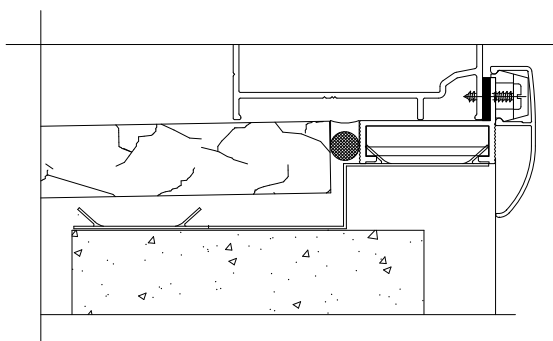
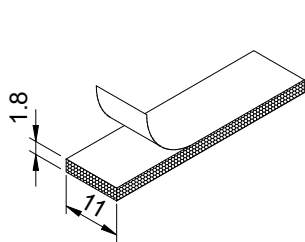

TRL-0001	Trilho de poliamida
	Polimero cor: preto

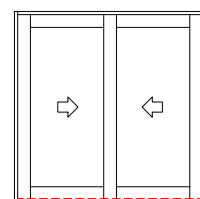
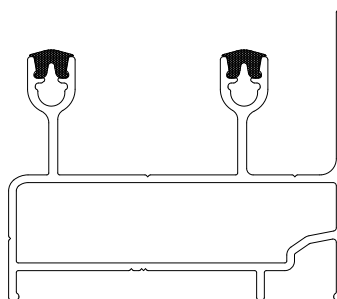
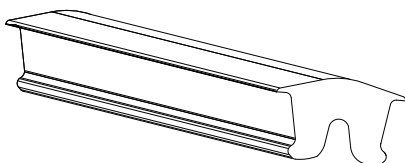
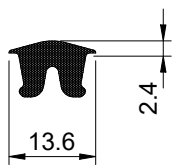

ECV-0001	Escova de vedação 5x6
	cor: preto / branco / cinza

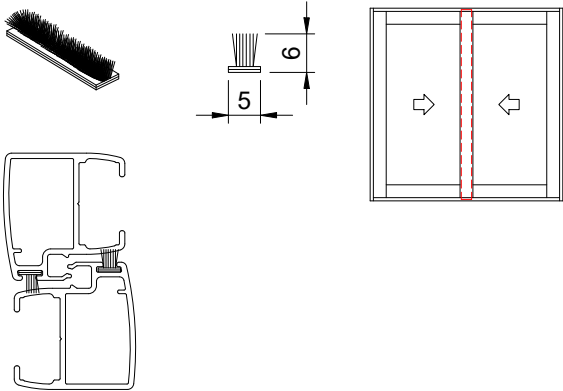

ECV-0001B	Escova de vedação 5x6 com barreira plástica
	cor: preto / branco / cinza

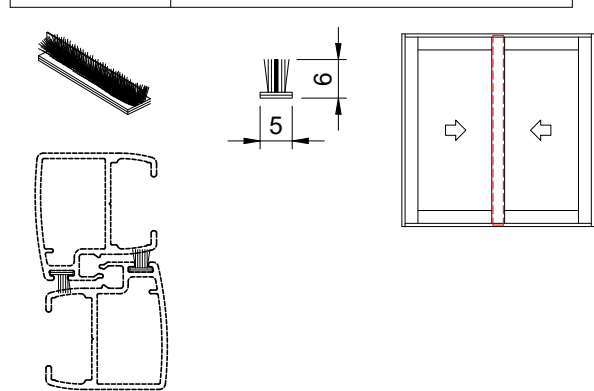

ECV-0010	Escova de vedação 5x4
	cor: preto / branco / cinza

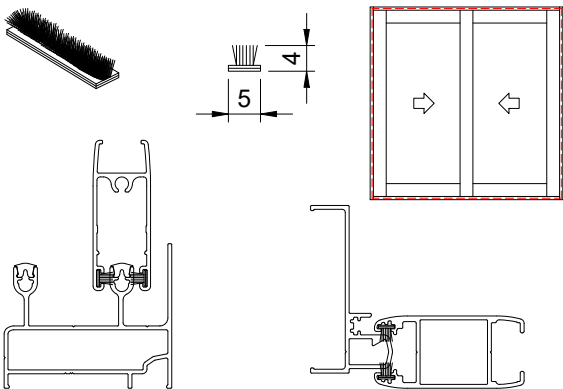

ECV-0010B	Escova de vedação 5x4 com barreira plástica
	cor: preto / branco / cinza

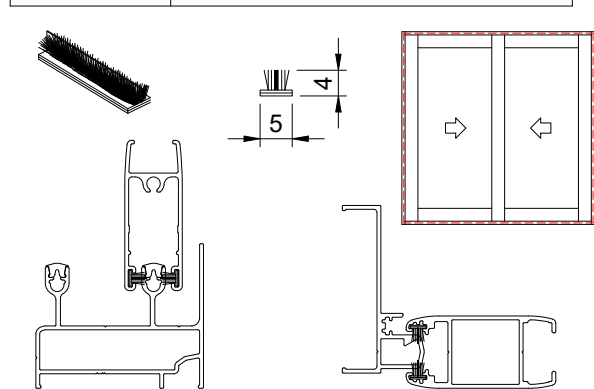

QL-5375	QLON de vedação 5.3x7.5
	cor: preto / branco / cinza

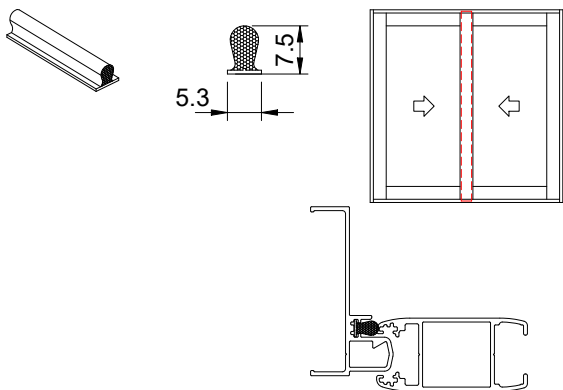

GNC-0001	Guarnição de EPDM
----------	-------------------

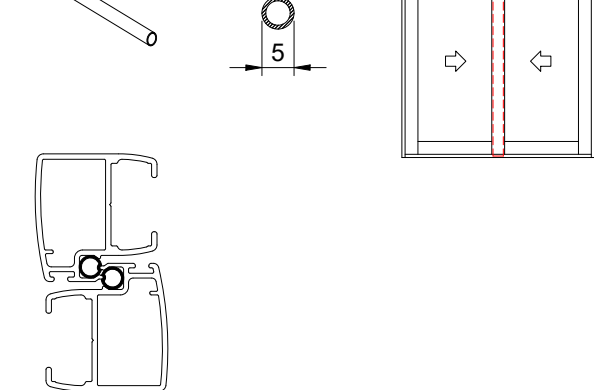

GXT-1123	Guarnição de EPDM
	cunha para vidro de 4mm

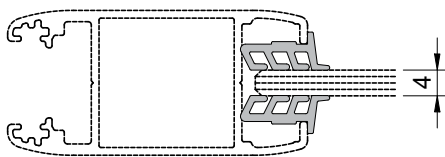
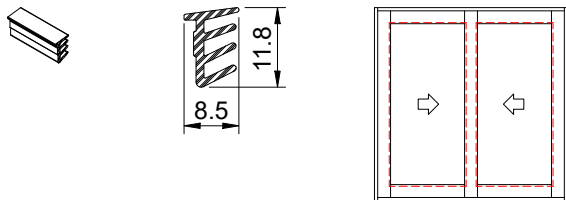

GXT-1124	Guarnição de EPDM
	cunha para vidro de 6mm

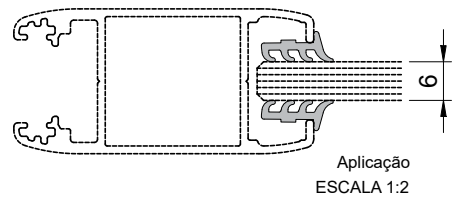
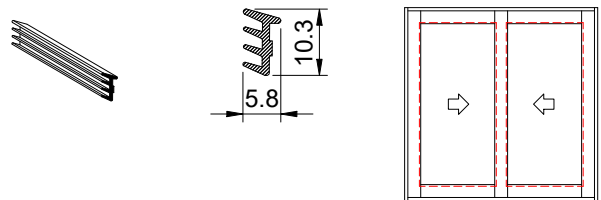

ESP-1103	Espuma de PVC 11x3 mm
	vedação do perímetro externo

Espuma para vidro 6 ou 10mm

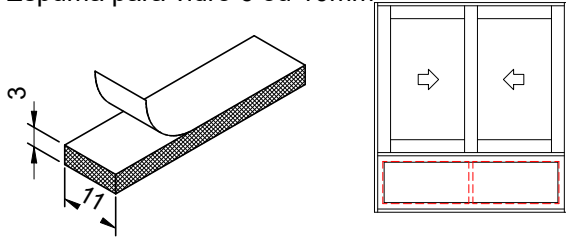

ESP-1106	Espuma de PVC 11x6 mm
	vedação do perímetro externo

Espuma para vidro 4 ou 8 mm

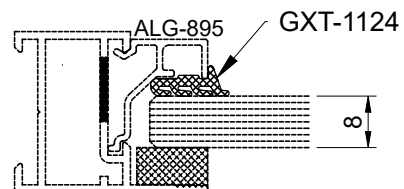
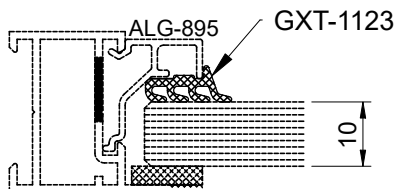
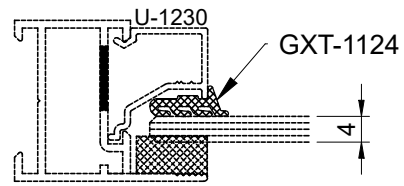
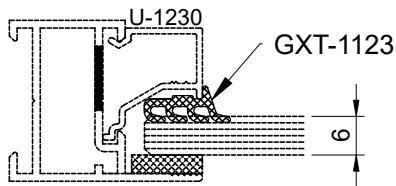
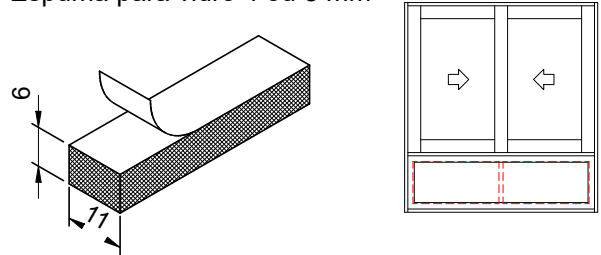

GXT-1157	Guarnição de EPDM
	Cunha Para Vidro de 8mm

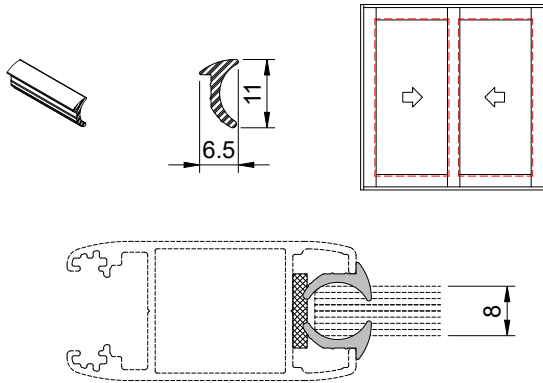

ESP-1406	Espuma de PVC 14x6 mm
	Vedação Perímetro

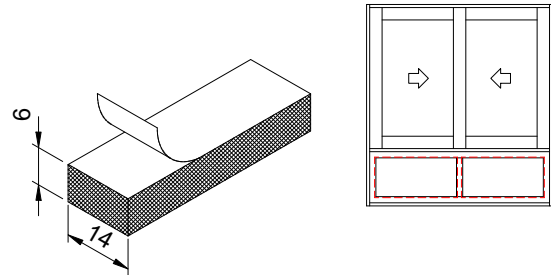

GXT-1127	Guarnição de EPDM
	Vidro de 4mm

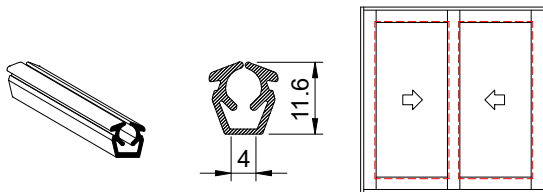

GXT-1128	Guarnição de EPDM
	Vidro de 6mm

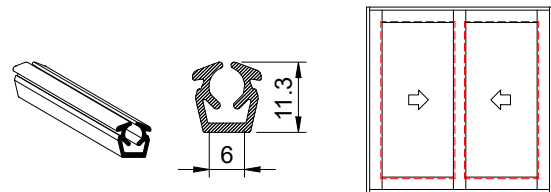

BT-615	Espuma EPDM
	Calço Para Vidro Janela

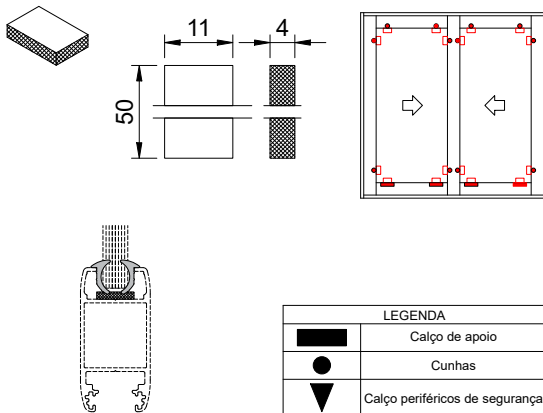

P020010	Espuma EPDM
	Calço Para Vidro Fixo

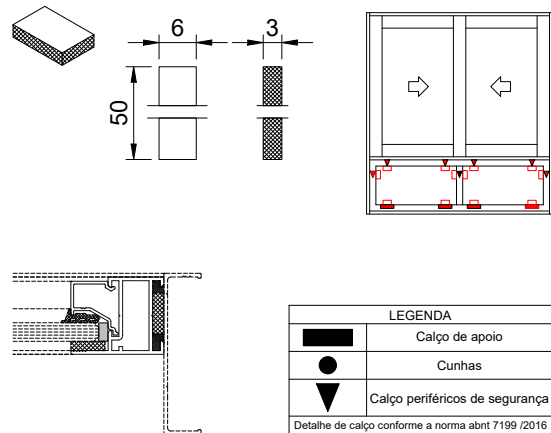

RLD-22111	Roldana simples com rolamento
	Polimero : 15kg por folha (máx)

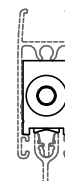
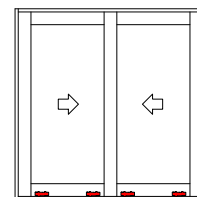
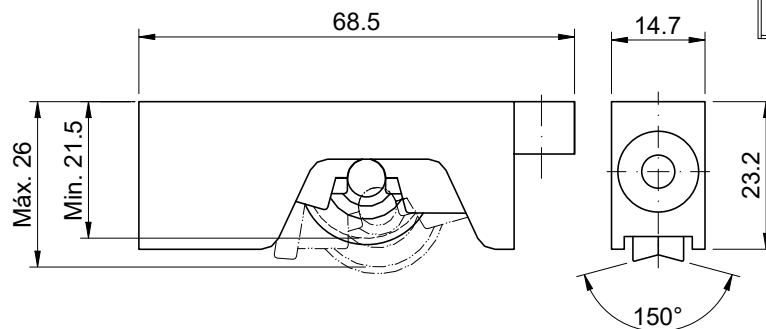
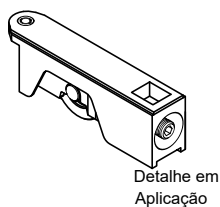

RLD-22001	Roldana simples com rolamento
	Polimero : 30 kg por folha (máx)

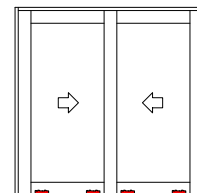
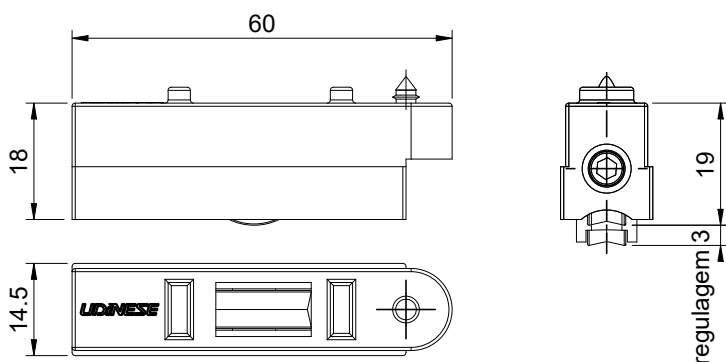

RLD-22011	Roldana simples com rolamento
	Polimero : 40 kg por folha (máx)

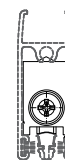
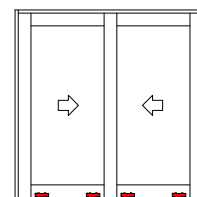
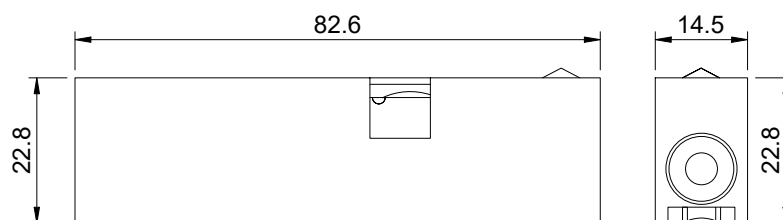
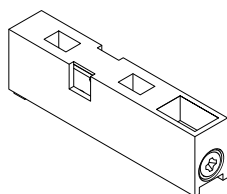

RLD-22112	Roldana dupla com rolamento
	Polimero : 40 kg por folha (máx)

40 kg - 2 roldanas - FISE

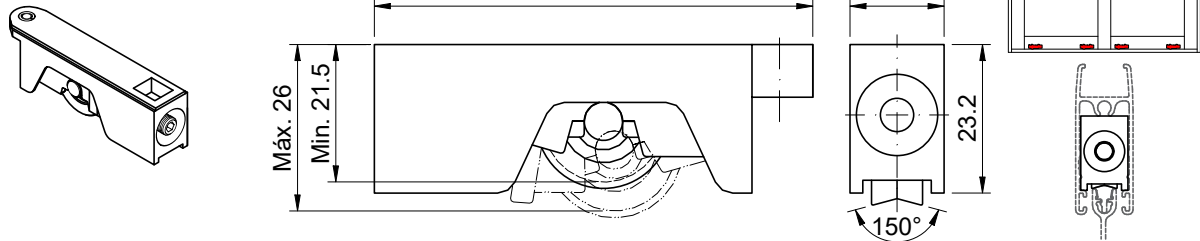

RLD-22002	Roldana dupla com rolamento
	Polimero : 60 kg por folha (máx)

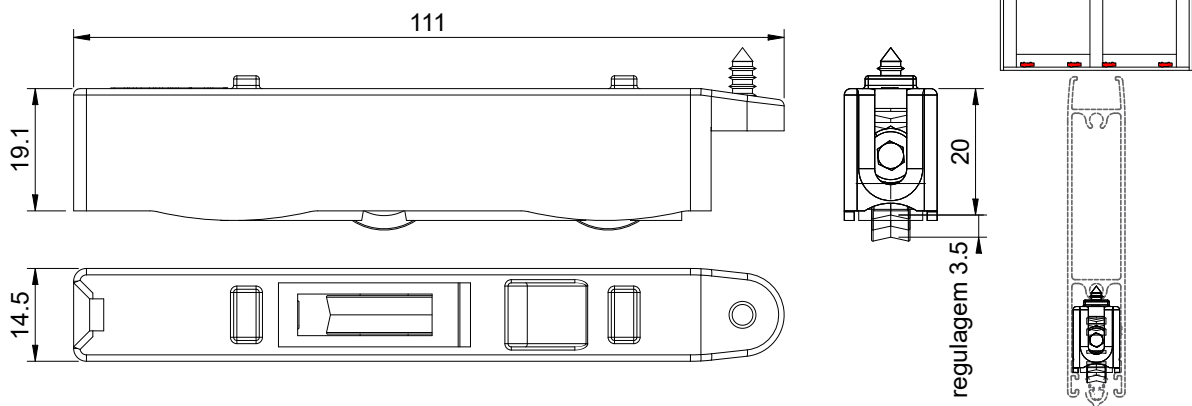

RLD-22012	Roldana dupla com rolamento
	Aluminio : 60 kg por folha (máx)

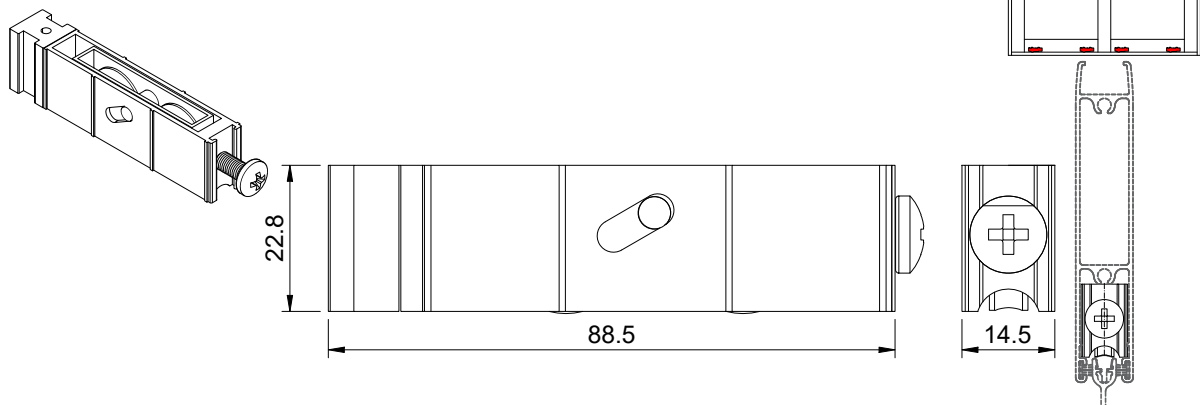

MTA-0001	Manta acústica
	isolamento da caixa da persiana

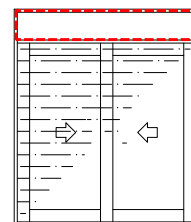
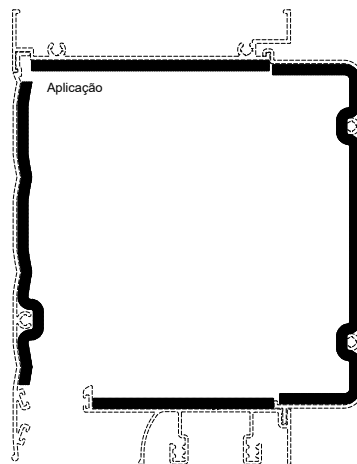

GCT-0003	Guia inferior da cinta
	Polimero cor: preto / branco

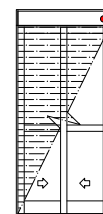
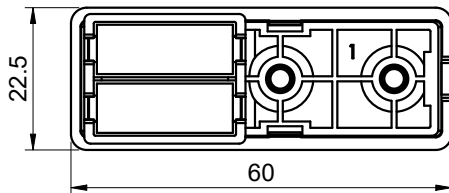
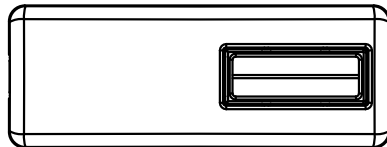
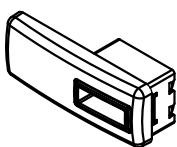

*Usinagem consultar ficha técnica do Fornecedor

GCT-0004	Guia da cinta frontal curva
	Polimero cor: preto / branco

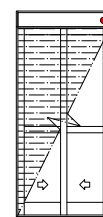
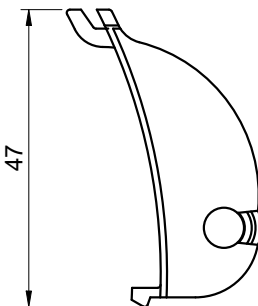
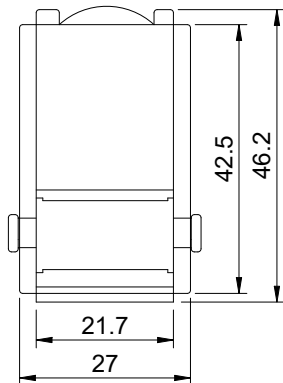

*Usinagem consultar ficha técnica do Fornecedor

GCT-0005	Guia da cinta frontal reta
	Polimero cor: preto / branco

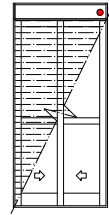
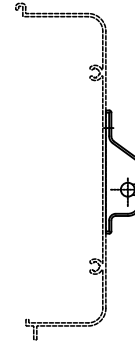
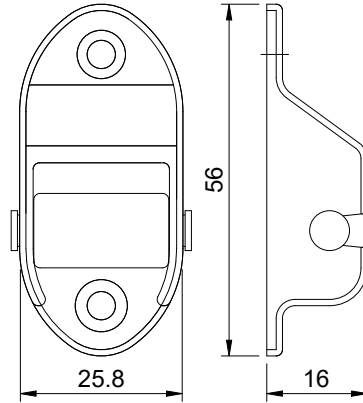

*Usinagem consultar ficha técnica do Fornecedor

GPE-0005	Guia da esteira
	Polimero cor: preto

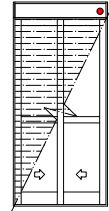
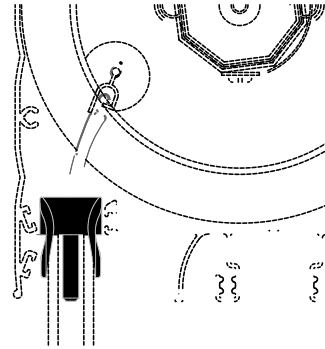
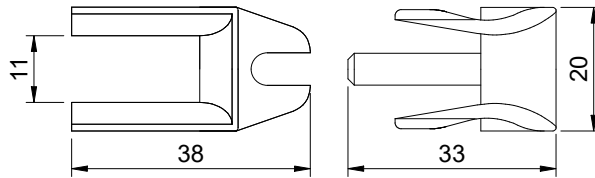
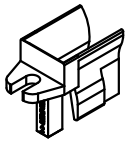

GPE-0006	Guia da esteira
	Polimero cor: preto

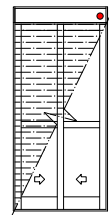
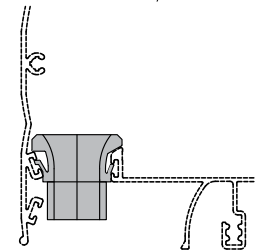
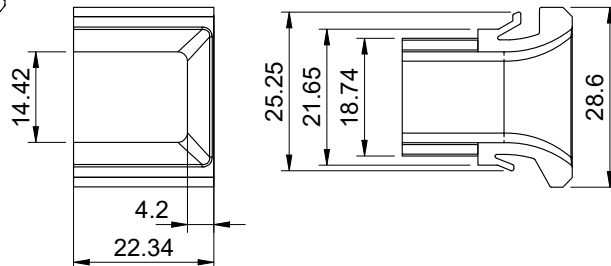
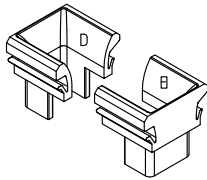

LPE-0001	Limitador da esteira
	Polímero cor: preto / branco

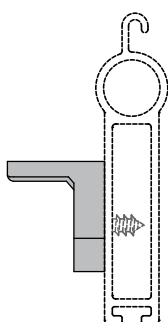
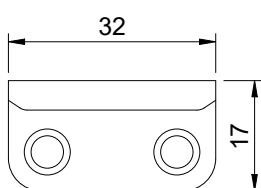
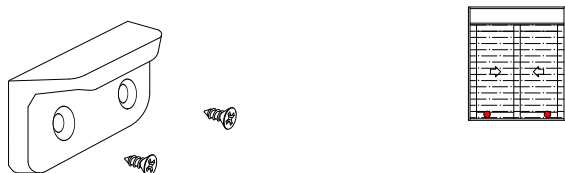

GPE-0002	Guia limitador da esteira
	Polímero cor: preto

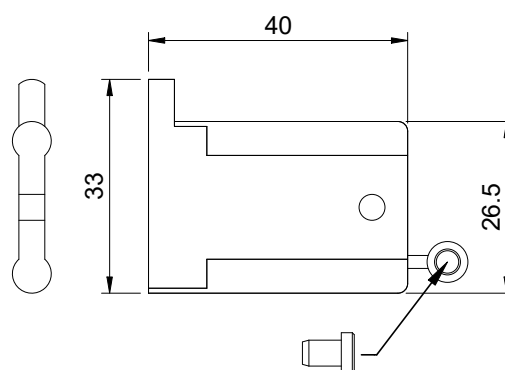
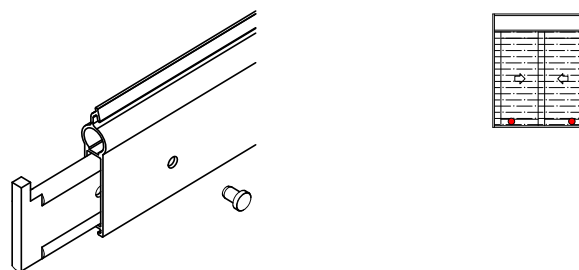

*Usinagem consultar ficha técnica do Fornecedor

Palheta cega	
PAC-0001	Passo de 41mm
PAC-0002	Passo de 43mm
PAC-0003	Passo de 45mm

Palheta ventilada	
PAV-0001	Passo de 41mm
PAV-0002	Passo de 43mm
PAV-0003	Passo de 45mm

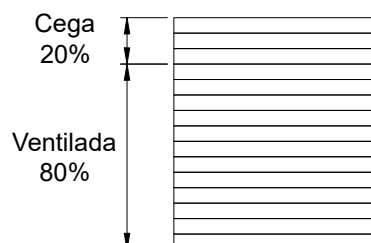
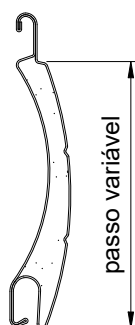

*Largura máxima e peso consultar ficha técnica do Fornecedor

RCO-0001	Recolhedor manual janela
	cor: preto / branco

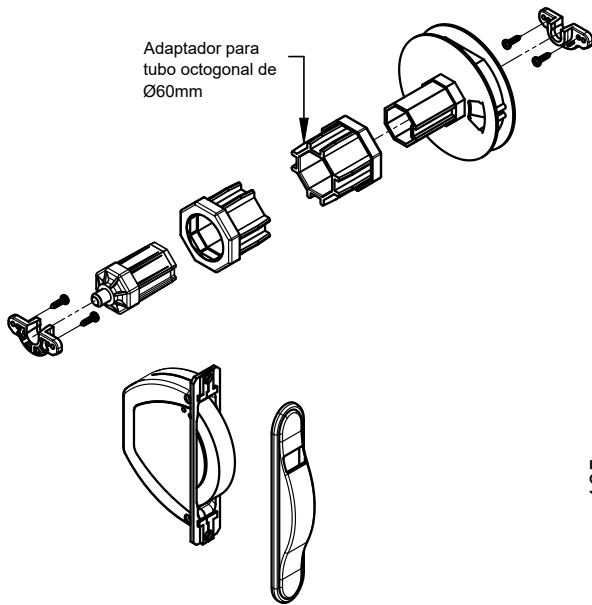
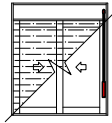

Usinagens

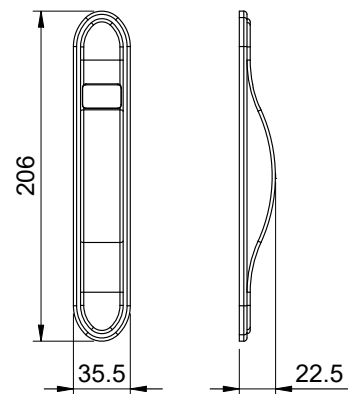
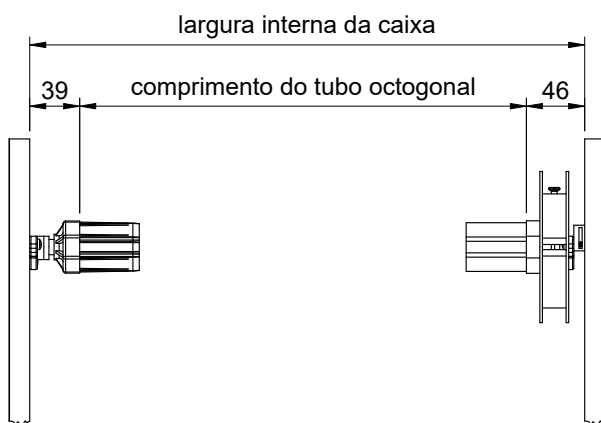
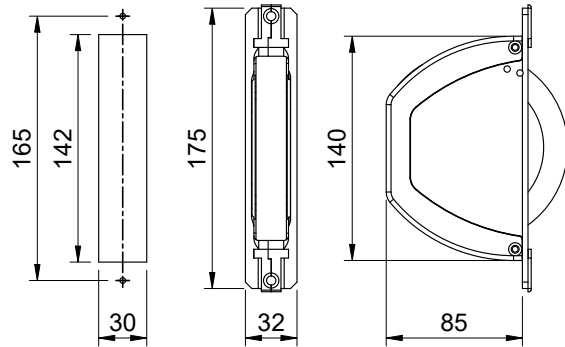

*Usinagem consultar ficha técnica do Fornecedor

RCO-0002	Recolhedor manual porta
	cor: preto / branco

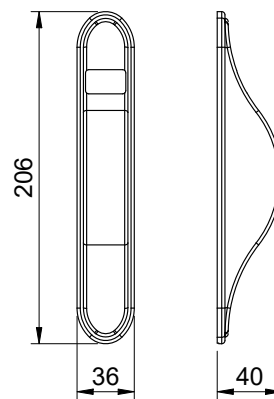
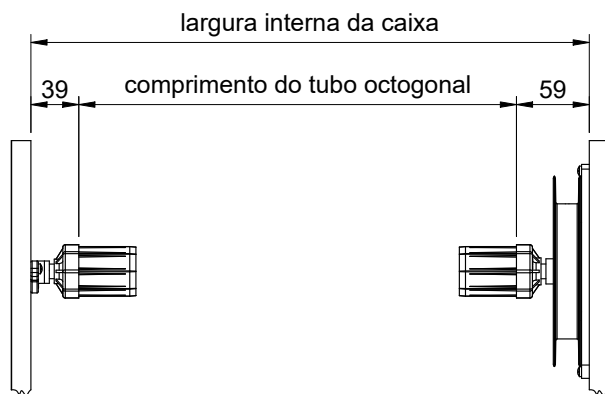
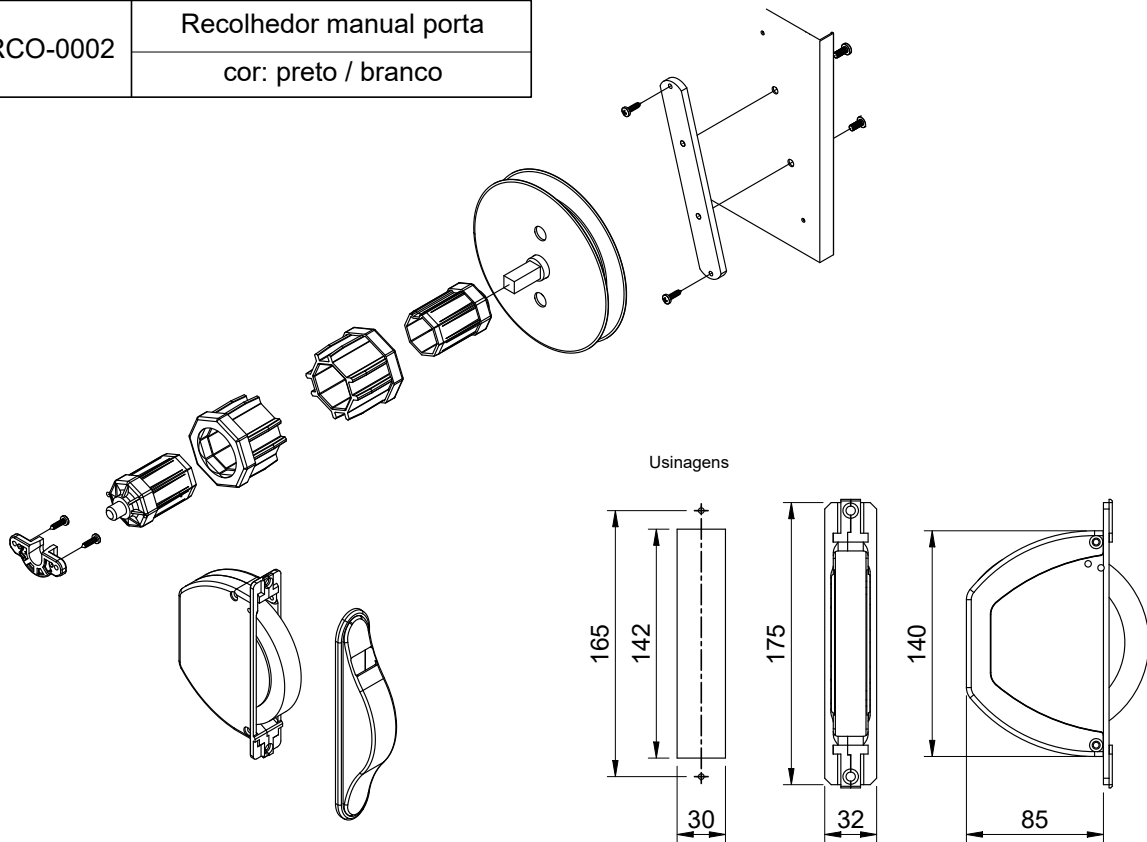

*Usinagem consultar ficha técnica do Fornecedor

Medidas máximas do rolo na caixa da persiana janelas

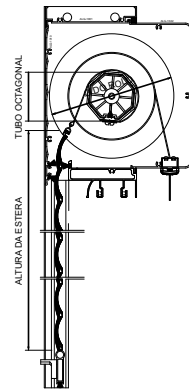
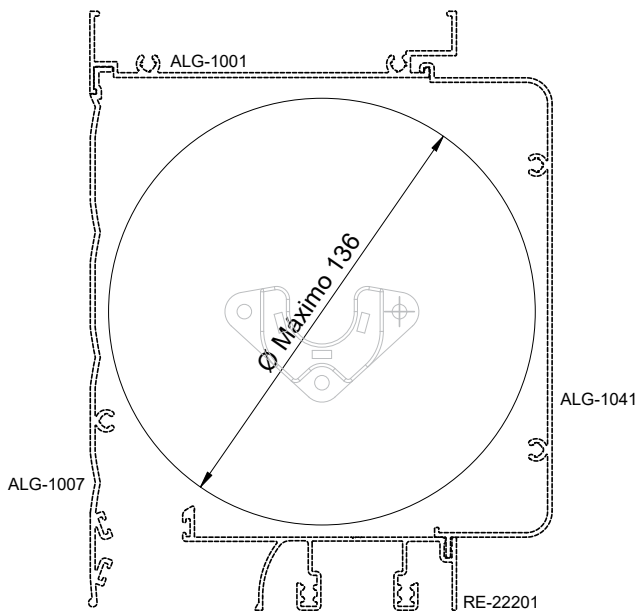
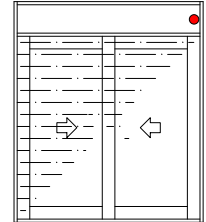
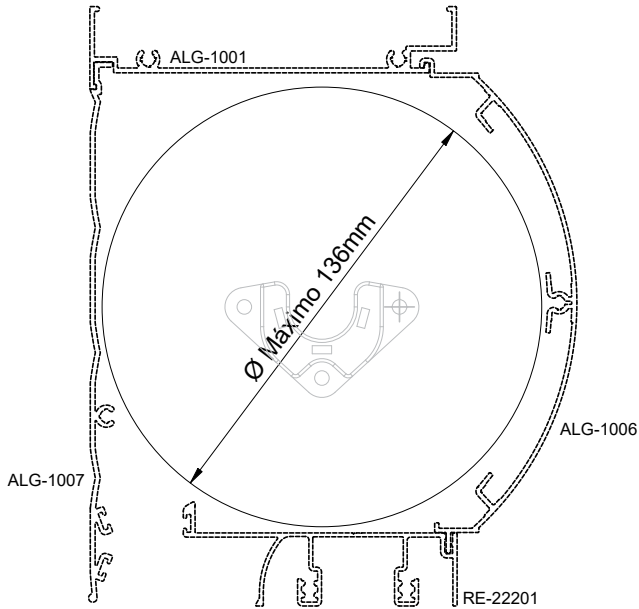

DIMENSÕES DO ROLO DA PERSIANA EM MM		
H = ALTURA TOTAL DO CAIXILHO	DIÂMETRO DO ROLO	
	40	60
1000	120	125
1300	130	135
1600	140	145
1900	150	155
2200	160	165
2500	170	175
2700	175	180
obs.: considerando fita de fixação da esteira, palheta de 41mm		

Medidas máximas do rolo na caixa da persiana portas

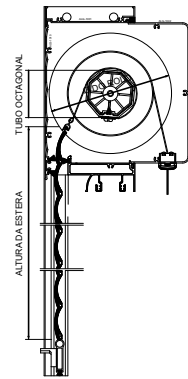
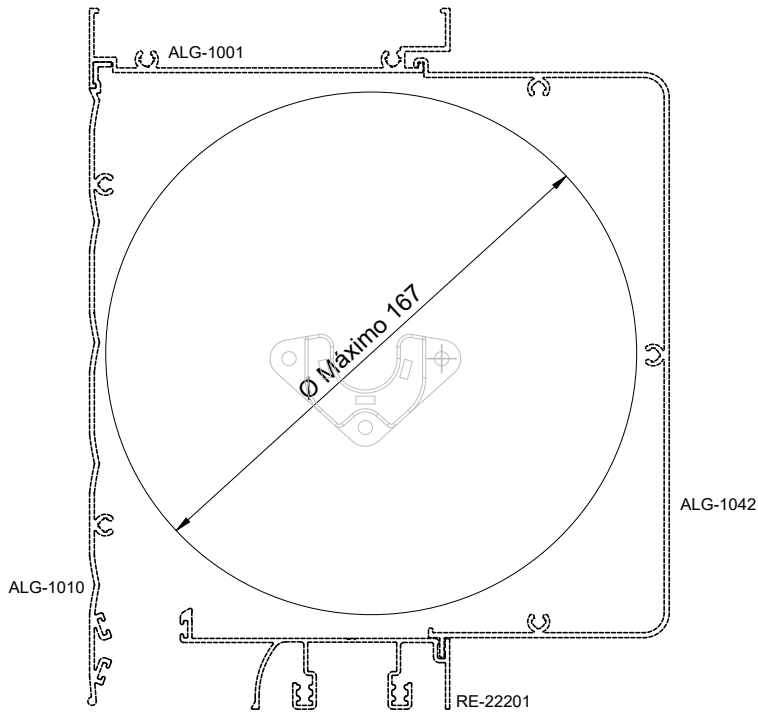
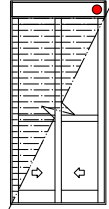
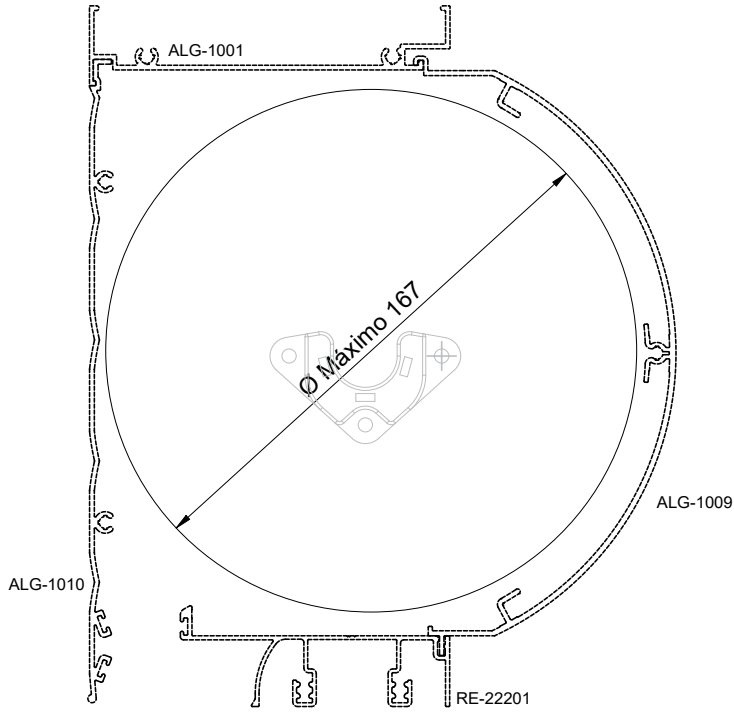

DIMENSÕES DO ROLO DA PERSIANA EM MM		
H = ALTURA TOTAL DO CAIXILHO	DIÂMETRO DO ROLO	
	40	60
1000	120	125
1300	130	135
1600	140	145
1900	150	155
2200	160	165
2500	170	175
2700	175	180

obs.: considerando fita de fixação da esteira, palheta de 41mm

Disco alinhador da persiana		
Código	Tubo (A)	Cota (B)
DAP-0001	DS-238 (40)	Ø 116
DAP-0002	DS-238 (40)	Ø 135
DAP-0003	MN-015 (60)	Ø 116
DAP-0004	MN-015 (60)	Ø 135
DAP-0005	MN-015 (60)	Ø 156

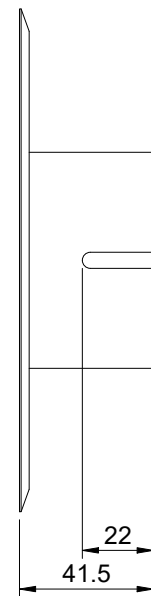
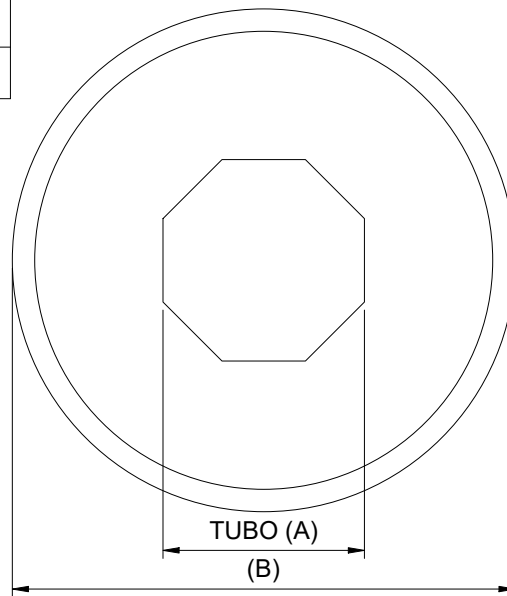
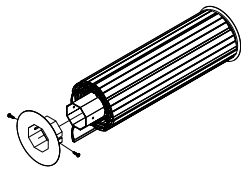
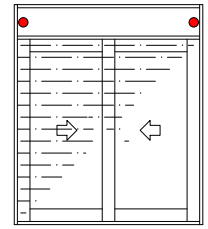

FPE-0001	Fixador da esteira
	cor: inox

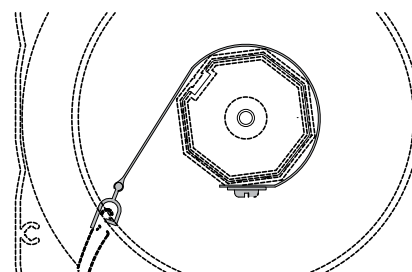
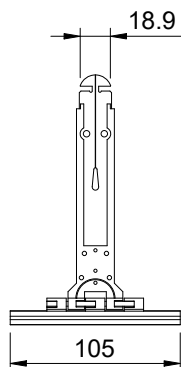
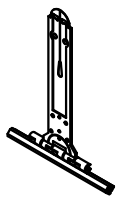
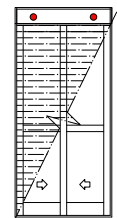

TMT-0005	Tampa caixa integrada janela
	Polimero cor: preto / branco

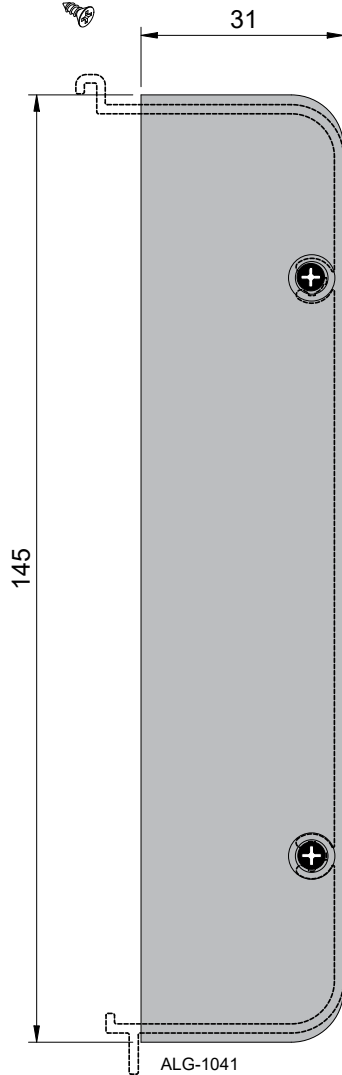
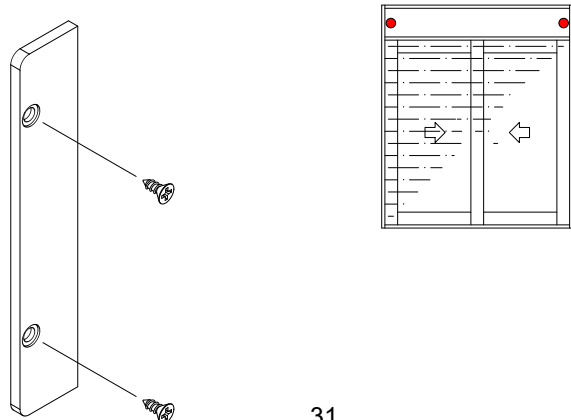

TMT-0006	Tampa caixa integrada janela
	Polimero cor: preto / branco

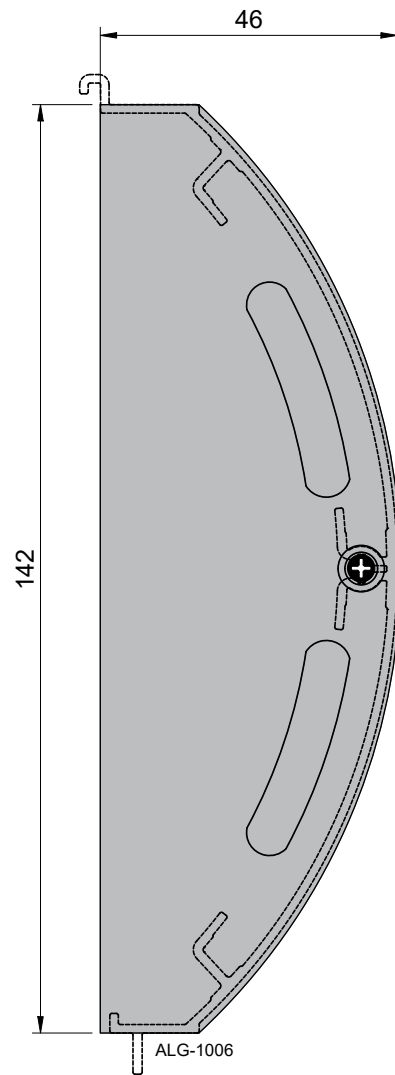
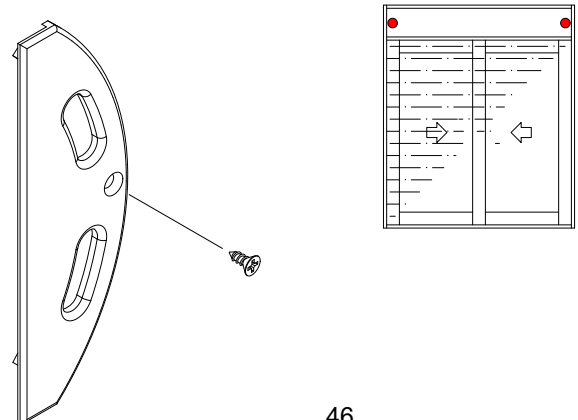

TMT-0007	Tampa caixa integrada porta
	Polimero cor: preto / branco

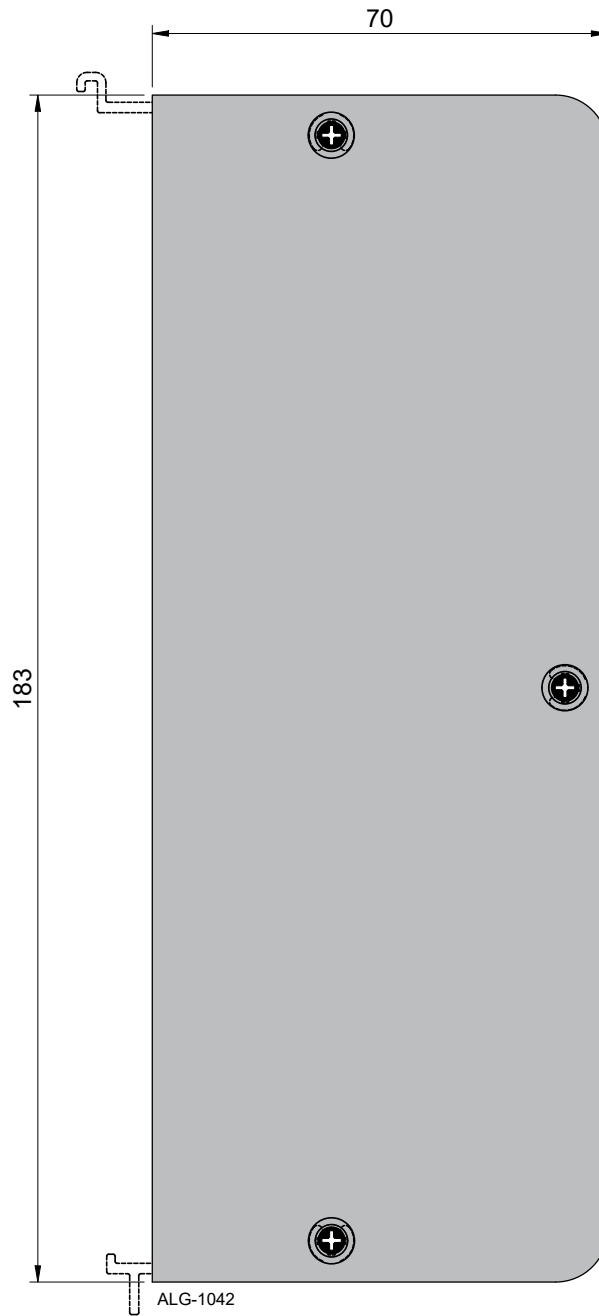
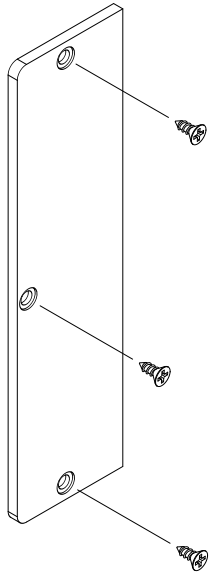
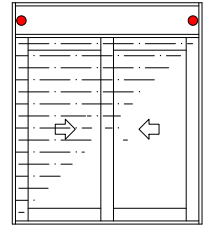

TMT-0008	Tampa caixa integrada porta
	Polimero cor: preto / branco

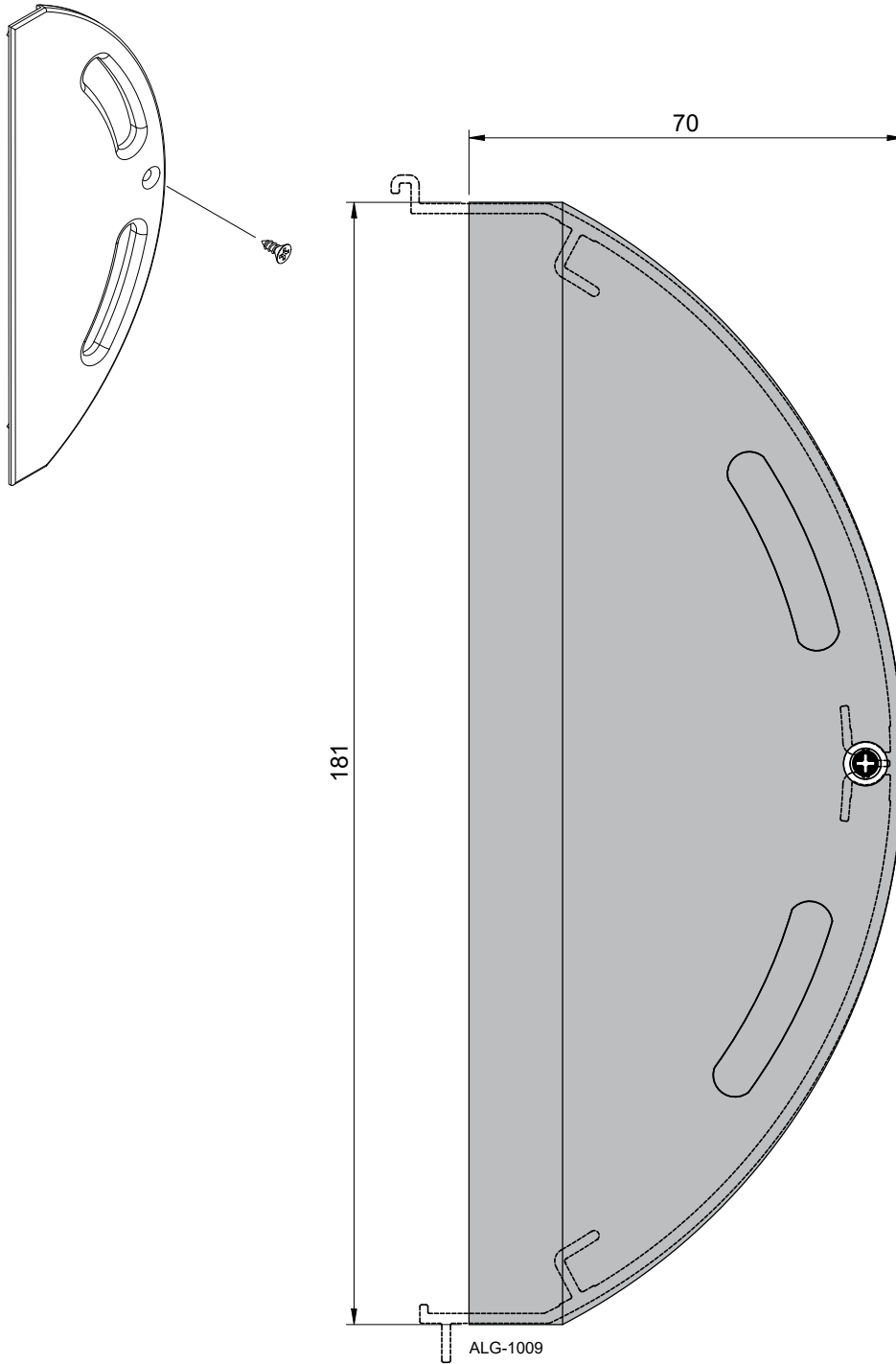
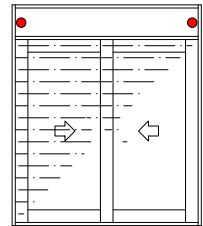

ECV-0006B	Escova de vedação 5x6 com barreira plástica
	cor: preto / branco / cinza

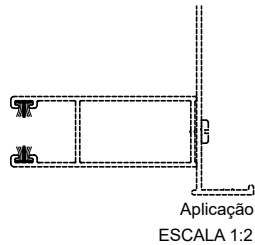
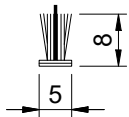
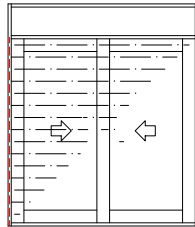
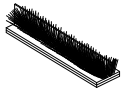

ECV-0006	Escova de vedação 5x8
	cor: preto / branco / cinza

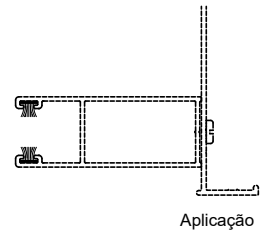
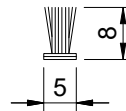
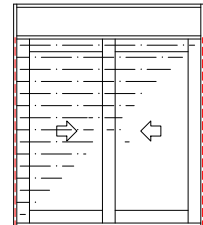
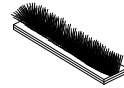

ECV-0011	Escova de vedação 5x12
	cor: preto / branco / cinza

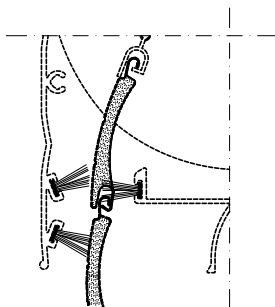
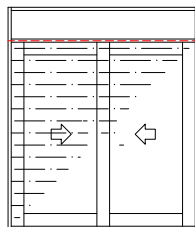
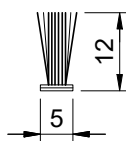
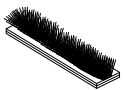

ECV-0011B	Escova de vedação 5x12 com barreira plástica
	cor: preto / branco / cinza

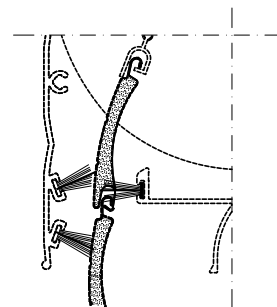
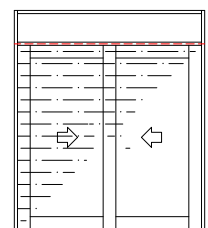
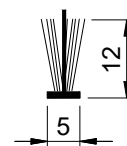
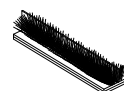

ECV-0004	Escova de vedação 5x7
	cor: preto / branco / cinza

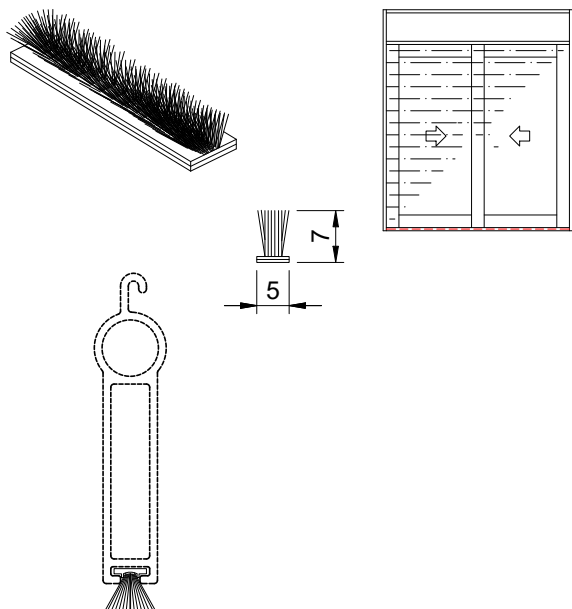

PCP-4245	Parafuso cabeça panela 4.2x25 aço inox
	fixa caixa da persiana

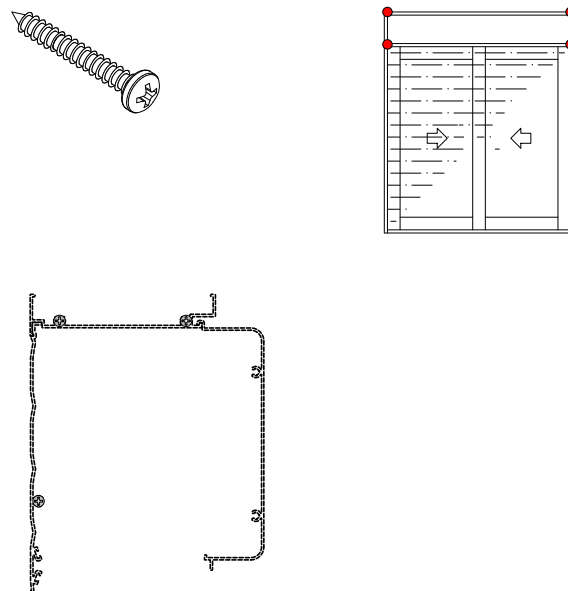

GXT-1155	Guarnição de EPDM
----------	-------------------

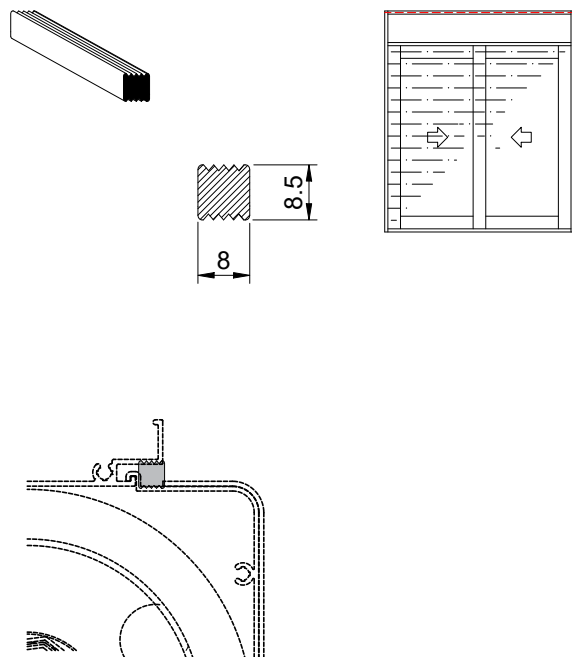

PCP-4832PL	Parafuso cabeça panela 4.8x32 ponta lisa aço inox
	fixa marcos e folhas

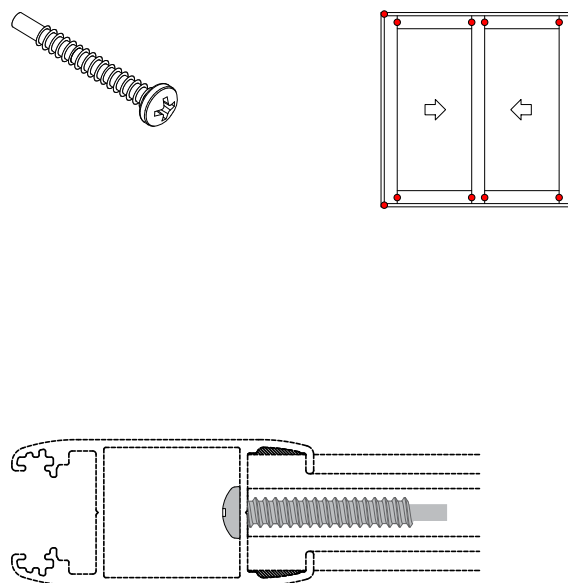

PCP-4213	Parafuso cabeça panela 4.2x13 aço inox
	ver aplicações

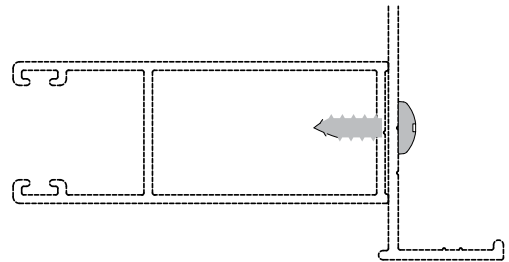
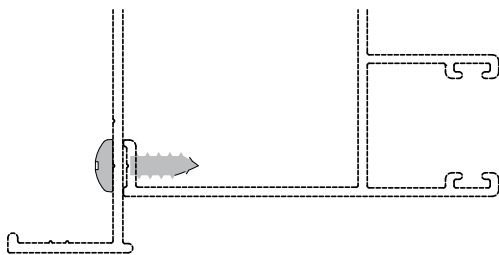
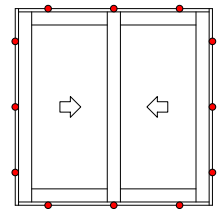
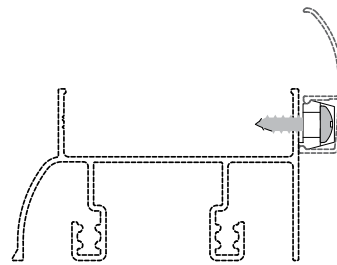
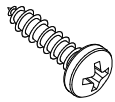

5

Fichas Técnicas

MONTAGENS / TABELAS

JANELA DE CORRER 2 FOLHAS PARA 2 PLANOS	112
JANELA DE CORRER 2 FOLHAS PARA 2 PLANOS COM BANDEIRA E PEITORIL FIXOS	126
JANELA DE CORRER 2 FOLHAS PARA 2 PLANOS COM BANDEIRA FIXA	118
JANELA DE CORRER 2 FOLHAS PARA 2 PLANOS COM MARCO LATERAL COM MATA-JUNTA SOLIDARIZADOS	115
JANELA DE CORRER 2 FOLHAS PARA 2 PLANOS COM PEITORIL FIXO	122
JANELA DE CORRER 2 FOLHAS PARA 2 PLANOS COM PEITORIL FIXO E PERSIANA INTEGRADA MANUAL	140
JANELA DE CORRER 2 FOLHAS PARA 2 PLANOS COM PERSIANA INTEGRADA COM MOTOR	146
JANELA DE CORRER 2 FOLHAS PARA 2 PLANOS COM PERSIANA INTEGRADA COM MOTOR	151
JANELA DE CORRER 2 FOLHAS PARA 2 PLANOS COM PERSIANA INTEGRADA COM MOTOR	156
JANELA DE CORRER 2 FOLHAS PARA 2 PLANOS COM PERSIANA INTEGRADA MANUAL	130
JANELA DE CORRER 2 FOLHAS PARA 2 PLANOS COM PERSIANA INTEGRADA MANUAL	135
JANELA DE CORRER 2 FOLHAS PARA 2 PLANOS FIXAÇÃO DIRETO NO CONCRETO SEM CONTRAMARCO	260
JANELA DE CORRER 3 FOLHAS PARA 3 PLANOS	229
JANELA DE CORRER 3 FOLHAS PARA 3 PLANOS COM BANDEIRA E PEITORIL FIXOS	241
JANELA DE CORRER 3 FOLHAS PARA 3 PLANOS COM BANDEIRA FIXA	233
JANELA DE CORRER 3 FOLHAS PARA 3 PLANOS COM PEITORIL FIXO	237
JANELA DE CORRER 3 FOLHAS SENDO 2 COM VENEZIANA E 1 EM VIDRO	245
JANELA DE CORRER 4 FOLHAS PARA 2 PLANOS COM BANDEIRA E PEITORIL FIXO	205
JANELA DE CORRER 4 FOLHAS PARA 2 PLANOS COM BANDEIRA FIXA	197
JANELA DE CORRER 4 FOLHAS PARA 2 PLANOS COM PEITORIL FIXO	201
JANELA DE CORRER 4 FOLHAS PARA 2 PLANOS	194
JANELA DE CORRER 4 FOLHAS PARA 2 PLANOS COM PERSIANA INTEGRADA COM MOTOR	224
JANELA DE CORRER 4 FOLHAS PARA 2 PLANOS COM PERSIANA INTEGRADA MANUAL	209
JANELA DE CORRER 4 FOLHAS PARA 2 PLANOS COM PERSIANA INTEGRADA MANUAL	214
JANELA DE CORRER 4 FOLHAS PARA 2 PLANOS COM PERSIANA INTEGRADA MANUAL	219
PORTA DE CORRER 2 FOLHAS PARA 2 PLANOS	162
PORTA DE CORRER 2 FOLHAS PARA 2 PLANOS COM BANDEIRA FIXA	171
PORTA DE CORRER 2 FOLHAS PARA 2 PLANOS COM PERSIANA INTEGRADA COM MOTOR	184
PORTA DE CORRER 2 FOLHAS PARA 2 PLANOS COM PERSIANA INTEGRADA COM MOTOR	190
PORTA DE CORRER 2 FOLHAS PARA 2 PLANOS COM PERSIANA INTEGRADA MANUAL	174
PORTA DE CORRER 2 FOLHAS PARA 2 PLANOS COM PERSIANA INTEGRADA MANUAL	179
PORTA DE CORRER 2 FOLHAS PARA 2 PLANOS FIXAÇÃO DIRETO NO CONCRETO SEM CONTRAMARCO	263
PORTA DE CORRER 2 FOLHAS PARA 2 PLANOS MARCO LATERAL COM MATA-JUNTA SOLIDARIZADOS	166
PORTA DE CORRER 3 FOLHAS PARA 3 PLANOS	252
PORTA DE CORRER 3 FOLHAS PARA 3 PLANOS COM BANDEIRA FIXA	256
PORTA DE CORRER 3 FOLHAS SENDO 2 COM VENEZIANA E 1 EM VIDRO	248

JANELA DE CORRER
2 FOLHAS PARA 2 PLANOS

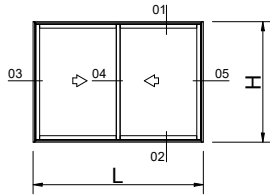

RE22-JCR200

VER COMBINAÇÕES DE PERFIS
NA SESSÃO: DETALHES

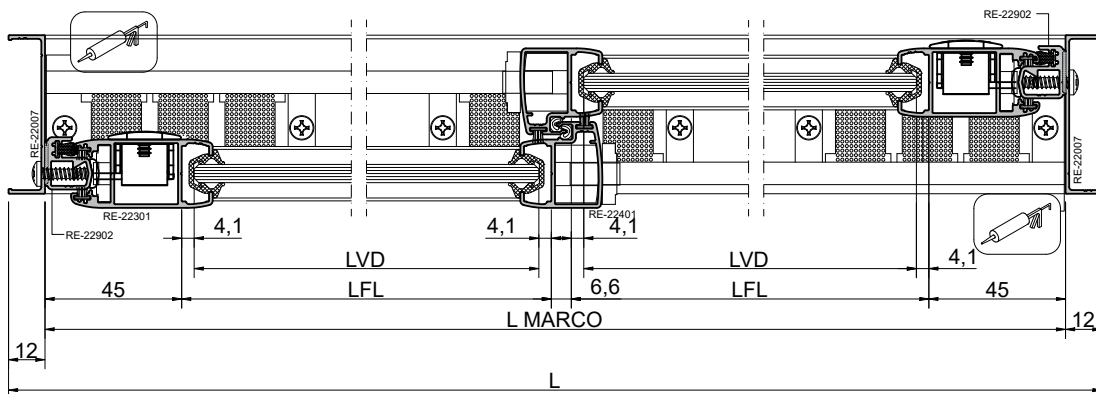
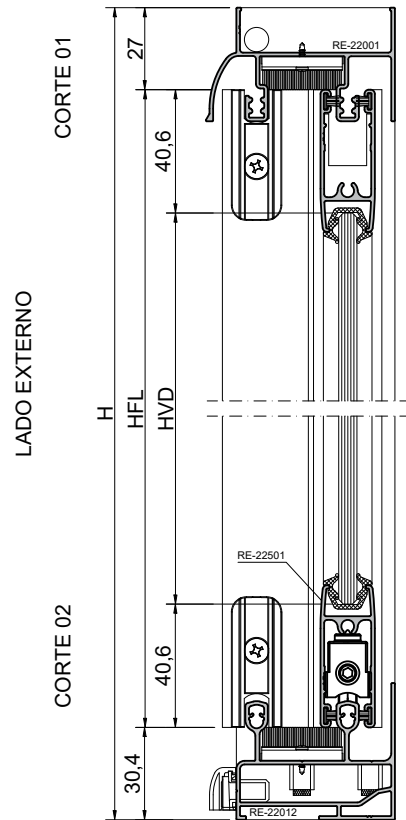







CORTE 03

CORTE 04
LADO EXTERNO







CORTE 05
ESC.: 1:2

JANELA DE CORRER

2 FOLHAS PARA 2 PLANOS

PERFIS					
CROQUI	CÓDIGO	CORTE	TAMANHO	QDE.	USINAGEM
	RE-22001	90 / 90	L-24	1	
	RE-22012	90 / 90	L-24	1	USI 11
	RE-22007	90 / 90	H	2	USI 1
	RE-22902	90 / 90	H-57	2	USI 8
	RE-22501	90 / 90	(L-121) / 2	4	
	RE-22301	90 / 90	H-57	2	USI 13
	22401	90 / 90	H-57	2	USI 14

VIDRO JANELA	
LARGURA	(L-137)/2
ALTURA	H-139

GUARNIÇÕES/ESCOVAS			
CROQUI	CÓDIGO	MEDIDA	DESCRIÇÃO
	QL-5375	2*H	Qlon de vedação
	GXT-1128	(2*L)+(4*H)	Gaxeta p/ vidro 6 mm
	GNC-0001	2*H	Mão de amigo
	ECV-0010B	4*L	Escova 5X4 com barreira plastica
	EVC-0010B	4*H	Escova 5X4 com barreira plastica
	EVC-0001B	2*H	Escova 5X6 com barreira plastica

JANELA DE CORRER
2 FOLHAS PARA 2 PLANOS

COMPONENTES				
CROQUI	REF.	QDE.	DESCRIÇÃO	OBS.
	PCP-4832PL	16	Fixação do marco/folha	
	PCP-3995	$((H/350)+1) \times 2$	Fixa mata junta	
	VDA-22001	6	Vedação superior e inferior	Ver tabela de componentes
	DRN-22001	2	Dreno	Ver tabela de componentes
	CTF-0001	2	Contra fecho	Ver tabela de componentes
	FCH-0002	2	Fecho concha JANELA	Ver tabela de componentes
	TRV-22001	2	Lingueta fecho concha	Ver tabela de componentes
	GDE-22001	4	Guia da folha lateral	Ver tabela de componentes
	GDE-22002	4	Guia da folha mão de amigo	Ver tabela de componentes
	RLD-22001	4	Roldana da folha	Ver tabela de componentes
	BTE-0008	4	Batedeira da folha	Ver tabela de componentes
	VDA-22005	8	Espuma polietileno fechamento interno	Ver tabela de componentes
	VDA-0011	2	Lã pet isolamento dos rasgos das conchas	Ver tabela de componentes

JANELA DE CORRER

2 FOLHAS PARA 2 PLANOS

COM MARCO LATERAL COM MATA-JUNTA SOLIDARIZADOS

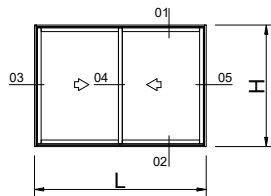

RE22-JCR200

VER COMBINAÇÕES DE PERFIS
NA SESSÃO: DETALHES

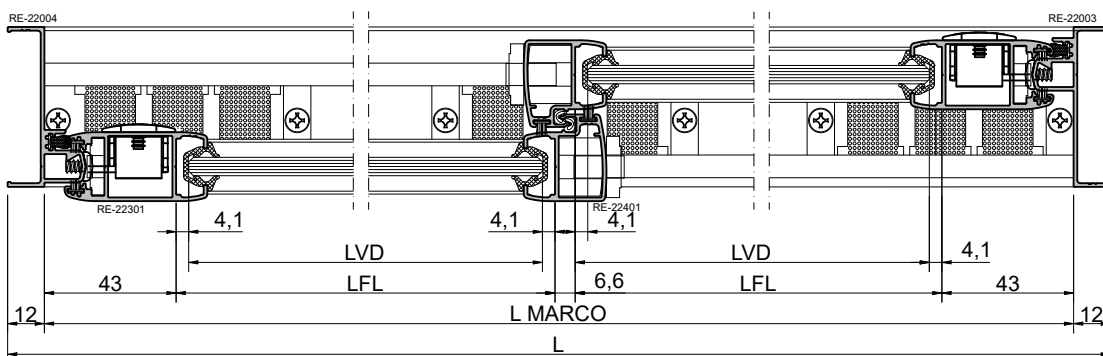
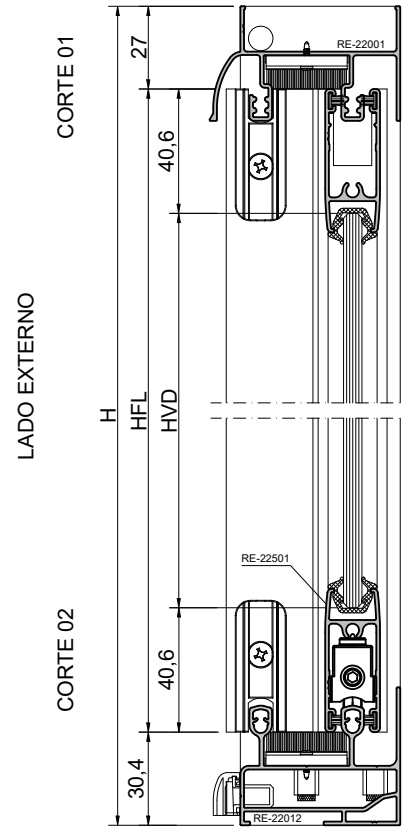

CORTE 03







CORTE 04
LADO EXTERNO

CORTE 05







ESC.: 1:2

JANELA DE CORRER
2 FOLHAS PARA 2 PLANOS

**COM MARCO LATERAL COM
MATA-JUNTA SOLIDARIZADOS**

PERFIS					
CROQUI	CÓDIGO	CORTE	TAMANHO	QDE.	USINAGEM
	RE-22001	90 / 90	L-24	1	
	RE-22012	90 / 90	L-24	1	USI 11
	RE-22003	90 / 90	H	1	USI 2
	RE-22004	90 / 90	H	1	USI 2
	RE-22501	90 / 90	(L-117) / 2	4	
	RE-22301	90 / 90	H-57	2	USI 13
	RE-22401	90 / 90	H-57	2	USI 14

VIDRO JANELA	
LARGURA	(L-133)/2
ALTURA	H-139

GUARNIÇÕES/ESCOVAS			
CROQUI	CÓDIGO	MEDIDA	DESCRIÇÃO
	QL-5375	2*H	Qlon de vedação
	GXT-1128	(2*L)+(4*H)	Gaxeta p/ vidro 6 mm
	GNC-0001	2*H	Mão de amigo
	ECV-0010B	4*L	Escova 5X4 com barreira plastica
	EVC-0010B	4*H	Escova 5X4 com barreira plastica
	EVC-0001B	2*H	Escova 5X6 com barreira plastica

JANELA DE CORRER 2 FOLHAS PARA 2 PLANOS

COM MARCO LATERAL COM MATA-JUNTA SOLIDARIZADOS

COMPONENTES				
CROQUI	REF.	QDE.	DESCRIÇÃO	OBS.
	PCP-4832PL	16	Fixação do marco/folha	
	VDA-22001	6	Vedação superior e inferior	Ver tabela de componentes
	DRN-22001	2	Dreno	Ver tabela de componentes
	CTF-0001	2	Contra fecho	Ver tabela de componentes
	FCH-0002	2	Fecho concha JANELA	Ver tabela de componentes
	TRV-22001	2	Lingueta fecho concha	Ver tabela de componentes
	GDE-22001	4	Guia da folha lateral	Ver tabela de componentes
	GDE-22002	4	Guia da folha mão de amigo	Ver tabela de componentes
	RLD-22001	4	Roldana da folha	Ver tabela de componentes
	BTE-0008	4	Batedeira da folha	Ver tabela de componentes
	VDA-22005	8	Espuma polietileno fechamento interno	Ver tabela de componentes
	VDA-0011	2	Lã pet isolamento dos rasgos das conchas	Ver tabela de componentes

JANELA DE CORRER
2 FOLHAS PARA 2 PLANOS

COM BANDEIRA FIXA

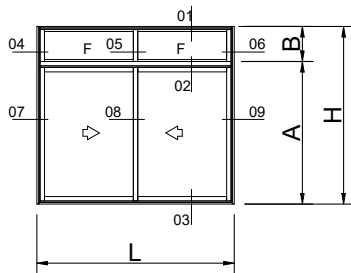

RE22-JCR201

VER COMBINAÇÕES DE PERFIS
NA SESSÃO: DETALHES

LADO EXTERNO

CORTE 01

CORTE 02

CORTE 03

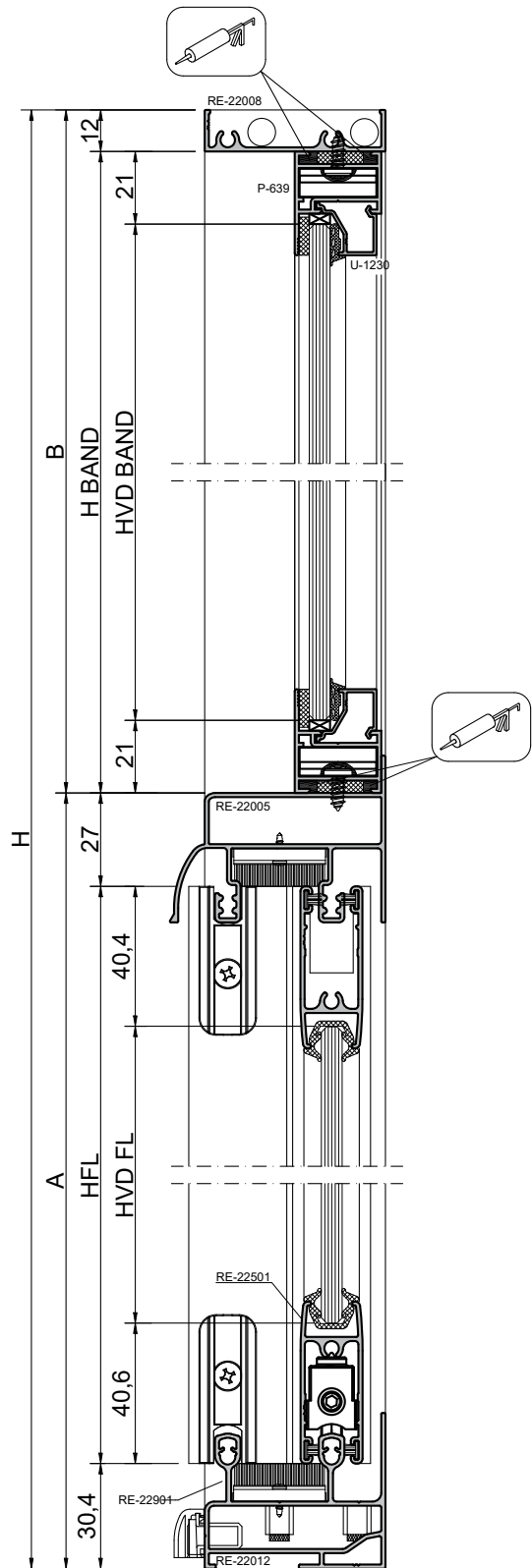

ESC.: 1:2

JANELA DE CORRER

2 FOLHAS PARA 2 PLANOS

COM BANDEIRA FIXA

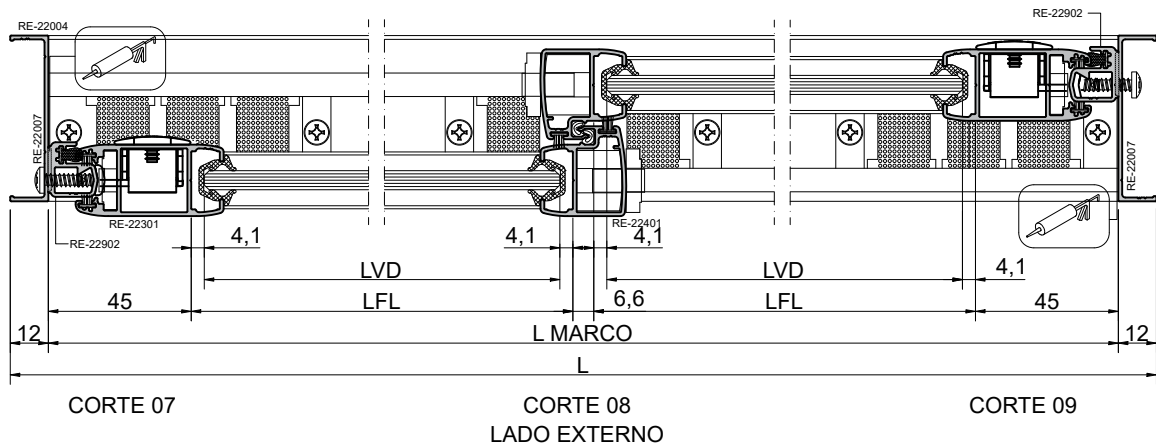
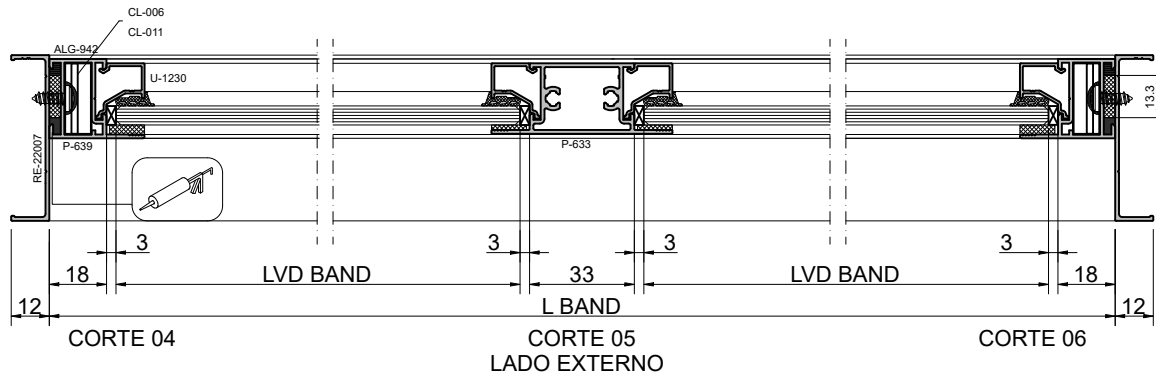















GUARNIÇÕES/ESCOVAS			
CROQUI	CÓDIGO	MEDIDA	DESCRIÇÃO
	QL-5375	2*A	Qlon de vedação
	GXT-1128	(2*L)+(4*A)	Gaxeta p/ vidro 6 mm
	GNC-0001	2*A	Mão de amigo
	ECV-0010B	4*L	Escova 5X4 com barreira plastica
	EVC-0010B	4*H	Escova 5X4 com barreira plastica
	EVC-0001B	2*H	Escova 5X6 com barreira plastica
	GUA-259	(2*L)+(4*B)	Gaxeta de EPDM interna vidro 6mm

VIDRO JANELA	
LARGURA	(L-137)/2
ALTURA	A-138

VIDRO BANDEIRA	
LARGURA	(L-105)/2
ALTURA	B-54

ESC.: 1:2

JANELA DE CORRER
2 FOLHAS PARA 2 PLANOS
COM BANDEIRA FIXA

PERFIS					
CROQUI	CÓDIGO	CORTE	TAMANHO	QDE.	USINAGEM
	RE-22008	90 / 90	L-24	1	
	RE-22005	90 / 90	L-24	1	
	RE-22012	90 / 90	L-24	1	USI 11
	RE-22007	90 / 90	H	2	USI 5
	RE-22902	90 / 90	A-57	2	USI 8
	RE-22501	90 / 90	(L-121)/2	4	
	RE-22301	90 / 90	A-57	2	USI 13
	RE-22401	90 / 90	A-57	2	USI 14
	P-639	45 / 45	L-24	2	
	P-639	45 / 45	B-12	2	
	P-633	90 / 90	B-48	1	
	U-1230	90 / 90	(L-93)/2	4	
	U-1230	90 / 90	B-72	4	
	CL-006	90 / 90	21	4	
	CL-011	90 / 90	21	8	

JANELA DE CORRER 2 FOLHAS PARA 2 PLANOS

COM BANDEIRA FIXA

COMPONENTES				
CROQUI	REF.	QDE.	DESCRIÇÃO	OBS.
	PCP-4832PL	24	Fixação marco/folha travessa	
	PCP-3995	$((A/350)+1)X2$	Fixa mata junta	
	PCP-3995	$((2*(L+B))/350)+1$	Fixa bandeira	
	VDA-22001	6	Vedação superior e inferior	Ver tabela de componentes
	DRN-22001	2	Dreno	Ver tabela de componentes
	CTF-0001	2	Contra fecho	Ver tabela de componentes
	FCH-0002	2	Fecho concha JANELA	Ver tabela de componentes
	TRV-22001	2	Lingueta fecho concha	Ver tabela de componentes
	GDE-22001	4	Guia da folha lateral	Ver tabela de componentes
	GDE-22002	4	Guia da folha mão de amigo	Ver tabela de componentes
	RLD-22001	4	Roldana da folha	Ver tabela de componentes
	BTE-0008	4	Batedeira da folha	Ver tabela de componentes
	VDA-22005	8	Espuma polietileno fechamento interno	Ver tabela de componentes
	VDA-0011	2	Lã pet isolamento dos rasgos das conchas	Ver tabela de componentes
	P020010	16	Calço do vidro EPDM 6x3x50	Calço do vidro bandeira
	ESP-11x4	$(2*(L+B))$	Espuma polietileno 11x4	Vedação quadro fixo
	GUA-258	$(2*(L+B))$	Espuma polietileno 11X4	Esp. vidro 6 mm
	GUA-171	$2*B$	Espuma polietileno 11x3	Esp. vidro 6 mm coluna

JANELA DE CORRER
2 FOLHAS PARA 2 PLANOS

COM PEITORIL FIXO

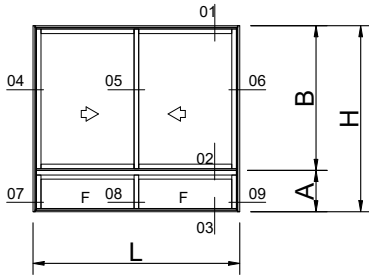

RE22-JCR202

VER COMBINAÇÕES DE PERFIS
NA SESSÃO: DETALHES

LADO EXTERNO

CORTE 01





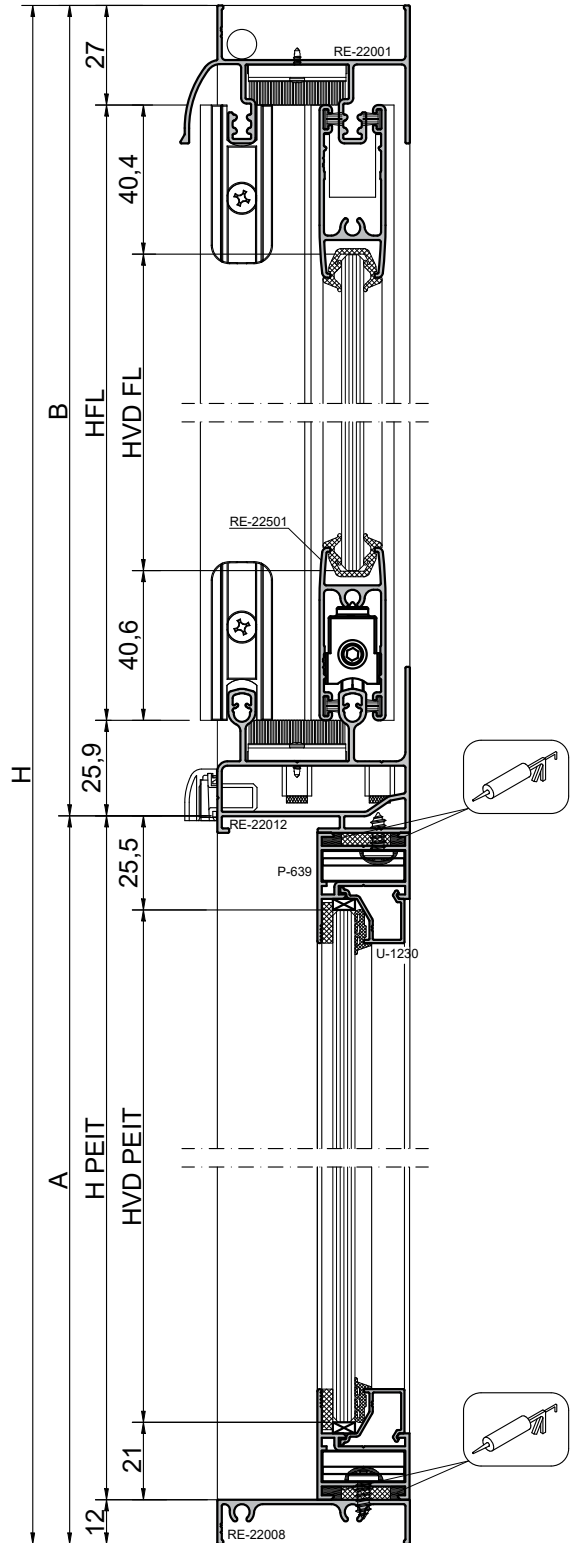









CORTE 02

CORTE 03



ESC.: 1:2













JANELA DE CORRER
2 FOLHAS PARA 2 PLANOS
COM PEITORIL FIXO

PERFIS					
CROQUI	CÓDIGO	CORTE	TAMANHO	QDE.	USINAGEM
	RE-22008	90 / 90	L-24	1	
	RE-22001	90 / 90	L-24	1	
	RE-22012	90 / 90	L-24	1	USI 11
	RE-22007	90 / 90	H	2	USI 5
	RE-22902	90 / 90	B-53	2	USI 8
	RE-22501	90 / 90	(L-121)/2	4	
	RE-22301	90 / 90	B-53	2	USI 13
	RE-22401	90 / 90	B-53	2	USI 14
	P-639	45 / 45	L-24	2	
	P-639	45 / 45	A-17	2	
	P-633	90 / 90	A-52	1	
	U-1230	90 / 90	(L-93)/2	4	
	U-1230	90 / 90	A-76	4	
	CL-006	90 / 90	21	4	
	CL-011	90 / 90	21	8	

JANELA DE CORRER

2 FOLHAS PARA 2 PLANOS

COM PEITORIL FIXO

COMPONENTES				
CROQUI	REF.	QDE.	DESCRIÇÃO	OBS.
	PCP-4832PL	24	Fixação marco/folha travessa	
	PCP-3995	$((B/350)+1)*2$	Fixa mata junta	
	PCP-3995	$((2*(L+A))/350)+1$	Fixa peitoril	
	VDA-22001	6	Vedação superior e inferior	Ver tabela de componentes
	DRN-22001	2	Dreno	Ver tabela de componentes
	CTF-0001	2	Contra fecho	Ver tabela de componentes
	FCH-0002	2	Fecho concha JANELA	Ver tabela de componentes
	TRV-22001	2	Lingueta fecho concha	Ver tabela de componentes
	GDE-22001	4	Guia da folha lateral	Ver tabela de componentes
	GDE-22002	4	Guia da folha mão de amigo	Ver tabela de componentes
	RLD-22001	4	Roldana da folha	Ver tabela de componentes
	BTE-0008	4	Batedeira da folha	Ver tabela de componentes
	VDA-22005	8	Espuma polietileno fechamento interno	Ver tabela de componentes
	VDA-0011	2	Lã pet isolamento dos rasgos das conchas	Ver tabela de componentes
	P020010	16	Calço do vidro EPDM 6x3x50	Calço do vidro peitoril
	ESP-11x4	$(2*(L+A))$	Espuma polietileno 11x4	Vedação quadro fixo
	GUA-258	$(2*(L+A))$	Espuma polietileno 11x4	Esp. vidro 6 mm
	GUA-171	$2*A$	Espuma polietileno 11x3	Esp. vidro 6 mm coluna

JANELA DE CORRER
2 FOLHAS PARA 2 PLANOS

COM BANDEIRA E PEITORAL FIXOS

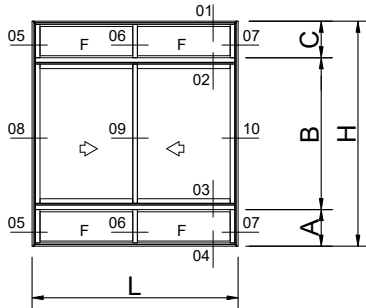

RE22-JCR203

VER COMBINAÇÕES DE PERFIS
NA SESSÃO: DETALHES

LADO EXTERNO

CORTE 01

CORTE 02

CORTE 03

CORTE 04

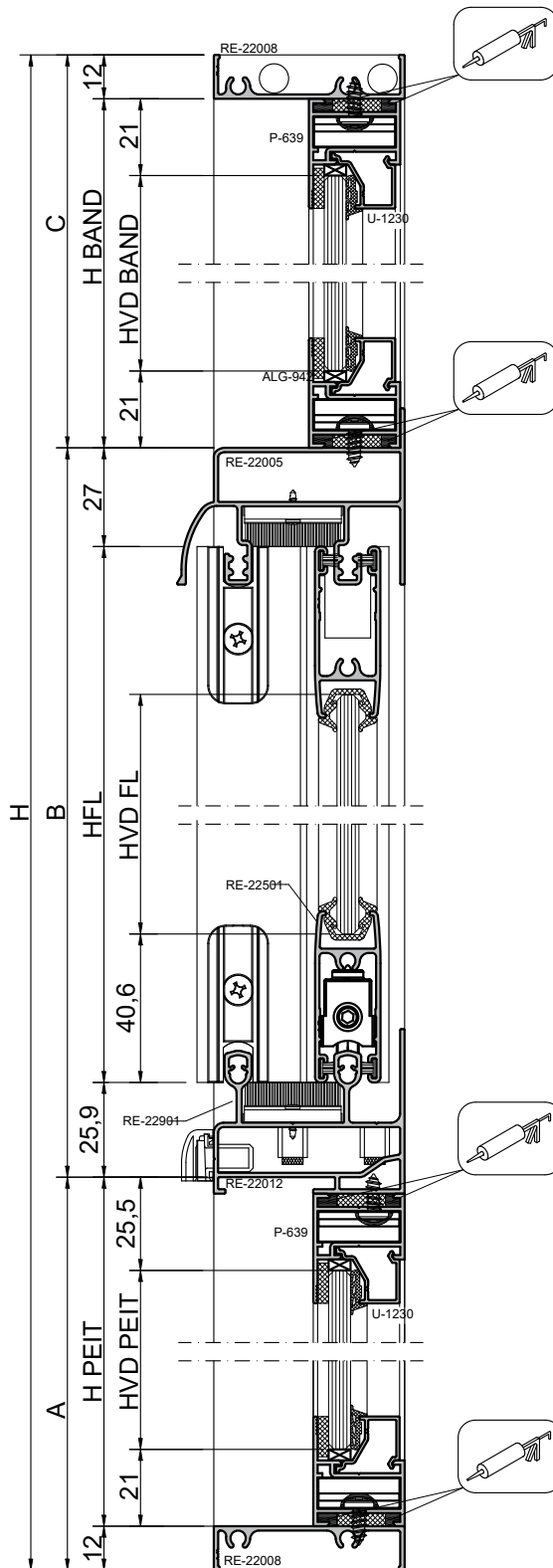

ESC.: 1:2

JANELA DE CORRER

2 FOLHAS PARA 2 PLANOS

COM BANDEIRA E PEITORAL FIXOS

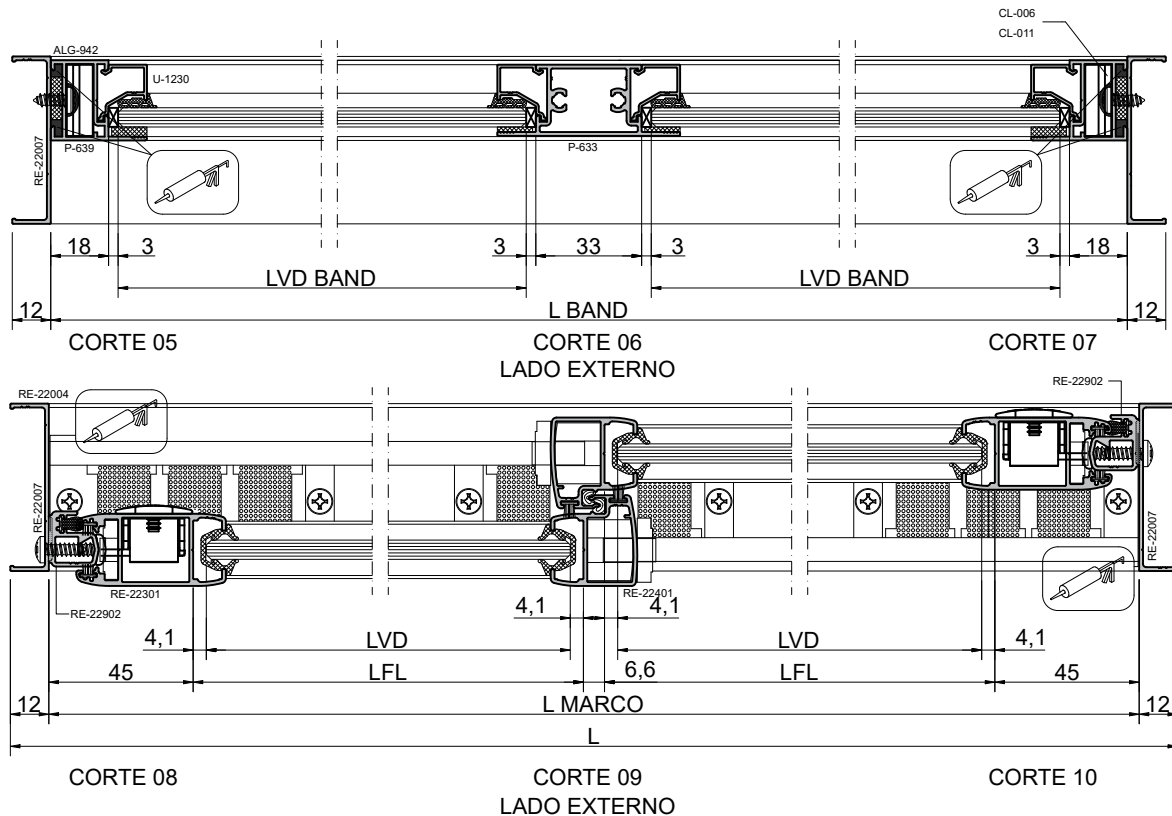

GUARNIÇÕES/ESCOVAS			
CROQUI	CÓDIGO	MEDIDA	DESCRIÇÃO
	QL-5375	2*B	Qlon de vedação
	GXT-1128	(2*L)+(4*B)	Gaxeta p/ vidro 6 mm
	GNC-0001	2*B	Mão de amigo
	ECV-0010B	4*L	Escova 5X4 com barreira plastica
	EVC-0010B	4*B	Escova 5X4 com barreira plastica
	EVC-0001B	2*B	Escova 5X6 com barreira plastica
	GUA-259	(2*L)+(4*C)	Gaxeta de EPDM interna vidro 6mm band
	GUA-259	(2*L)+(4*A)	Gaxeta de EPDM interna vidro 6mm

VIDRO BANDEIRA	
LARGURA	(L-105)/2
ALTURA	C-54
VIDRO JANELA	
LARGURA	(L-137)/2
ALTURA	B-134
VIDRO PEITORIL	
LARGURA	(L-105)/2
ALTURA	A-58







ESC.: 1:2

JANELA DE CORRER
2 FOLHAS PARA 2 PLANOS
COM BANDEIRA E PEITORAL FIXOS

PERFIS					
CROQUI	CÓDIGO	CORTE	TAMANHO	QDE.	USINAGEM
	RE-22008	90 / 90	L-24	2	
	RE-22001	90 / 90	L-24	1	
	RE-22012	90 / 90	L-24	1	USI 11
	RE-22007	90 / 90	H	2	USI 5
	RE-22902	90 / 90	B-53	2	USI 8
	RE-22501	90 / 90	(L-121)/2	4	
	RE-22301	90 / 90	B-53	2	USI 13
	RE-22401	90 / 90	B-53	2	USI 14
	P-639	45 / 45	L-24	2	band.
	P-639	45 / 45	C-12	2	band.
	P-633	90 / 90	C-48	1	band.
	U-1230	90 / 90	(L-93)/2	4	band.
	U-1230	90 / 90	C-72	4	band.
	P-639	45 / 45	L-24	2	peitoril
	P-639	45 / 45	A-17	2	peitoril
	P-633	90 / 90	A-52	1	peitoril
	U-1230	90 / 90	(L-93)/2	4	peitoril
	U-1230	90 / 90	A-76	4	peitoril
	CL-006	90 / 90	21	8	
	CL-011	90 / 90	21	16	

JANELA DE CORRER 2 FOLHAS PARA 2 PLANOS

COM BANDEIRA E PEITORAL FIXOS

COMPONENTES				
CROQUI	REF.	QDE.	DESCRIÇÃO	OBS.
	PCP-4832PL	20	Fixação marco/folha travessa	
	PCP-3995	$((B/350)+1)*2$	Fixa mata junta	
	PCP-3995	$((2*(L+C))/350)+1$	Fixa bandeira	
	PCP-3995	$((2*(L+A))/350)+1$	Fixa peitoril	
	VDA-22001	6	Vedação superior e inferior	
	DRN-22001	2	Dreno	
	CTF-0001	2	Contra fecho	
	FCH-0002	2	Fecho concha JANELA	Ver tabela de componentes
	TRV-22001	2	Lingueta fecho concha	Ver tabela de componentes
	GDE-22001	4	Guia da folha lateral	Ver tabela de componentes
	GDE-22002	4	Guia da folha mão de amigo	Ver tabela de componentes
	RLD-22001	4	Roldana da folha	Ver tabela de componentes
	BTE-0008	4	Batedeira da folha	Ver tabela de componentes
	VDA-22005	8	Espuma polietileno fechamento interno	Ver tabela de componentes
	VDA-0011	2	Lã pet isolamento dos rasgos das conchas	Ver tabela de componentes
	P020010	32	Calço do vidro EPDM 6x3x50	Calço do vidro bandeira/peitoril
	ESP-11x4	$(2*(L+B))+2*(L+C)$	Espuma polietileno 11x4	Vedação quadro fixo
	GUA-258	$(2*(L+B))+2*(L+C)$	Espuma polietileno 11X4	Esp. vidro 6 mm
	GUA-171	$(2*B)+(2*C)$	Espuma polietileno 11x3	Esp. vidro 6 mm coluna

JANELA DE CORRER
2 FOLHAS PARA 2 PLANOS

COM PERSIANA INTEGRADA
MANUAL

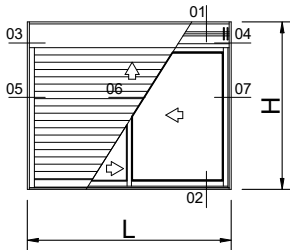

RE22-IJC200

VER COMBINAÇÕES DE PERFIS
NA SESSÃO: DETALHES

LADO EXTERNO





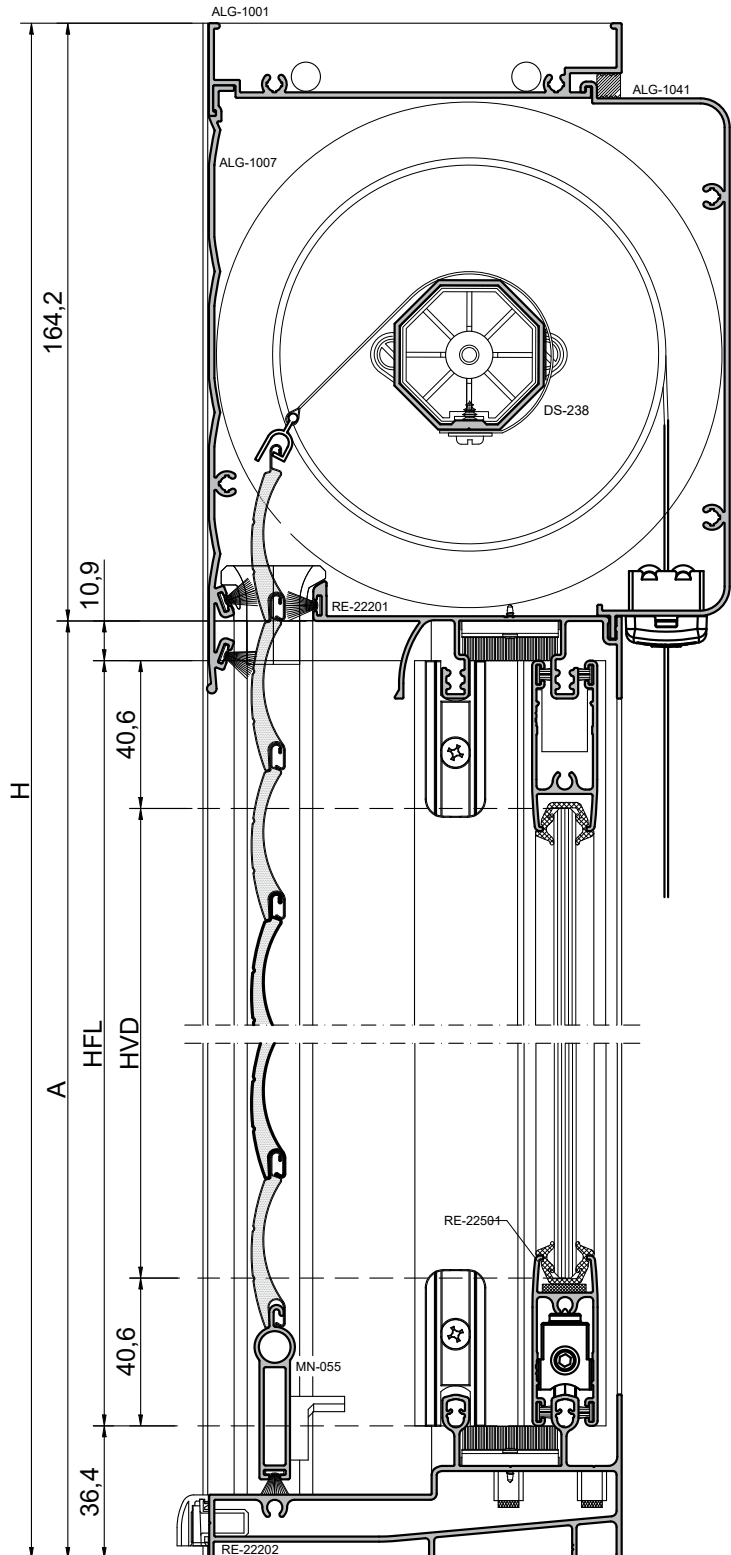

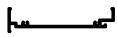
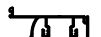

CORTE 01

CORTE 02

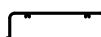
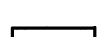
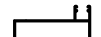
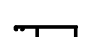

ESC.: 1:2

JANELA DE CORRER
2 FOLHAS PARA 2 PLANOS
COM PERSIANA INTEGRADA MANUAL

PERFIS					
CROQUI	CÓDIGO	CORTE	TAMANHO	QDE.	USINAGEM
	ALG-1001	90 / 90	L-35	1	
	RE-22201	90 / 90	L-35	1	
	RE-22202	90 / 90	L-35	1	
	ALG-1007	90 / 90	L-35	1	
	ALG-1041	90 / 90	L-35	1	
	ALG-1000	90 / 90	H	2	USI 24
	ALG-1004	90 / 90	A-18	1	USI 22
	ALG-1005	90 / 90	A-18	1	USI 21
	DS-238	90 / 90	variável conforme fornecedor recolhedor	1	
	MN-055	90 / 09	L-115	1	
	RE-22902	90 / 90	A-47	2	USI 8
	RE-22501	90 / 90	(L-169)/2	4	
	RE-22301	90 / 90	A-47	2	USI 13
	RE-22401	90 / 90	A-47	2	USI 14

JANELA DE CORRER 2 FOLHAS PARA 2 PLANOS

COM PERSIANA INTEGRADA MANUAL











COMPONENTES				
CROQUI	REF.	QDE.	DESCRIÇÃO	OBS.
	PCP-4832PL	24	Fixação marco/folha travessa	
	PCP-3995	$((A/350)+1)*2$	Fixa mata junta	
	PCP-3995	$((A/350)+1)*3$	Fixa ALG-1004/1005	
	VDA-22001	6	Vedação superior e inferior	Ver tabela de componentes
	DRN-22001	2	Dreno	Ver tabela de componentes
	CTF-0001	2	Contra fecho	Ver tabela de componentes
	FCH-0002	2	Fecho concha JANELA	Ver tabela de componentes
	TRV-22001	2	Lingueta fecho concha	Ver tabela de componentes
	GDE-22001	4	Guia da folha lateral	Ver tabela de componentes
	GDE-22002	4	Guia da folha mão de amigo	Ver tabela de componentes
	RLD-22001	4	Roldana da folha	Ver tabela de componentes
	BTE-0008	4	Batedeira da folha	Ver tabela de componentes
	VDA-22005	12	Espuma polietileno fechamento interno	Ver tabela de componentes
	VDA-0011	2	Lã pet isolamento os calços de vedação	Ver tabela de componentes
	GPE-0006	2	Guia da Esteira	Ver tabela de componentes

JANELA DE CORRER

2 FOLHAS PARA 2 PLANOS

COM PERSIANA INTEGRADA MANUAL

COMPONENTES				
CROQUI	REF.	QDE.	DESCRIÇÃO	OBS.
	RCO-0001	1	Recolhedor manual janela	Ver tabela de componentes
	GCT-0003	1	Guia inferior da cinta	Ver tabela de componentes
	FPE-0001	4	Fixador da esteira	Ver tabela de componentes
	LPE-0001	2	Limitador da esteira	Ver tabela de componentes
	TMT-0005	2	Tampa da caixa	Ver tabela de componentes
	DAP-0001	2	Disco alinhador da esteira	Ver tabela de componentes
	PAC-0001	VAR	Palheta cega passo 41mm	Ver tabela de componentes
	PAV-0001	VAR	Palheta ventilada passo 41mm	Ver tabela de componentes

GUARNIÇÕES/ESCOVAS			
CROQUI	CÓDIGO	MEDIDA	DESCRIÇÃO
	QL-5375	2*A	Qlon de vedação
	GXT-1128	(2*L)+(4*A)	Gaxeta p/ vidro 6 mm
	GNC-0001	2*A	Mão de amigo
	ECV-0010B	4*L	Escova 5X4 com barreira plastica
	EVC-0010B	4*A	Escova 5X4 com barreira plastica
	EVC-0001B	2*A	Escova 5X6 com barreira plastica
	GXT-1155	L	Gaxeta trava da tampa
	ECV-0012	3*L	Escova 5X12
	ECV-0004	L	Escova 5X7
	ECV-0006	4*A	Escova 5X8

VIDRO JANELA	
LARGURA	(L-185)/2
ALTURA	A-128

JANELA DE CORRER

2 FOLHAS PARA 2 PLANOS

COM PERSIANA INTEGRADA MANUAL

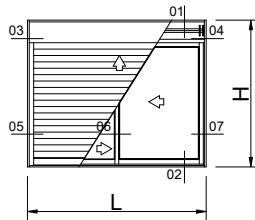

RE22-IJC200

VER COMBINAÇÕES DE PERFIS
NA SESSÃO: DETALHES

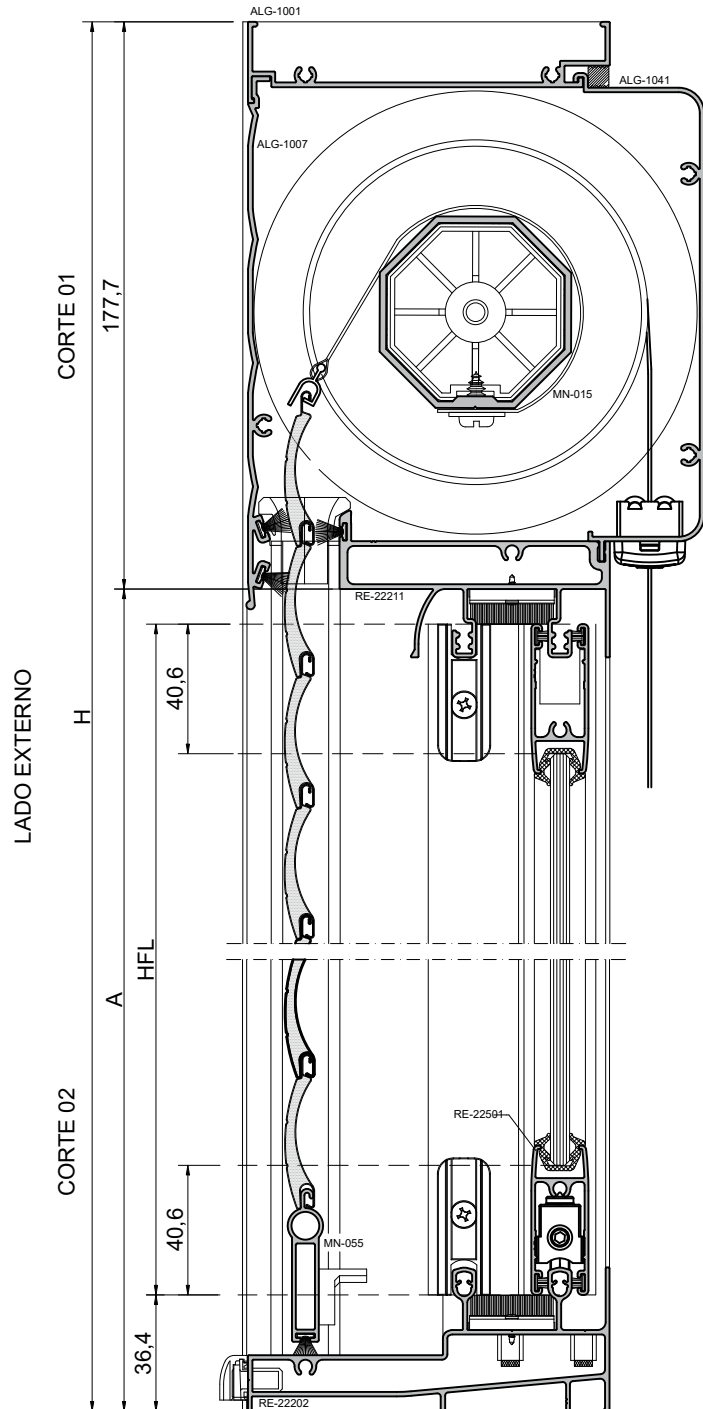

ESC.: 1:2

JANELA DE CORRER
2 FOLHAS PARA 2 PLANOS



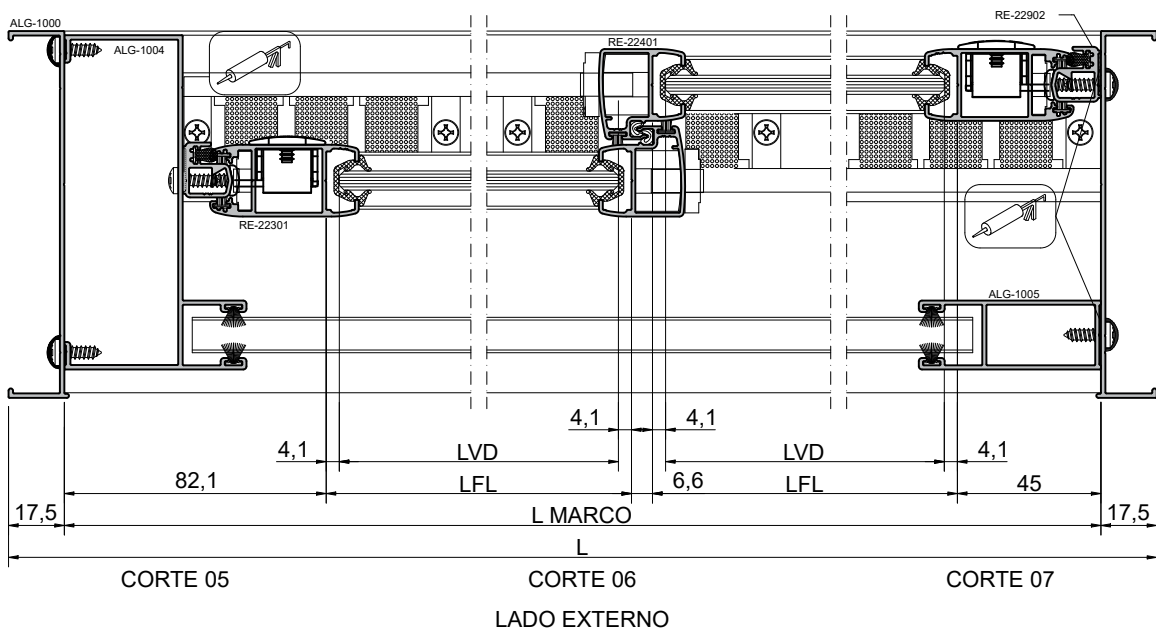
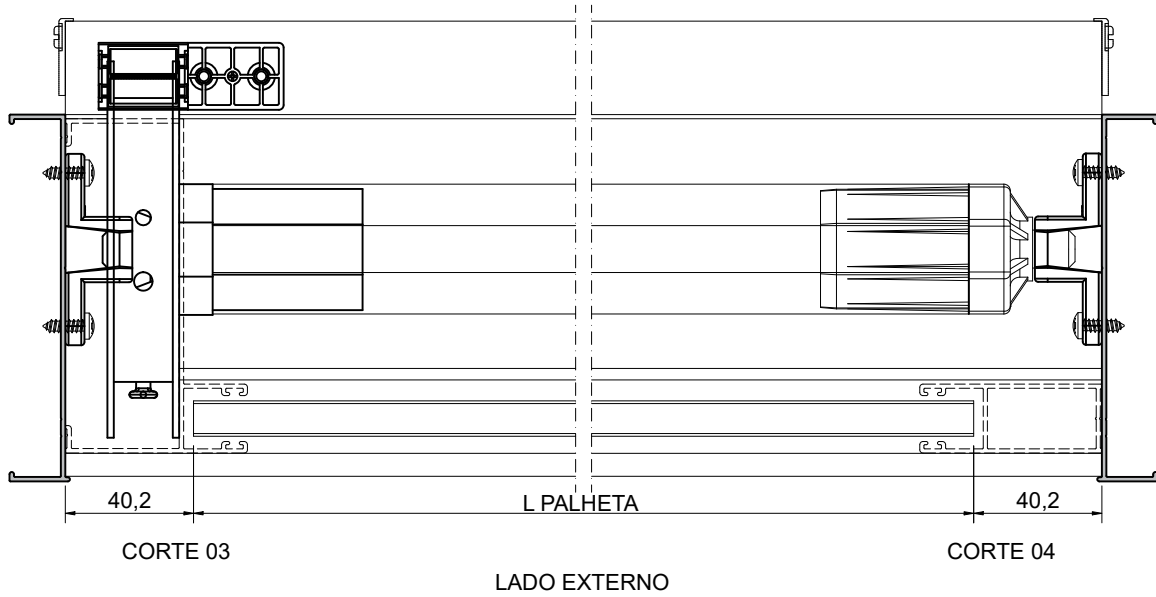





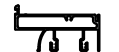

COM PERSIANA INTEGRADA MANUAL

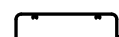
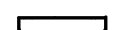
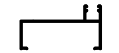

ESC.: 1:2

JANELA DE CORRER 2 FOLHAS PARA 2 PLANOS

COM PERSIANA INTEGRADA MANUAL





PERFIS					
CROQUI	CÓDIGO	CORTE	TAMANHO	QDE.	USINAGEM
	ALG-1001	90 / 90	L-35	1	
	RE-22211	90 / 90	L-35	1	
	RE-22202	90 / 90	L-35	1	
	ALG-1007	90 / 90	L-35	1	
	ALG-1041	90 / 90	L-35	1	
	ALG-1000	90 / 90	H	2	USI 28
	ALG-1004	90 / 90	H-181	1	USI 23
	ALG-1005	90 / 90	H-181	1	USI 21
	MN-015	90 / 90	variável conforme fornecedor recolhedor	1	
	MN-055	90 / 09	L-115	1	
	RE-22902	90 / 90	A-47	2	USI 8
	RE-22501	90 / 90	(L-169)/2	4	
	RE-22301	90 / 90	A-47	2	USI 13
	RE-22401	90 / 90	A-47	2	USI 14



JANELA DE CORRER
2 FOLHAS PARA 2 PLANOS
COM PERSIANA INTEGRADA MANUAL

COMPONENTES				
CROQUI	REF.	QDE.	DESCRIÇÃO	OBS.
	PCP-4832PL	24	Fixação marco/folha travessa	
	PCP-3995	$((A/350)+1)*2$	Fixa mata junta	
	PCP-3995	$((A/350)+1)*3$	Fixa ALG-1004/1005	
	VDA-22001	6	Vedação superior e inferior	Ver tabela de componentes
	DRN-22001	2	Dreno	Ver tabela de componentes
	CTF-0001	2	Contra fecho	Ver tabela de componentes
	FCH-0002	2	Fecho concha JANELA	Ver tabela de componentes
	TRV-22001	2	Lingueta fecho concha	Ver tabela de componentes
	GDE-22001	4	Guia da folha lateral	Ver tabela de componentes
	GDE-22002	4	Guia da folha mão de amigo	Ver tabela de componentes
	RLD-22001	4	Roldana da folha	Ver tabela de componentes
	BTE-0008	4	Batedeira da folha	Ver tabela de componentes
	VDA-22005	8	Espuma polietileno fechamento interno	Ver tabela de componentes
	VDA-0011	2	Lã pet isolamento dos rasgos das conchas	Ver tabela de componentes
	GPE-0006	2	Guia da Esteira	Ver tabela de componentes

JANELA DE CORRER 2 FOLHAS PARA 2 PLANOS

COM PERSIANA INTEGRADA MANUAL

COMPONENTES				
CROQUI	REF.	QDE.	DESCRIÇÃO	OBS.
	RCO-0001	1	Recolhedor manual janela	Ver tabela de componentes
	GCT-0003	1	Guia inferior da cinta	Ver tabela de componentes
	FPE-0001	4	Fixador da esteira	Ver tabela de componentes
	LPE-0001	2	Limitador da esteira	Ver tabela de componentes
	TMT-0005	2	Tampa da caixa	Ver tabela de componentes
	DAP-0001	2	Disco alinhador da esteira	Ver tabela de componentes
	PAC-0001	VAR	Palheta cega passo 41mm	Ver tabela de componentes
	PAV-0001	VAR	Palheta ventilada passo 41mm	Ver tabela de componentes

GUARNIÇÕES/ESCOVAS			
CROQUI	CÓDIGO	MEDIDA	DESCRIÇÃO
	QL-5375	2*A	Qlon de vedação
	GXT-1128	(2*L)+(4*A)	Gaxeta p/ vidro 6 mm
	GNC-0001	2*A	Mão de amigo
	ECV-0010 B	4*L	Escova 5X4 com barreira plastica
	EVC-0010 B	4*A	Escova 5X4 com barreira plastica
	EVC-0001 B	2*A	Escova 5X6 com barreira plastica
	GXT-1155	L	Gaxeta trava da tampa
	ECV-0012	3*L	Escova 5X12
	ECV-0004	L	Escova 5X7
	ECV-0006	4*A	Escova 5X8

VIDRO JANELA	
LARGURA	(L-185)/2
ALTURA	A-129

JANELA DE CORRER
2 FOLHAS PARA 2 PLANOS

COM PEITORIL FIXO E PERSIANA INTEGRADA MANUAL

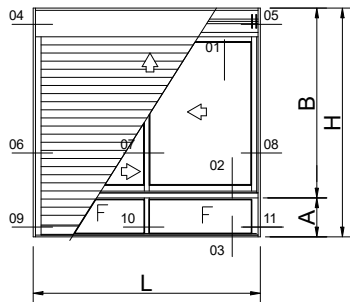

RE22-IJC201

VER COMBINAÇÕES DE PERFIS
NA SESSÃO: DETALHES

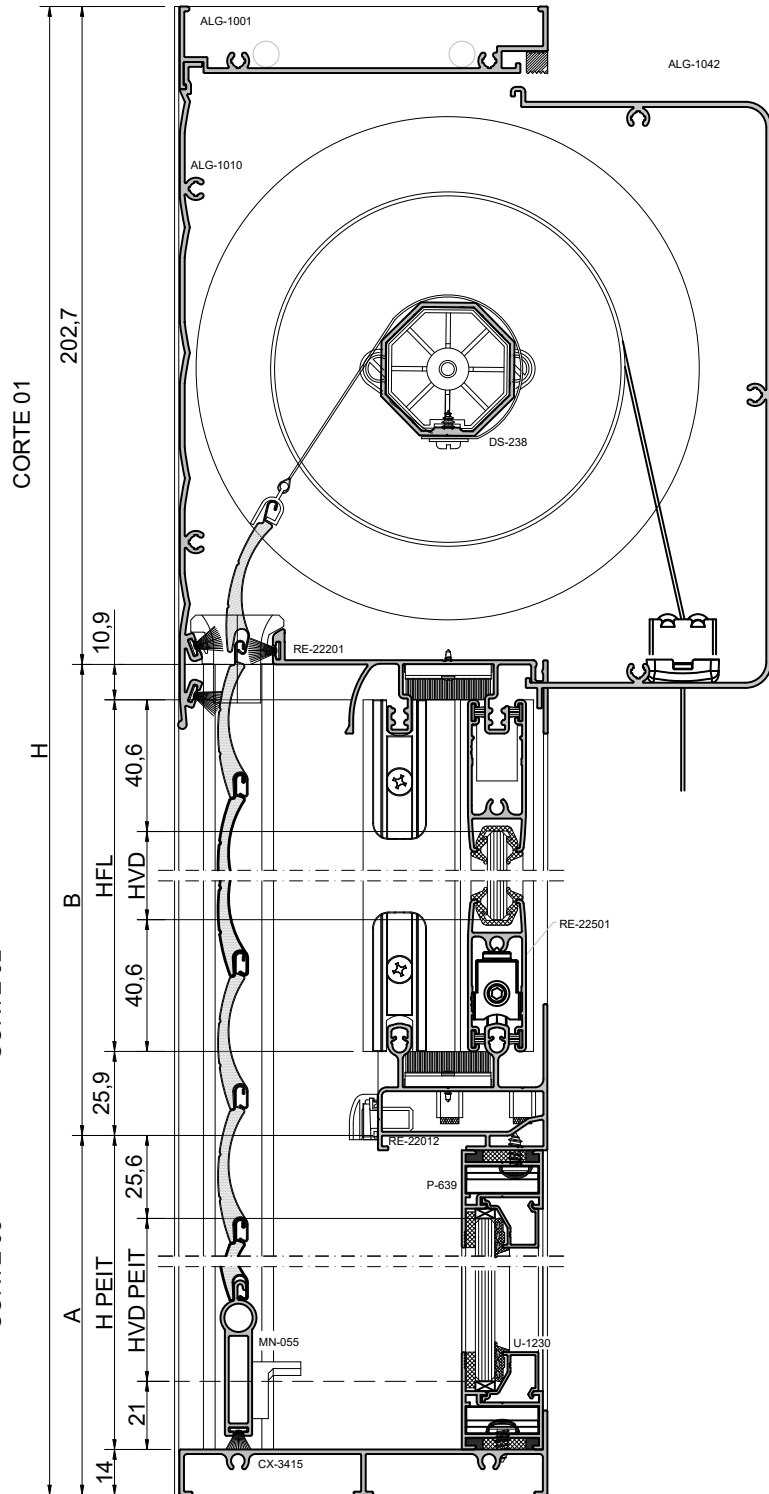

LADO EXTERNO

CORTE 01

CORTE 02

CORTE 03

ESC.: 1:2

JANELA DE CORRER

2 FOLHAS PARA 2 PLANOS

COM PEITORIL FIXO E PERSIANA INTEGRADA MANUAL

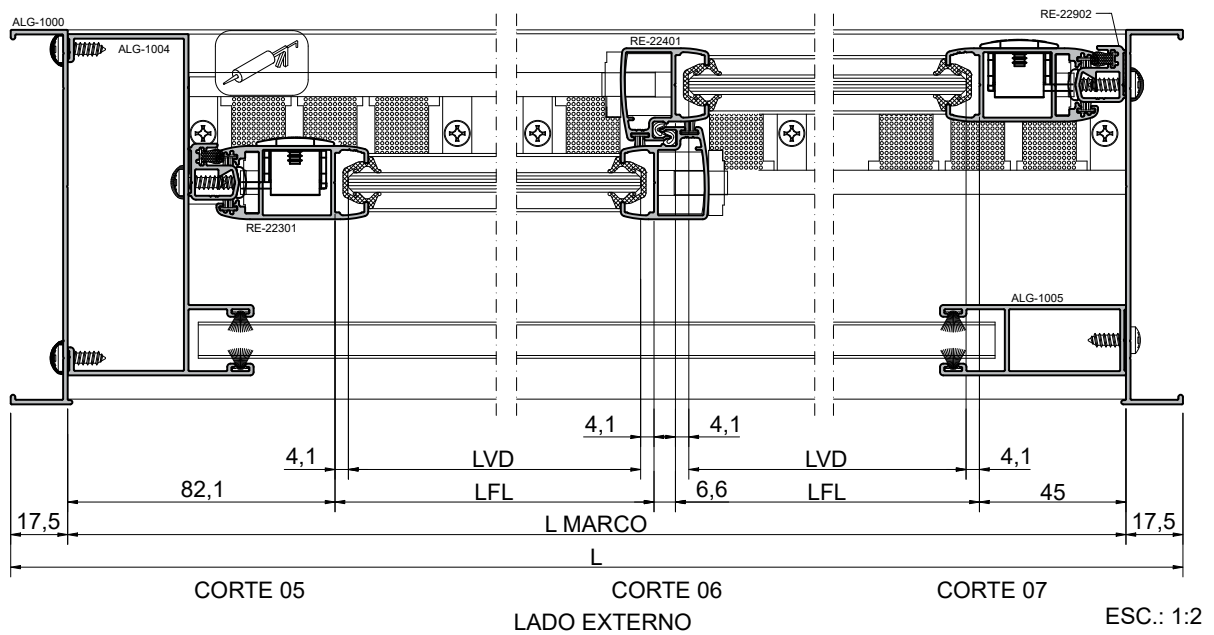
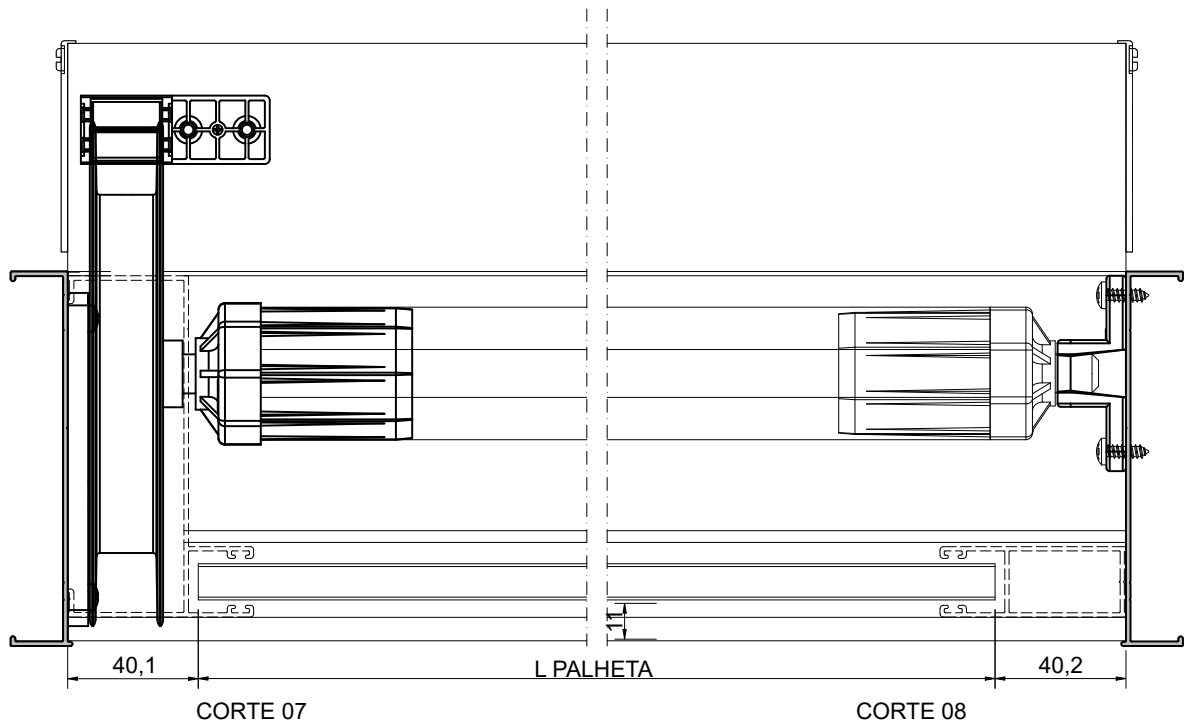

JANELA DE CORRER
2 FOLHAS PARA 2 PLANOS

COM PEITORIL FIXO E PERSIANA INTEGRADA MANUAL

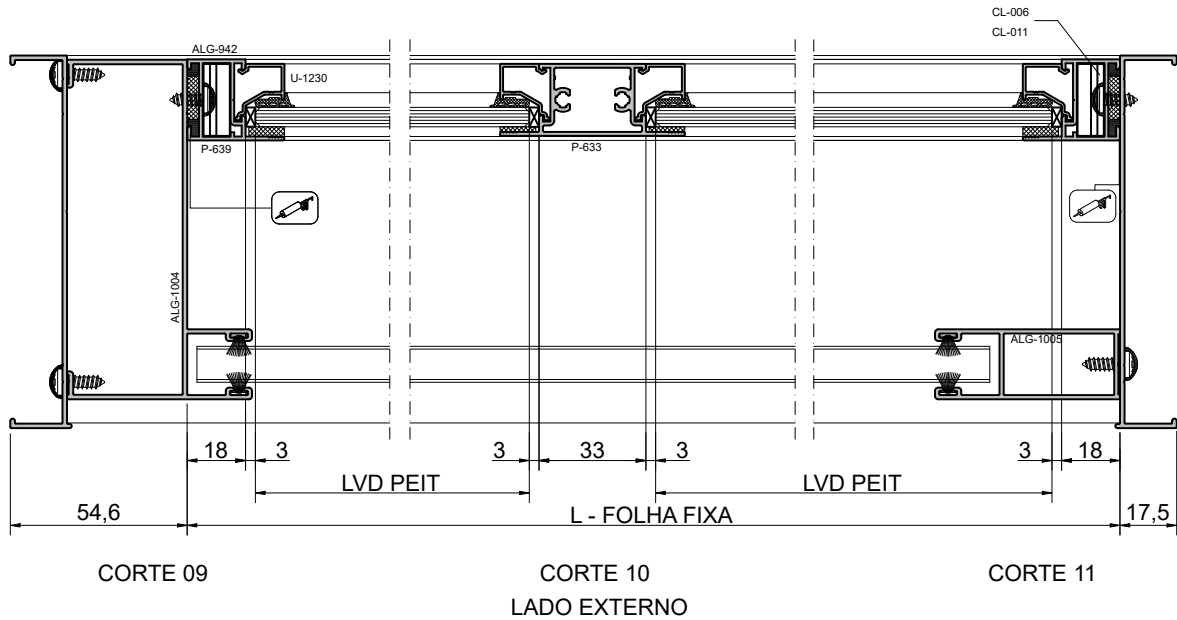

GUARNIÇÕES/ESCOVAS			
CROQUI	CÓDIGO	MEDIDA	DESCRIÇÃO
	QL-5375	2*B	Qlon de vedação
	GXT-1128	(2*L)+(4*B)	Gaxeta p/ vidro 6 mm
	GNC-0001	2*B	Mão de amigo
	ECV-0010B	2*L	Escova 5X4 com barreira plastica
	EVC-0010B	4*B	Escova 5X4 com barreira plastica
	EVC-0001B	2*B	Escova 5X6 com barreira plastica
	GXT-1155	L	Gaxeta trava da tampa
	ECV-0012	3*L	Escova 5X12
	ECV-0004	L	Escova 5X7
	ECV-0006	4*A	Escova 5X8
	GUA-259	(2*L)+(4*A)	Gaxeta de EPDM interna vidro 6mm











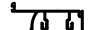

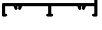



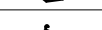
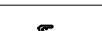

VIDRO JANELA	
LARGURA	(L-185)/2
ALTURA	B-118

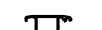
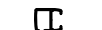
VIDRO PEITORIL	
LARGURA	(L-153)/2
ALTURA	A-61

ESC.: 1:2

JANELA DE CORRER 2 FOLHAS PARA 2 PLANOS

**COM PEITORIL FIXO E PERSIANA
INTEGRADA MANUAL**

PERFIS					
CROQUI	CÓDIGO	CORTE	TAMANHO	QD E.	USINAGEM
	ALG-1001	90 / 90	L-35	1	
	RE-22201	90 / 90	L-35	1	
	RE-22012	90 / 90	L-35	1	
	CX-3415	90 / 90	L-35	1	
	ALG-1007	90 / 90	L-35	1	
	ALG-1041	90 / 90	L-35	1	
	ALG-1000	90 / 90	H	2	USI 26
	ALG-1004	90 / 90	(A+B)-15	1	USI 22
	ALG-1005	90 / 90	(A+B)-15	1	USI 21
	DS-238	90 / 90	variável conforme fornecedor recolhedor	1	
	MN-055	90 / 09	L-115	1	
	RE-22902	90 / 90	B-37	2	USI 8
	RE-22501	90 / 90	(L-169)/2	4	
	RE-22301	90 / 90	B-37	2	USI 13
	RE-22401	90 / 90	B-37	2	USI 14
	P-639	45 / 45	L-35	2	
	P-639	45 / 45	A-18	2	
	P-633	90 / 90	A-54	1	
	U-1230	90 / 90	(L-141)/2	4	
	U-1230	90 / 90	A-78	4	
	CL-006	90 / 90	21	4	
	CL-011	90 / 90	21	8	

JANELA DE CORRER 2 FOLHAS PARA 2 PLANOS

COM PEITORIL FIXO E PERSIANA INTEGRADA MANUAL

COMPONENTES				
CROQUI	REF.	QDE.	DESCRIÇÃO	OBS.
	PCP-4832PL	28	Fixação marco/folha travessa	
	PCP-3995	$((B/350)+1)*2$	Fixa mata junta	
	PCP-3995	$((B/350)+1)*3$	Fixa ALG-1004/1005	
	PCP-3995	$((2*(L+A))/350)+1$	Fixa peitoril	
	VDA-22001	6	Vedação superior e inferior	Ver tabela de componentes
	DRN-22001	2	Dreno	Ver tabela de componentes
	CTF-0001	2	Contra fecho	Ver tabela de componentes
	FCH-0002	2	Fecho concha JANELA	Ver tabela de componentes
	TRV-22001	2	Lingueta fecho concha	Ver tabela de componentes
	GDE-22001	4	Guia da folha lateral	Ver tabela de componentes
	GDE-22002	4	Guia da folha mão de amigo	Ver tabela de componentes
	RLD-22001	4	Roldana da folha	Ver tabela de componentes
	BTE-0008	4	Batedeira da folha	Ver tabela de componentes
	VDA-22005	8	Espuma polietileno fechamento interno	Ver tabela de componentes
	VDA-0011	2	Lã pet isolamento dos rasgos das conchas	Ver tabela de componentes
	P020010	16	Calço do vidro EPDM 6x3x50	Calço do vidro peitoril
	ESP-11x4	$(2*(L+A))$	Espuma polietileno 11x4	Vedação quadro fixo
	GUA-258	$(2*(L+A))$	Espuma polietileno 11x4	Esp. vidro 6 mm
	GUA-171	$2*A$	Espuma polietileno 11x3	Esp. vidro 6 mm coluna
	GPE-0006	2	Guia da Esteira	Ver tabela de componentes

JANELA DE CORRER 2 FOLHAS PARA 2 PLANOS

COM PEITORIL FIXO E PERSIANA INTEGRADA MANUAL

COMPONENTES				
CROQUI	REF.	QDE.	DESCRIÇÃO	OBS.
	RCO-0001	1	Recolhedor manual janela	Ver tabela de componentes
	GCT-0003	1	Guia inferior da cinta	Ver tabela de componentes
	FPE-0001	4	Fixador da esteira	Ver tabela de componentes
	LPE-0001	2	Limitador da esteira	Ver tabela de componentes
	TMT-0005	2	Tampa da caixa	Ver tabela de componentes
	DAP-0001	2	Disco alinhador da esteira	Ver tabela de componentes
	PAC-0001	VAR	Palheta cega passo 41mm	Ver tabela de componentes
	PAV-0001	VAR	Palheta ventilada passo 41mm	Ver tabela de componentes

JANELA DE CORRER
2 FOLHAS PARA 2 PLANOS

COM PERSIANA INTEGRADA
COM MOTOR

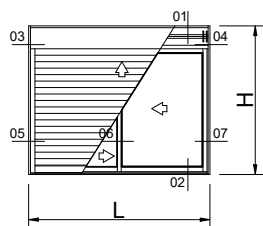

RE22-IJC200

VER COMBINAÇÕES DE PERFIS
 NA SESSÃO: DETALHES

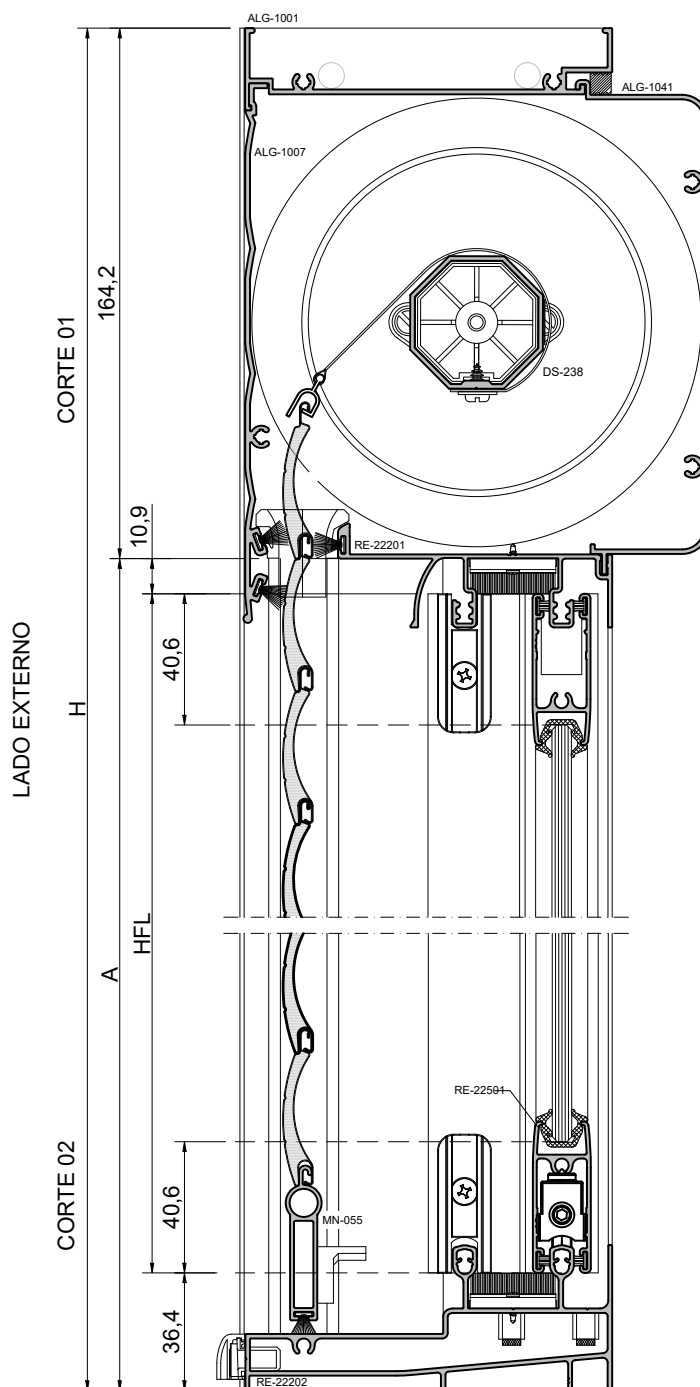

ESC.: 1:2

JANELA DE CORRER





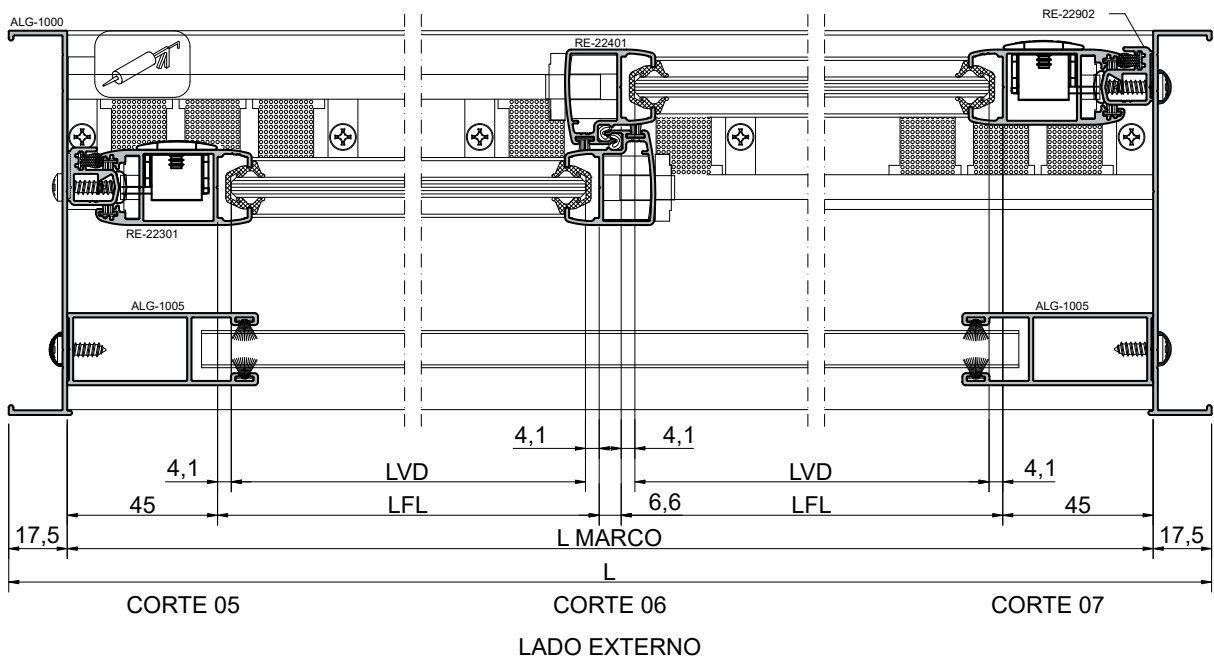
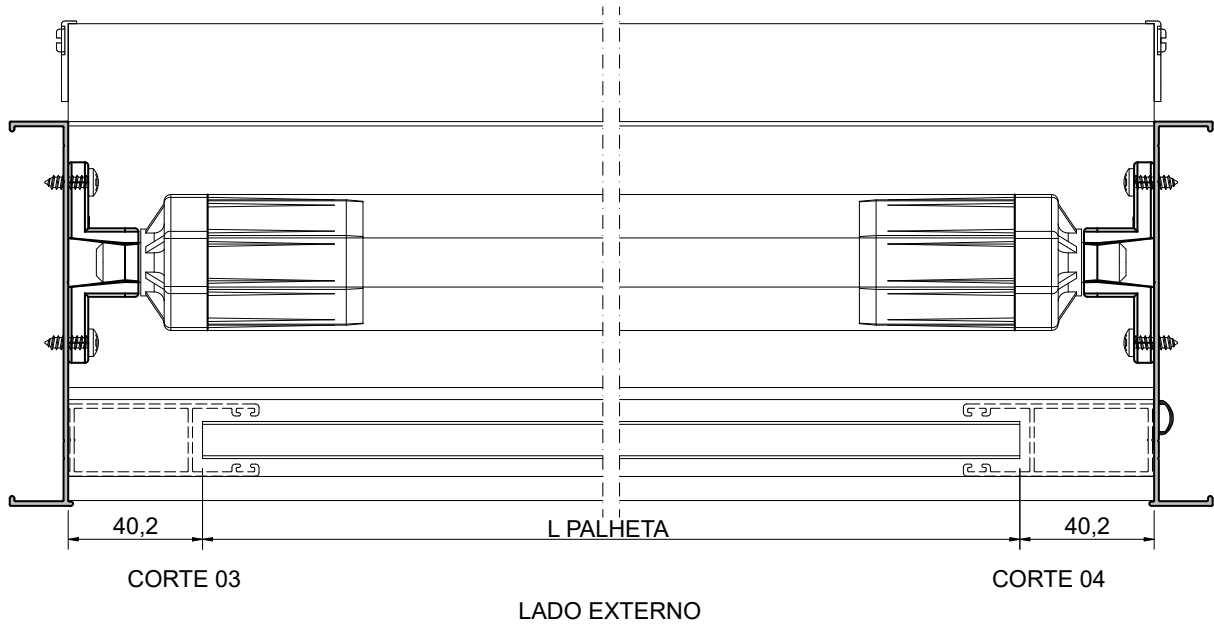



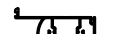

2 FOLHAS PARA 2 PLANOS

COM PERSIANA INTEGRADA
COM MOTOR

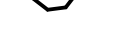

ESC.: 1:2

JANELA DE CORRER
2 FOLHAS PARA 2 PLANOS
COM PERSIANA INTEGRADA
COM MOTOR

PERFIS					
CROQUI	CÓDIGO	CORTE	TAMANHO	QDE.	USINAGEM
	ALG-1001	90 / 90	L-35	1	
	RE-22201	90 / 90	L-35	1	
	RE-22202	90 / 90	L-35	1	
	ALG-1007	90 / 90	L-35	1	
	ALG-1041	90 / 90	L-35	1	
	ALG-1000	90 / 90	H	2	USI 24
	ALG-1005	90 / 90	A-18	2	USI 21
	DS-238	90 / 90	variável conforme fornecedor recolhedor	1	
	MN-055	90 / 09	L-115	1	
	RE-22902	90 / 90	A-47	2	USI 8
	RE-22501	90 / 90	(L-132)/2	4	
	RE-22301	90 / 90	A-47	2	USI 13
	RE-22401	90 / 90	A-47	2	USI 14







JANELA DE CORRER 2 FOLHAS PARA 2 PLANOS

COM PERSIANA INTEGRADA COM MOTOR

COMPONENTES				
CROQUI	REF.	QDE.	DESCRIÇÃO	OBS.
	PCP-4832PL	24	Fixação marco/folha travessa	
	PCP-3995	$((A/350)+1)*2$	Fixa mata junta	
	PCP-3995	$((A/350)+1)*2$	Fixa ALG-1004/1005	
	VDA-22001	6	Vedação superior e inferior	Ver tabela de componentes
	DRN-22001	2	Dreno	Ver tabela de componentes
	CTF-0001	2	Contra fecho	Ver tabela de componentes
	FCH-0002	2	Fecho concha JANELA	Ver tabela de componentes
	TRV-22001	2	Lingueta fecho concha	Ver tabela de componentes
	GDE-22001	4	Guia da folha lateral	Ver tabela de componentes
	GDE-22002	4	Guia da folha mão de amigo	Ver tabela de componentes
	RLD-22001	4	Roldana da folha	Ver tabela de componentes
	BTE-0008	4	Batedeira da folha	Ver tabela de componentes
	VDA-22005	12	Espuma polietileno fechamento interno	Ver tabela de componentes
	VDA-0011	2	Lã pet isolamento os calços de vedação	Ver tabela de componentes
	GPE-0006	2	Guia da Esteira	Ver tabela de componentes

JANELA DE CORRER
2 FOLHAS PARA 2 PLANOS

COM PERSIANA INTEGRADA
COM MOTOR

COMPONENTES				
CROQUI	REF.	QDE.	DESCRIÇÃO	OBS.
	FPE-0001	4	Fixador da esteira	Ver tabela de componentes
	LPE-0001	2	Limitador da esteira	Ver tabela de componentes
	TMT-0005	2	Tampa da caixa	Ver tabela de componentes
	DAP-0001	2	Disco alinhador da esteira	Ver tabela de componentes
	PAC-0001	VAR	Palheta cega passo 41mm	Ver tabela de componentes
	PAV-0001	VAR	Palheta ventilada passo 41mm	Ver tabela de componentes

GUARNIÇÕES/ESCOVAS			
CROQUI	CÓDIGO	MEDIDA	DESCRIÇÃO
	QL-5375	2*A	Qlon de vedação
	GXT-1128	(2*L)+(4*A)	Gaxeta p/ vidro 6 mm
	GNC-0001	2*A	Mão de amigo
	ECV-0010B	4*L	Escova 5X4 com barreira plastica
	EVC-0010B	4*A	Escova 5X4 com barreira plastica
	EVC-0001B	2*A	Escova 5X6 com barreira plastica
	GXT-1155	L	Gaxeta trava da tampa
	ECV-0012	3*L	Escova 5X12
	ECV-0004	L	Escova 5X7
	ECV-0006	4*A	Escova 5X8

VIDRO JANELA	
LARGURA	(L-148)/2
ALTURA	A-128

JANELA DE CORRER 2 FOLHAS PARA 2 PLANOS

COM PERSIANA INTEGRADA COM MOTOR

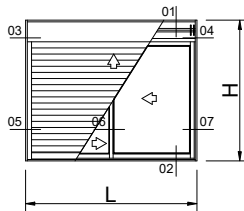

RE22-IJC200

VER COMBINAÇÕES DE PERFIS
NA SESSÃO: DETALHES

CORTE 01

LADO EXTERNO

CORTE 02

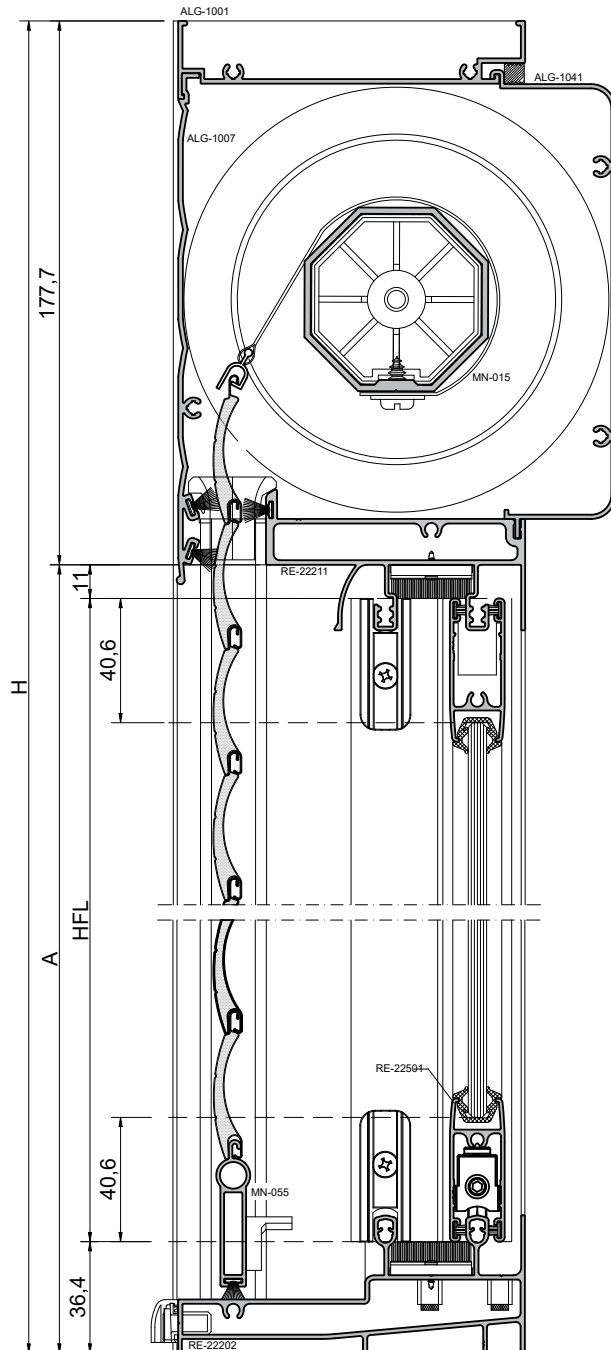

ESC.: 1:2

JANELA DE CORRER
2 FOLHAS PARA 2 PLANOS



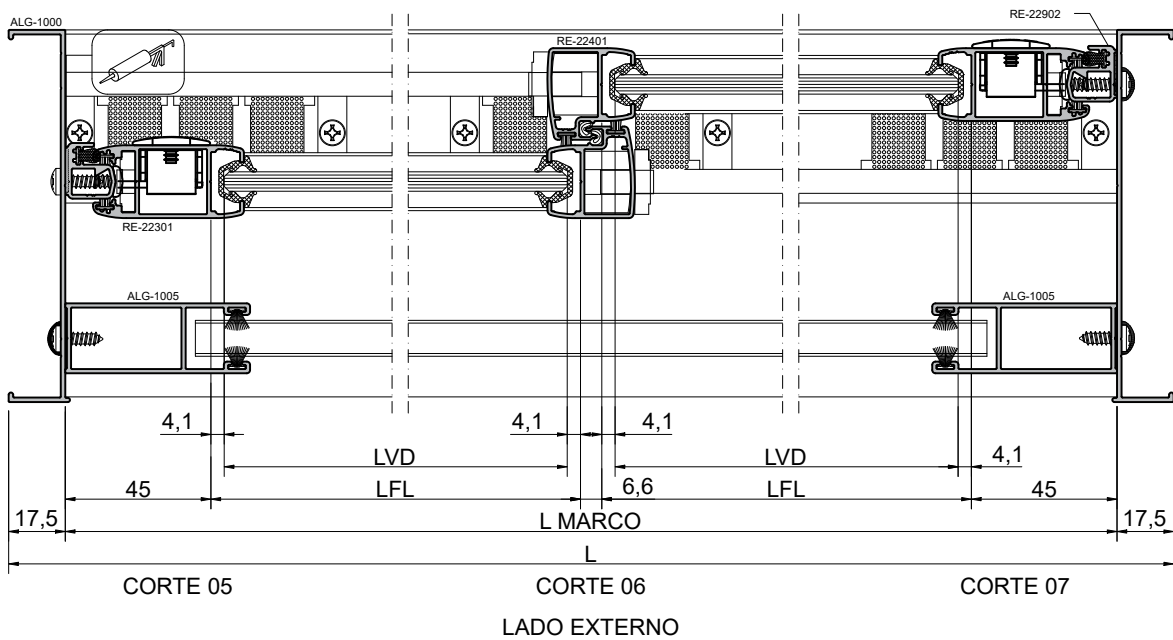
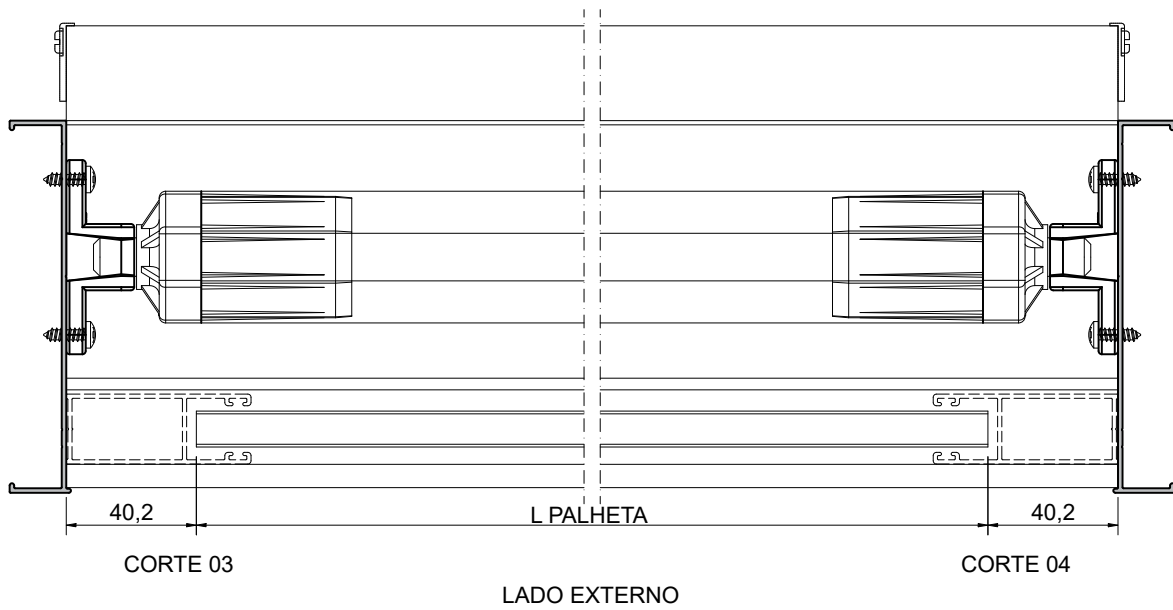





COM PERSIANA INTEGRADA
COM MOTOR

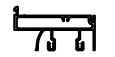

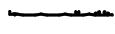
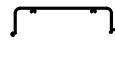
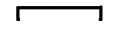
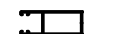
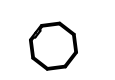
ESC.: 1:2

JANELA DE CORRER 2 FOLHAS PARA 2 PLANOS

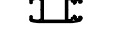













**COM PERSIANA INTEGRADA
COM MOTOR**

PERFIS					
CROQUI	CÓDIGO	CORTE	TAMANHO	QDE.	USINAGEM
	ALG-1001	90 / 90	L-35	1	
	RE-22211	90 / 90	L-35	1	
	RE-22202	90 / 90	L-35	1	
	ALG-1007	90 / 90	L-35	1	
	ALG-1041	90 / 90	L-35	1	
	ALG-1000	90 / 90	H	2	USI 28
	ALG-1005	90 / 90	H-181	2	USI 21
	MN-015	90 / 90	variável conforme fornecedor recolhedor	1	
	MN-055	90 / 09	L-115	1	
	RE-22902	90 / 90	A-47	2	USI 8
	RE-22501	90 / 90	(L-132)/2	4	
	RE-22301	90 / 90	A-47	2	USI 13
	RE-22401	90 / 90	A-47	2	USI 14

JANELA DE CORRER







2 FOLHAS PARA 2 PLANOS











COM PERSIANA INTEGRADA COM MOTOR

COMPONENTES				
CROQUI	REF.	QDE.	DESCRIÇÃO	OBS.
	PCP-4832PL	24	Fixação marco/folha travessa	
	PCP-3995	$((A/350)+1)*2$	Fixa mata junta	
	PCP-3995	$((A/350)+1)*2$	Fixa ALG-1004/1005	
	VDA-22001	6	Vedação superior e inferior	Ver tabela de componentes
	DRN-22001	2	Dreno	Ver tabela de componentes
	CTF-0001	2	Contra fecho	Ver tabela de componentes
	FCH-0002	2	Fecho concha JANELA	Ver tabela de componentes
	TRV-22001	2	Lingueta fecho concha	Ver tabela de componentes
	GDE-22001	4	Guia da folha lateral	Ver tabela de componentes
	GDE-22002	4	Guia da folha mão de amigo	Ver tabela de componentes
	RLD-22001	4	Roldana da folha	Ver tabela de componentes
	BTE-0008	4	Batedeira da folha	Ver tabela de componentes
	VDA-22005	12	Espuma polietileno fechamento interno	Ver tabela de componentes
	VDA-0011	2	Lã pet isolamento os calços de vedação	Ver tabela de componentes
	GPE-0006	2	Guia da Esteira	Ver tabela de componentes

JANELA DE CORRER 2 FOLHAS PARA 2 PLANOS

**COM PERSIANA INTEGRADA
COM MOTOR**

COMPONENTES				
CROQUI	REF.	QDE.	DESCRIÇÃO	OBS.
	FPE-0001	4	Fixador da esteira	Ver tabela de componentes
	LPE-0001	2	Limitador da esteira	Ver tabela de componentes
	TMT-0005	2	Tampa da caixa	Ver tabela de componentes
	DAP-0001	2	Disco alinhador da esteira	Ver tabela de componentes
	PAC-0001	VAR	Palheta cega passo 41mm	Ver tabela de componentes
	PAV-0001	VAR	Palheta ventilada passo 41mm	Ver tabela de componentes

GUARNIÇÕES/ESCOVAS			
CROQUI	CÓDIGO	MEDIDA	DESCRIÇÃO
	QL-5375	2*A	Qlon de vedação
	GXT-1128	(2*L)+(4*A)	Gaxeta p/ vidro 6 mm
	GNC-0001	2*A	Mão de amigo
	ECV-0010B	4*L	Escova 5X4 com barreira plastica
	EVC-0010B	4*A	Escova 5X4 com barreira plastica
	EVC-0001B	2*A	Escova 5X6 com barreira plastica
	GXT-1155	L	Gaxeta trava da tampa
	ECV-0012	3*L	Escova 5X12
	ECV-0004	L	Escova 5X7
	ECV-0006	4*A	Escova 5X8

VIDRO JANELA	
LARGURA	(L-148)/2
ALTURA	A-129

JANELA DE CORRER
2 FOLHAS PARA 2 PLANOS

COM PEITORIL FIXO E PERSIANA INTEGRADA MANUAL COM MOTOR

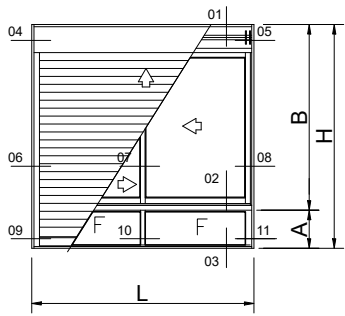

RE22-IJC201

CORTE 01

VER COMBINAÇÕES DE PERFIS
 NA SESSÃO: DETALHES

LADO EXTERNO

CORTE 02

CORTE 03

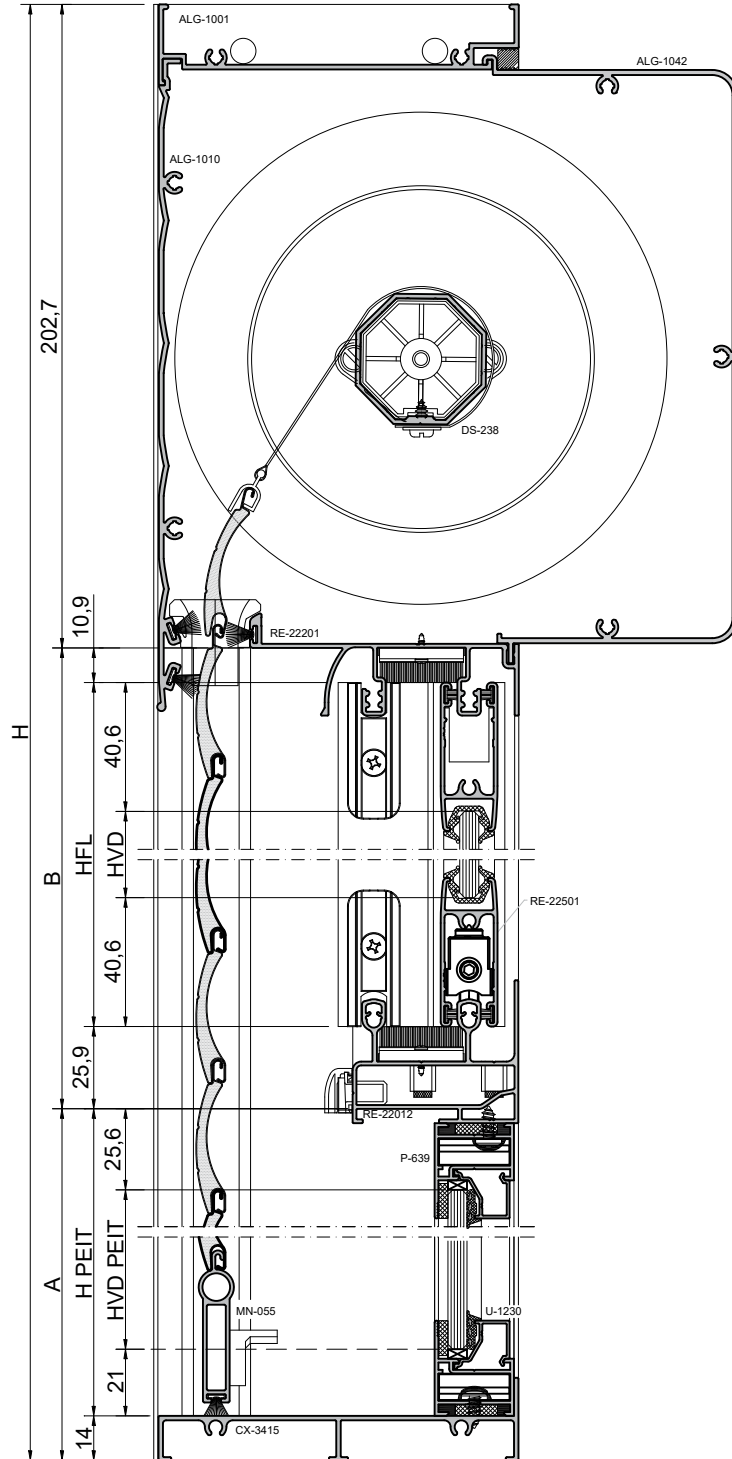

ESC.: 1:2

JANELA DE CORRER

2 FOLHAS PARA 2 PLANOS

COM PEITORIL FIXO E PERSIANA INTEGRADA MANUAL COM MOTOR

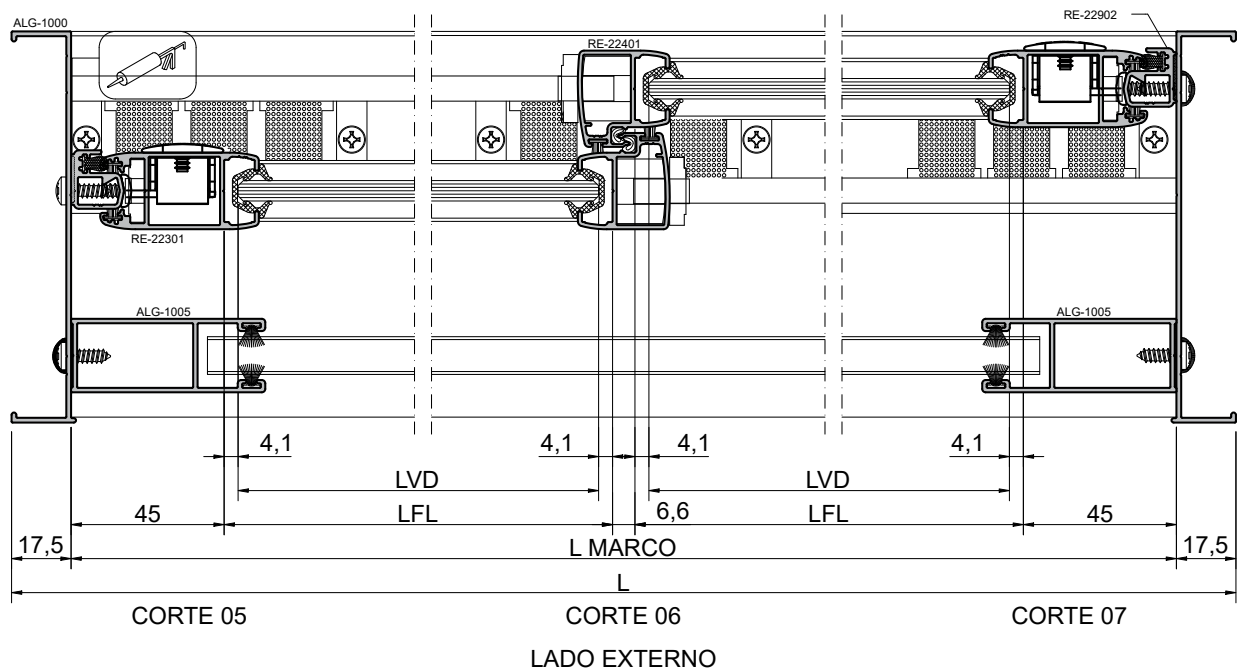
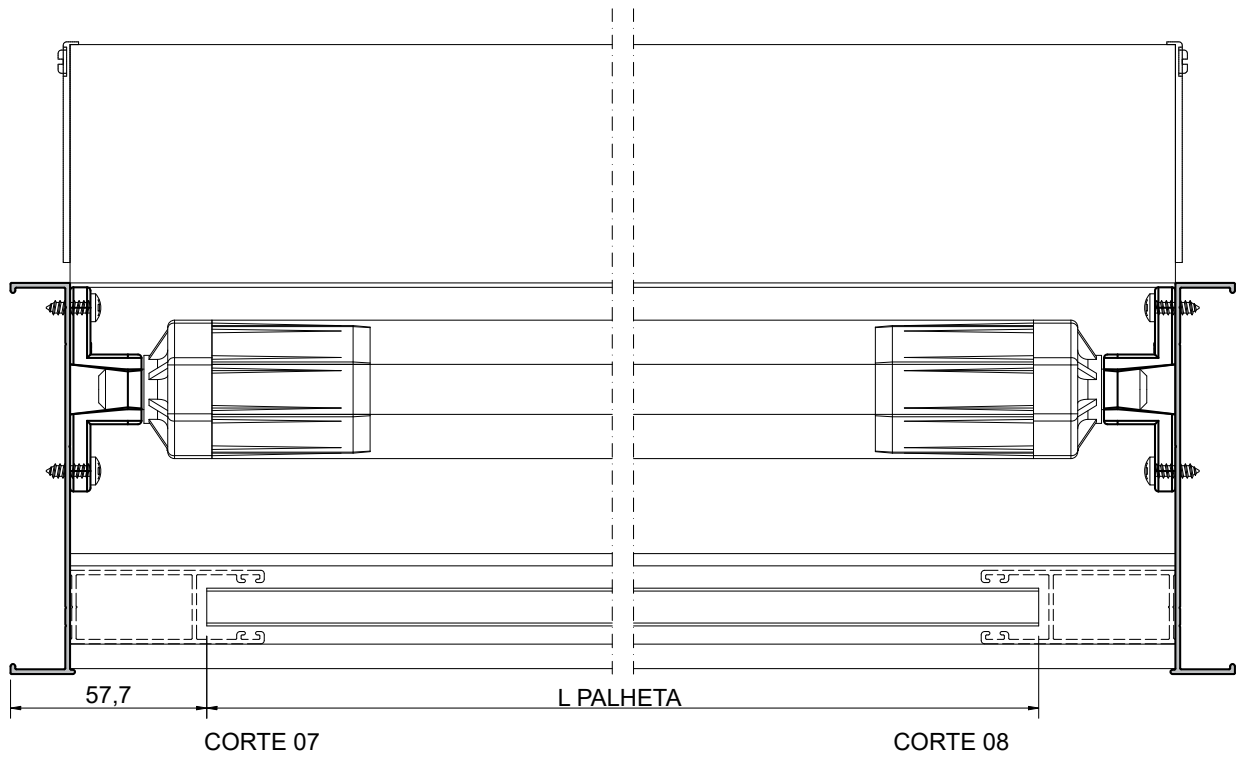

ESC.: 1:2

JANELA DE CORRER
2 FOLHAS PARA 2 PLANOS

COM PEITORIL FIXO E PERSIANA INTEGRADA MANUAL COM MOTOR

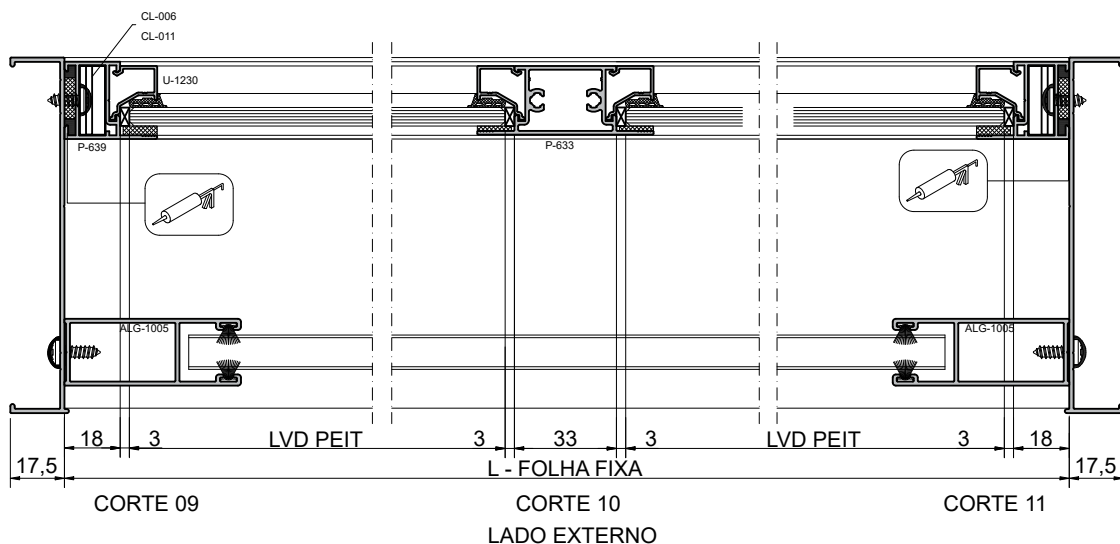

GUARNIÇÕES/ESCOVAS			
CROQUI	CÓDIGO	MEDIDA	DESCRIÇÃO
	QL-5375	2*B	Qlon de vedação
	GXT-1128	(2*L)+(4*B)	Gaxeta p/ vidro 6 mm
	GNC-0001	2*B	Mão de amigo
	ECV-0010B	4*L	Escova 5X4 com barreira plastica
	EVC-0010B	4*B	Escova 5X4 com barreira plastica
	EVC-0001B	2*B	Escova 5X6 com barreira plastica
	GXT-1155	L	Gaxeta trava da tampa
	ECV-0012	3*L	Escova 5X12
	ECV-0004	L	Escova 5X7
	ECV-0006	4*A	Escova 5X8
	GUA-259	(2*L)+(4*A)	Gaxeta de EPDM interna vidro 6mm













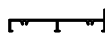







VIDRO JANELA	
LARGURA	(L-148)/2
ALTURA	B-118

VIDRO PEITORIL	
LARGURA	(L-116)/2
ALTURA	A-61

ESC.: 1:2





















JANELA DE CORRER 2 FOLHAS PARA 2 PLANOS

**COM PEITORIL FIXO E PERSIANA
INTEGRADA MANUAL COM MOTOR**

PERFIS					
CROQUI	CÓDIGO	CORTE	TAMANHO	QDE.	USINAGEM
	ALG-1001	90 / 90	L-35	1	
	RE-22201	90 / 90	L-35	1	
	RE-22012	90 / 90	L-35	1	
	CX-3415	90 / 90	L-35	1	
	ALG-1007	90 / 90	L-35	1	
	ALG-1042	90 / 90	L-35	1	
	ALG-1000	90 / 90	H	2	USI 26
	ALG-1005	90 / 90	(A+B)-15	2	USI 21
	DS-238	90 / 90	variável conforme fornecedor recolhedor	1	
	MN-055	90 / 09	L-115	1	
	RE-22902	90 / 90	B-37	2	USI 8
	RE-22501	90 / 90	(L-132)/2	4	
	RE-22301	90 / 90	B-37	2	USI 13
	RE-22401	90 / 90	B-37	2	USI 14
	P-639	45 / 45	L-35	2	
	P-639	45 / 45	A-19	2	
	P-633	90 / 90	A-54	1	
	U-1230	90 / 90	(L-104)/2	4	
	U-1230	90 / 90	A-79	4	
	CL-006	90 / 90	21	4	
	CL-011	90 / 90	21	8	





JANELA DE CORRER 2 FOLHAS PARA 2 PLANOS

**COM PEITORIL FIXO E PERSIANA
INTEGRADA MANUAL COM MOTOR**

COMPONENTES				
CROQUI	REF.	QDE.	DESCRIÇÃO	OBS.
	PCP-4832PL	28	Fixação marco/folha travessa	
	PCP-3995	$((B/350)+1)*2$	Fixa mata junta	
	PCP-3995	$((B/350)+1)*2$	Fixa ALG-1004/1005	
	PCP-3995	$((2*(L+A))/350)+1$	Fixa peitoril	
	VDA-22001	6	Vedação superior e inferior	Ver tabela de componentes
	DRN-22001	2	Dreno	Ver tabela de componentes
	CTF-0001	2	Contra fecho	Ver tabela de componentes
	FCH-0002	2	Fecho concha JANELA	Ver tabela de componentes
	TRV-22001	2	Lingueta fecho concha	Ver tabela de componentes
	GDE-22001	4	Guia da folha lateral	Ver tabela de componentes
	GDE-22002	4	Guia da folha mão de amigo	Ver tabela de componentes
	RLD-22001	4	Roldana da folha	Ver tabela de componentes
	BTE-0008	4	Batedeira da folha	Ver tabela de componentes
	VDA-22005	8	Espuma polietileno fechamento interno	Ver tabela de componentes
	VDA-0011	2	Lã pet isolamento dos rasgos das conchas	Ver tabela de componentes
	P020010	16	Calço do vidro EPDM 6x3x50	Calço do vidro peitoril
	ESP-11x4	$(2*(L+A))$	Espuma polietileno 11x4	Vedação quadro fixo
	GUA-258	$(2*(L+A))$	Espuma polietileno 11x4	Esp. vidro 6 mm
	GUA-171	$2*A$	Espuma polietileno 11x3	Esp. vidro 6 mm coluna
	GPE-0006	2	Guia da Esteira	Ver tabela de componentes

JANELA DE CORRER 2 FOLHAS PARA 2 PLANOS

**COM PEITORIL FIXO E PERSIANA
INTEGRADA MANUAL COM MOTOR**

COMPONENTES				
CROQUI	REF.	QDE.	DESCRIÇÃO	OBS.
	FPE-0001	4	Fixador da esteira	Ver tabela de componentes
	LPE-0001	2	Limitador da esteira	Ver tabela de componentes
	TMT-0007	2	Tampa da caixa	Ver tabela de componentes
	DAP-0001	2	Disco alinhador da esteira	Ver tabela de componentes
	PAC-0001	VAR	Palheta cega passo 41mm	Ver tabela de componentes
	PAV-0001	VAR	Palheta ventilada passo 41mm	Ver tabela de componentes

PORTA DE CORRER
2 FOLHAS PARA 2 PLANOS

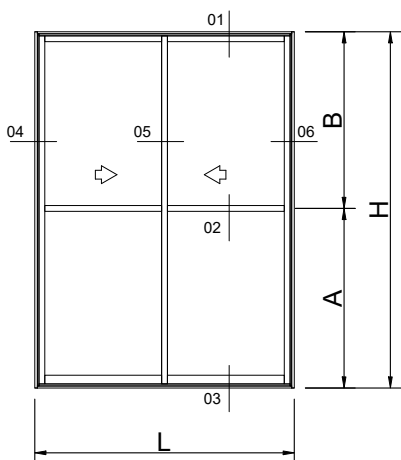

RE22-PCR200

VER COMBINAÇÕES DE PERFIS
NA SESSÃO: DETALHES

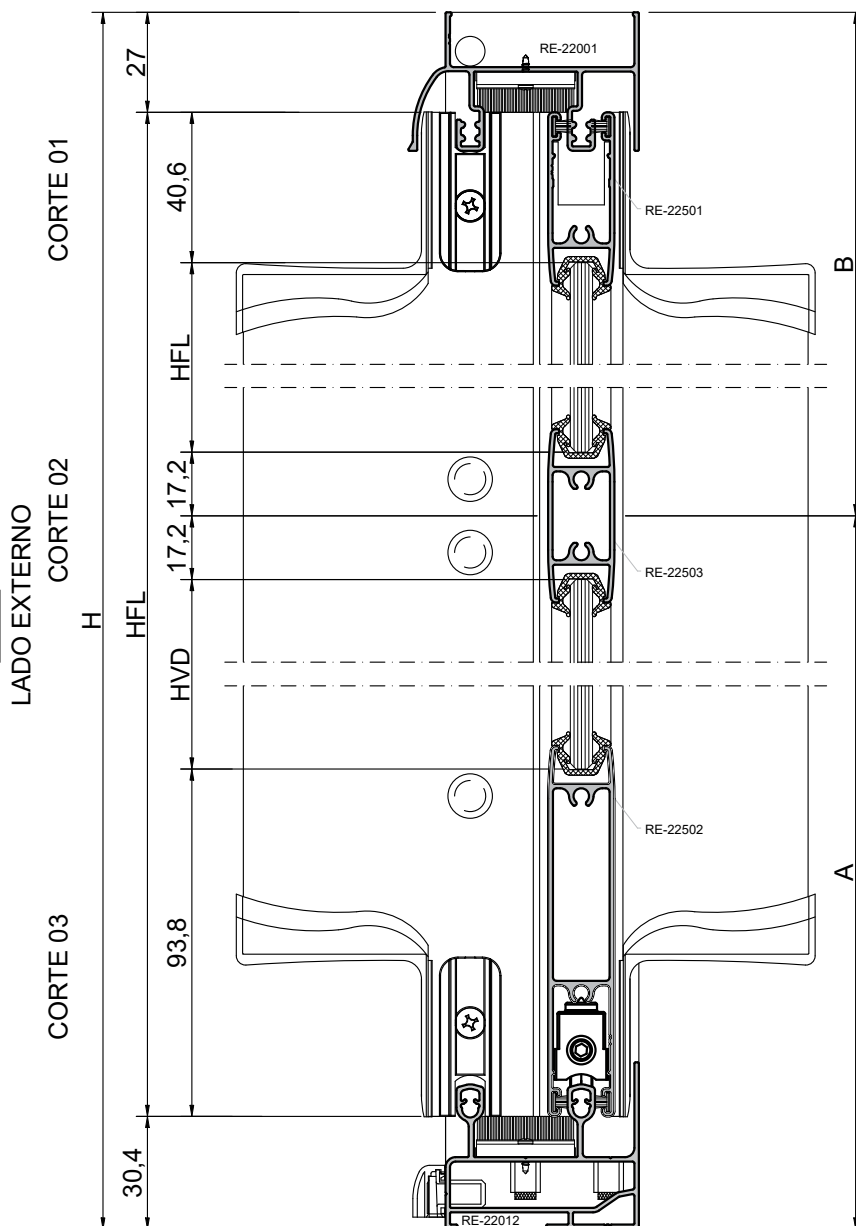

ESC.: 1:2





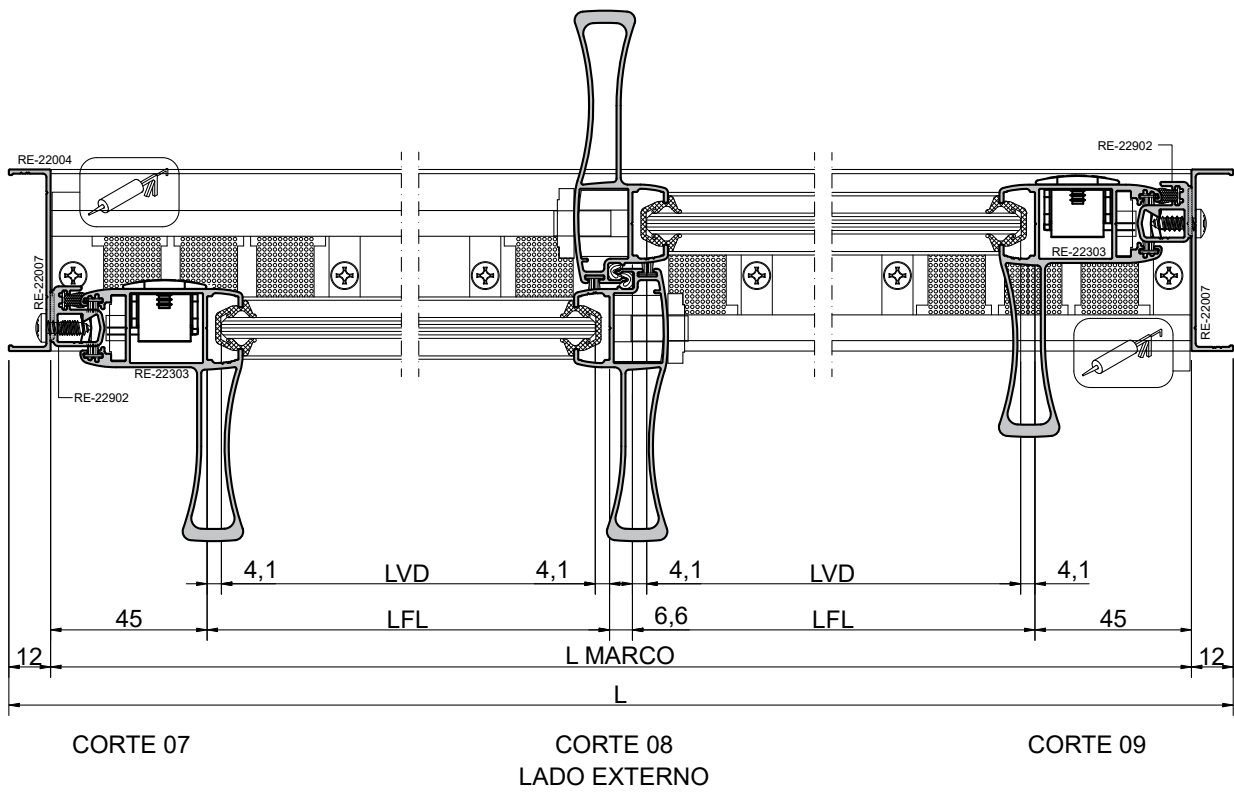



PORTA DE CORRER







2 FOLHAS PARA 2 PLANOS



ESC.: 1:2

PORTA DE CORRER
2 FOLHAS PARA 2 PLANOS

PERFIS					
CROQUI	CÓDIGO	CORTE	TAMANHO	QDE.	USINAGEM
	RE-22001	90 / 90	L-24	1	
	RE-22012	90 / 90	L-24	1	USI 11
	RE-22007	90 / 90	H	2	USI 1
	RE-22902	90 / 90	H-57	2	USI 8
	RE-22501	90 / 90	(L-121) / 2	2	
	RE-22503	90 / 90	(L-121) / 2	2	
	RE-22501	90 / 90	(L-121) / 2	2	
	RE-22303	90 / 90	H-57	2	USI 13
	RE-22403	90 / 90	H-57	2	USI 14

GUARNIÇÕES/ESCOVAS			
CROQUI	CÓDIGO	MEDIDA	DESCRIÇÃO
	QL-5375	2*H	Qlon de vedação
	GXT-1128	(4*L)+(4*H)	Gaxeta p/ vidro 6 mm
	GNC-0001	2*H	Mão de amigo
	ECV-0010B	4*L	Escova 5X4 com barreira plastica
	EVC-0010B	6*H	Escova 5X4 com barreira plastica
	EVC-0001B	2*H	Escova 5X6 com barreira plastica

VIDRO PORTA	
LARGURA	(L-137)/2
ALTURA	A-141
ALTURA	B-85

PORTA DE CORRER 2 FOLHAS PARA 2 PLANOS

COMPONENTES				
CROQUI	REF.	QDE.	DESCRIÇÃO	OBS.
	PCP-4832PL	28	Fixação do marco/folha	
	PCP-3995	$((H/350)+1)*2$	Fixa mata junta	
	VDA-22001	6	Vedação superior e inferior	Ver tabela de componentes
	DRN-22001	2	Dreno	Ver tabela de componentes
	CTF-0001	2	Contra fecho	Ver tabela de componentes
	FCH-0002	2	Fecho concha PORTA	Ver tabela de componentes
	TRV-22001	2	Lingueta fecho concha	Ver tabela de componentes
	GDE-22001	4	Guia da folha lateral	Ver tabela de componentes
	GDE-22002	4	Guia da folha mão de amigo	Ver tabela de componentes
	RLD-22002	4	Roldana da folha	Ver tabela de componentes
	BTE-0001	4	Batedeira da folha	Ver tabela de componentes
	TMT-0021	8	Tampa montante	Ver tabela de componentes
	TMT-0004	12	Tampa furo	Ver tabela de componentes
	VDA-22005	8	Espuma polietileno fechamento interno	Ver tabela de componentes
	VDA-0011	2	Lã pet isolamento dos rasgos das conchas	Ver tabela de componentes

PORTA DE CORRER
2 FOLHAS PARA 2 PLANOS

MARCO LATERAL COM MATA-JUNTA SOLIDARIZADOS

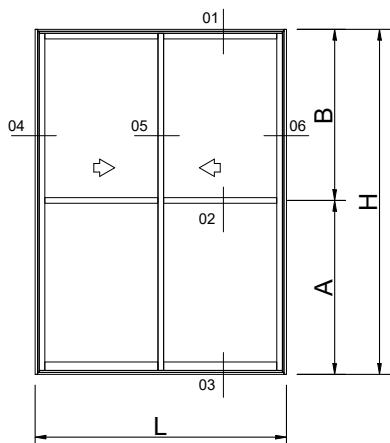

RE22-PCR200

VER COMBINAÇÕES DE PERFIS
NA SESSÃO: DETALHES

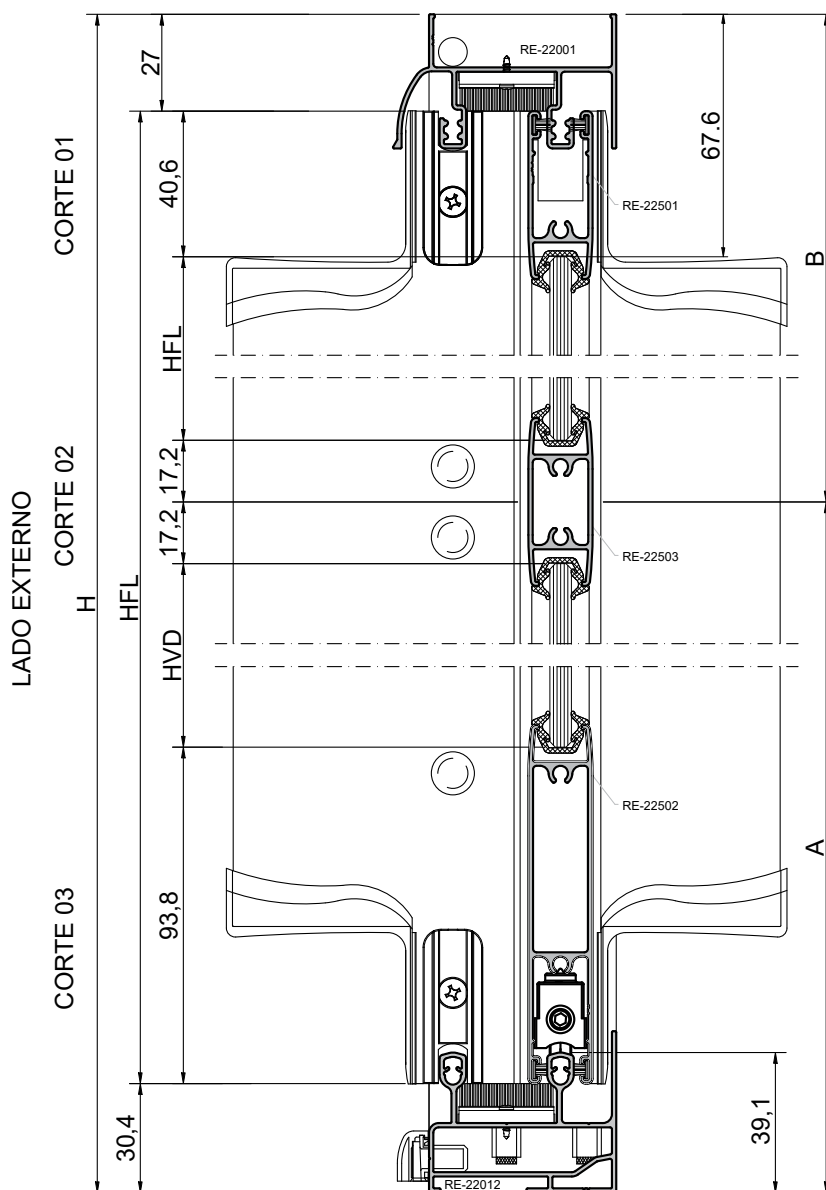

ESC.: 1:2

JANELA DE CORRER

2 FOLHAS PARA 2 PLANOS

MARCO LATERAL COM MATA-JUNTA SOLIDARIZADOS

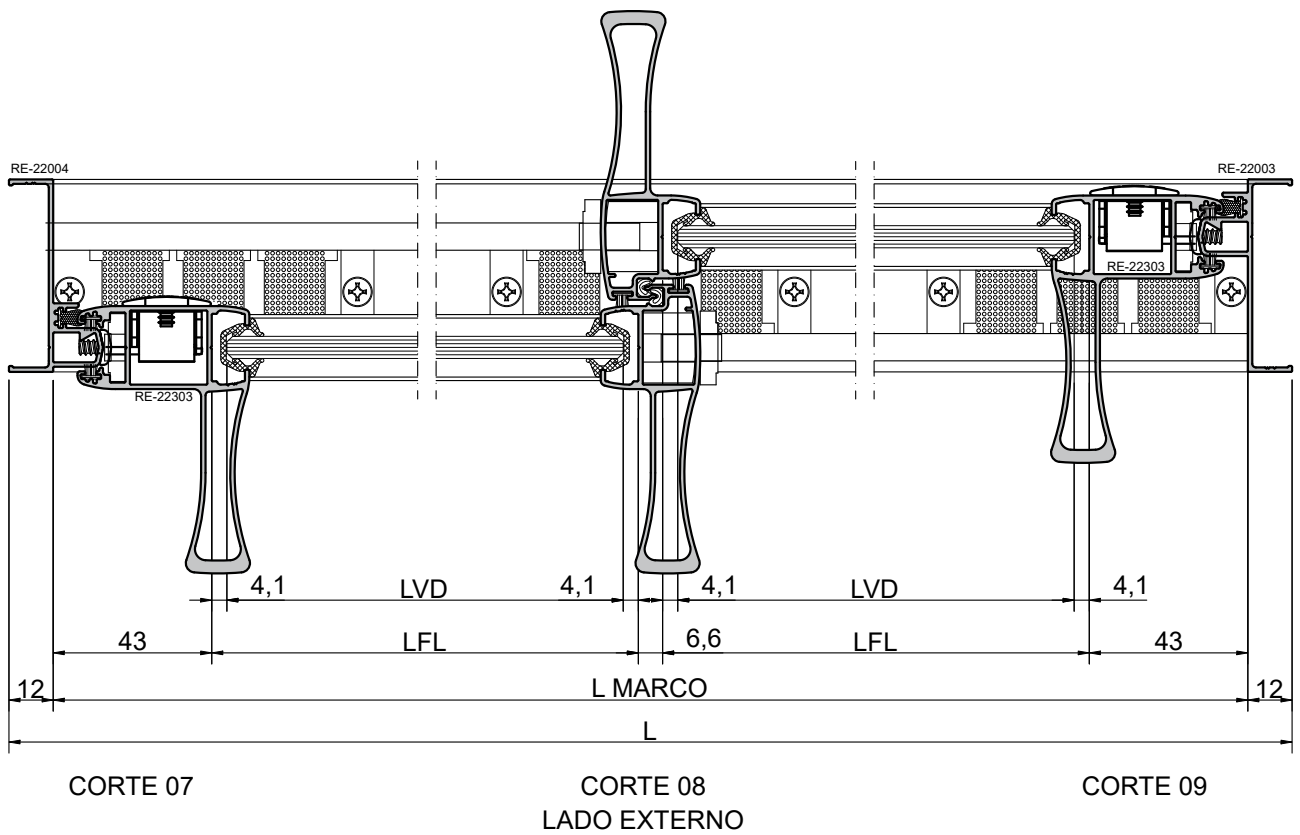













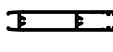

ESC.: 1:2

JANELA DE CORRER

2 FOLHAS PARA 2 PLANOS

MARCO LATERAL COM MATA-JUNTA SOLIDARIZADOS



PERFIS					
CROQUI	CÓDIGO	CORTE	TAMANHO	QDE.	USINAGEM
	RE-22001	90 / 90	L-24	1	
	RE-22012	90 / 90	L-24	1	USI 11
	RE-22003	90 / 90	H	1	USI 2
	RE-22004	90 / 90	H	1	USI 2
	RE-22501	90 / 90	(L-117) / 2	2	
	RE-22503	90 / 90	(L-117) / 2	2	USI 15
	RE-22501	90 / 90	(L-117) / 2	2	
	RE-22303	90 / 90	H-57	2	USI 13
	RE-22403	90 / 90	H-57	2	USI 14

GUARNIÇÕES/ESCOVAS			
CROQUI	CÓDIGO	MEDIDA	DESCRIÇÃO
	QL-5375	2*H	Qlon de vedação
	GXT-1128	(4*L)+(4*H)	Gaxeta p/ vidro 6 mm
	GNC-0001	2*H	Mão de amigo
	ECV-0010B	4*L	Escova 5X4 com barreira plastica
	EVC-0010B	6*H	Escova 5X4 com barreira plastica
	EVC-0001B	2*H	Escova 5X6 com barreira plastica

VIDRO PORTA	
LARGURA	(L-133)/2
ALTURA	A-141
ALTURA	B-85

PORTA DE CORRER 2 FOLHAS PARA 2 PLANOS

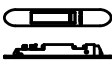
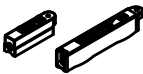
MARCO LATERAL COM MATA-JUNTA SOLIDARIZADOS

COMPONENTES				
CROQUI	REF.	QDE.	DESCRIÇÃO	OBS.
	PCP-4832PL	28	Fixação do marco/folha	
	VDA-22001	6	Vedação superior e inferior	Ver tabela de componentes
	DRN-22001	2	Dreno	Ver tabela de componentes
	CTF-0001	2	Contra fecho	Ver tabela de componentes
	FCH-0004	2	Fecho concha PORTA	Ver tabela de componentes
	TRV-22001	2	Lingueta fecho concha	Ver tabela de componentes
	GDE-22001	4	Guia da folha lateral	Ver tabela de componentes
	GDE-22002	4	Guia da folha mão de amigo	Ver tabela de componentes
	RLD-22002	4	Roldana da folha	Ver tabela de componentes
	BTE-0001	4	Batedeira da folha	Ver tabela de componentes
	TMT-0021	8	Tampa montante	Ver tabela de componentes
	TMT-0004	12	Tampa furo	Ver tabela de componentes
	VDA-22005	8	Espuma polietileno fechamento interno	Ver tabela de componentes
	VDA-0011	2	Lã pet isolamento dos rasgos das conchas	Ver tabela de componentes

PORTA DE CORRER
2 FOLHAS PARA 2 PLANOS

COM BANDEIRA FIXA

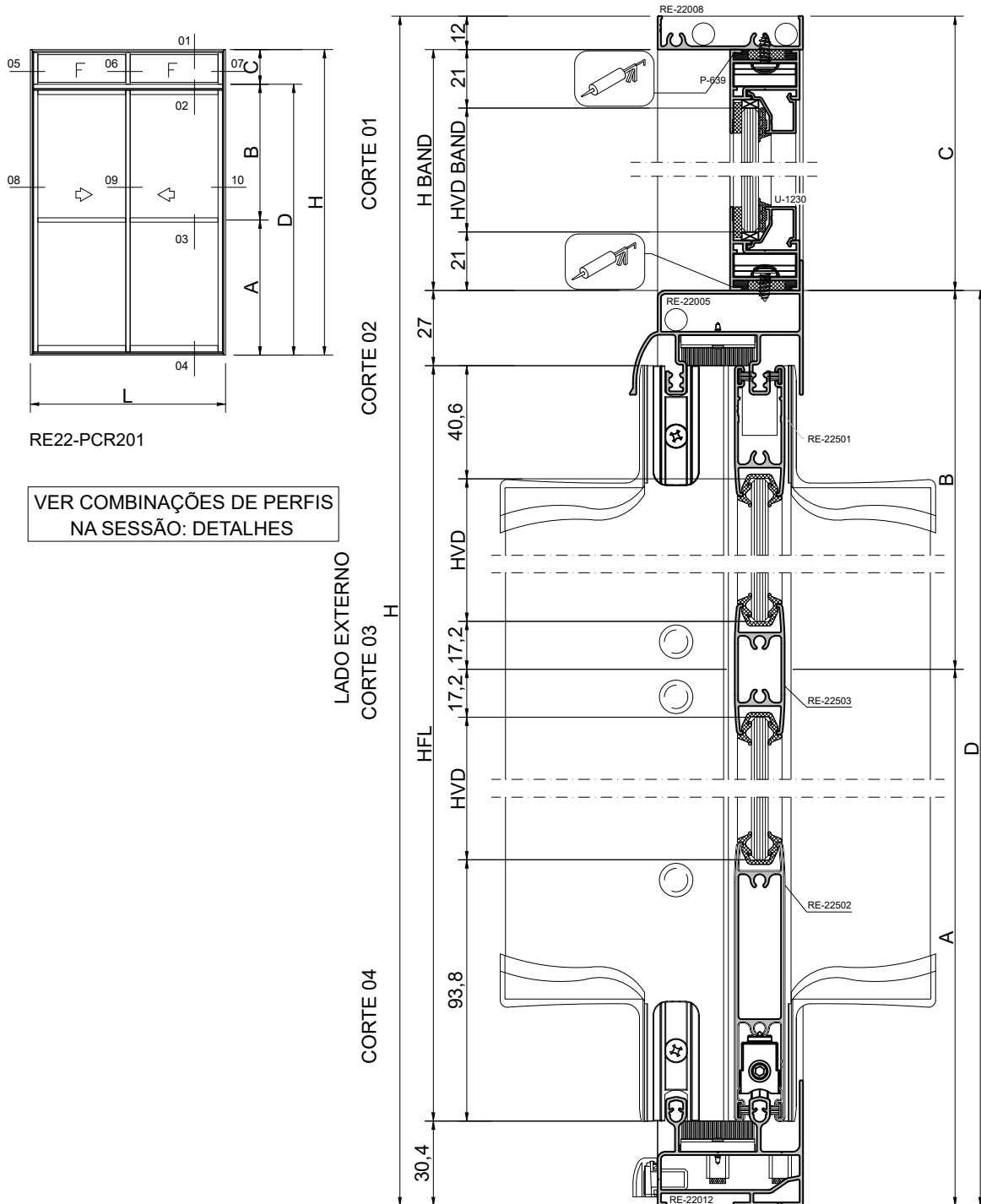

ESC.: 1:2

PORTA DE CORRER 2 FOLHAS PARA 2 PLANOS



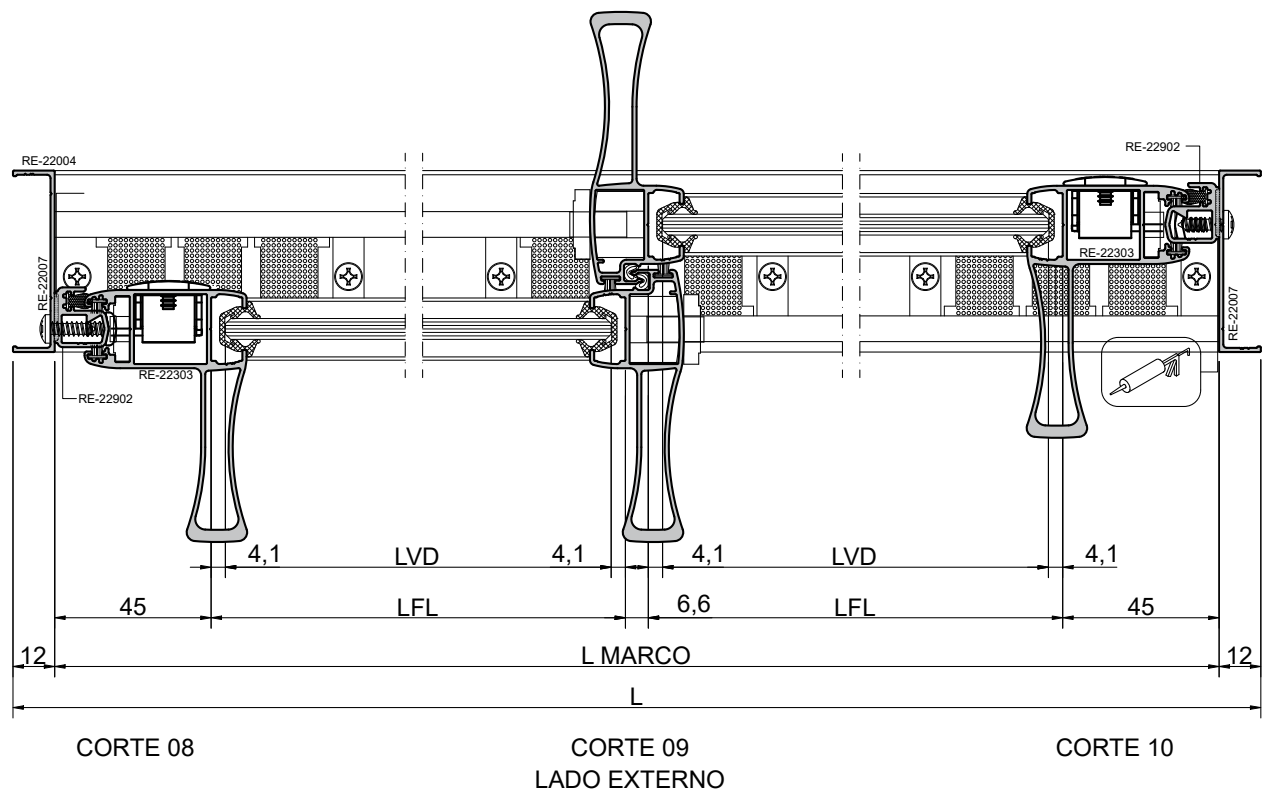
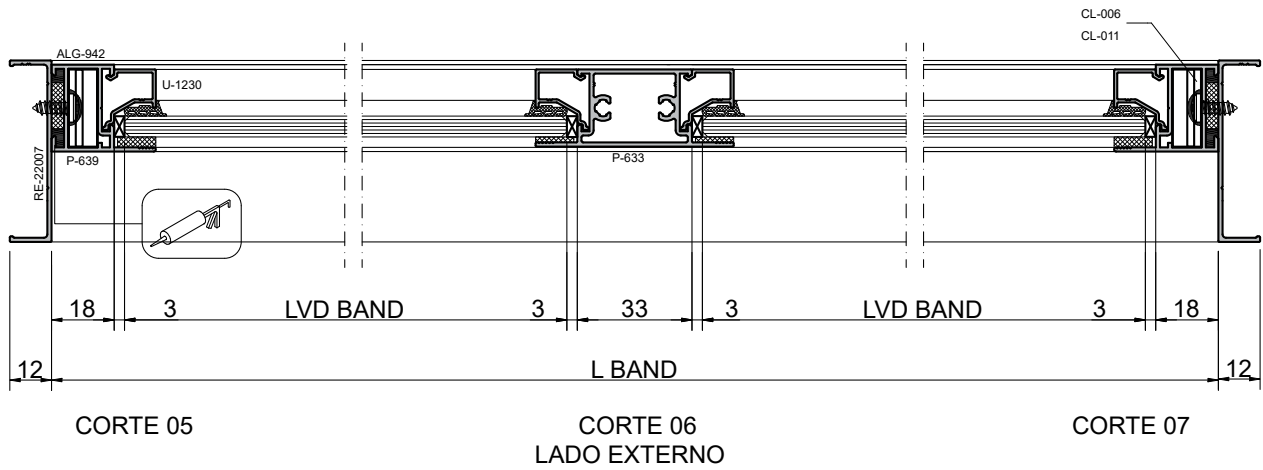













COM BANDEIRA FIXA











ESC.: 1:2

PORTA DE CORRER 2 FOLHAS PARA 2 PLANOS

COM BANDEIRA FIXA

PERFIS					
CROQUI	CÓDIGO	CORTE	TAMANHO	QDE.	USINAGEM
	RE-22008	90 / 90	L-24	1	
	RE-22005	90 / 90	L-24	1	
	RE-22012	90 / 90	L-24	1	USI 11
	RE-22007	90 / 90	H	2	USI 5
	RE-22902	90 / 90	D-57	2	USI 8
	RE-22501	90 / 90	(L-121)/2	2	
	RE-22503	90 / 90	(L-121)/2	2	USI 15
	RE-22501	90 / 90	(L-121) / 2	2	
	RE-22303	90 / 90	D-57	2	USI 13
	RE-22403	90 / 90	D-57	2	USI 14
	P-639	45 / 45	L-24	2	
	P-639	45 / 45	C-12	2	
	P-633	90 / 90	C-48	1	
	U-1230	90 / 90	(L-93)/2	4	
	U-1230	90 / 90	C-72	4	
	CL-006	90 / 90	21	4	
	CL-011	90 / 90	21	8	

GUARNIÇÕES/ESCOVAS			
CROQUI	CÓDIGO	MEDIDA	DESCRIÇÃO
	QL-5375	2*AB	Qlon de vedação
	GXT-1128	(4*L)+(4*AB)	Gaxeta p/ vidro 6 mm
	GNC-0001	2*AB	Mão de amigo
	ECV-0010B	4*L	Escova 5X4 com barreira plastica
	EVC-0010B	6*H	Escova 5X4 com barreira plastica
	EVC-0001B	2*H	Escova 5X6 com barreira plastica
	GNC-0010	(2*L)+(4*C)	Gaxeta de EPDM externa
	GNC-0012	(2*L)+(4*C)	Gaxeta de EPDM cunha
	GUA-259	(2*L)+(4*C)	Gaxeta de EPDM interna vidro 6mm

VIDRO PORTA

LARGURA	(L-137)/2
ALTURA	A-141
ALTURA	B-85

VIDRO BANDEIRA

LARGURA	(L-105)/2
ALTURA	C-54

PORTA DE CORRER 2 FOLHAS PARA 2 PLANOS

COM BANDEIRA FIXA

COMPONENTES				
CROQUI	REF.	QDE.	DESCRIÇÃO	OBS.
	PCP-4832PL	36	Fixação do marco/folha	
	PCP-3995	$((D/350)+1)*2$	Fixa mata junta	
	PCP-3995	$((2*(L+C))/350)+1$	Fixa bandeira	
	VDA-22001	6	Vedação superior e inferior	Ver tabela de componentes
	DRN-22001	2	Dreno	Ver tabela de componentes
	CTF-0001	2	Contra fecho	Ver tabela de componentes
	FCH-0004	2	Fecho concha PORTA	Ver tabela de componentes
	TRV-22001	2	Lingueta fecho concha	Ver tabela de componentes
	GDE-22001	4	Guia da folha lateral	Ver tabela de componentes
	GDE-22002	4	Guia da folha mão de amigo	Ver tabela de componentes
	RLD-22002	4	Roldana da folha	Ver tabela de componentes
	BTE-0001	4	Batedeira da folha	Ver tabela de componentes
	TMT-0021	8	Tampa montante	Ver tabela de componentes
	TMT-0004	12	Tampa furo	Ver tabela de componentes
	VDA-22005	8	Espuma polietileno fechamento interno	Ver tabela de componentes
	VDA-0011	2	Lã pet isolamento dos rasgos das conchas	Ver tabela de componentes
	P020010	16	Calço do vidro EPDM 6x3x50	Calço do vidro bandeira
	ESP-11x4	$(2*(L+C))$	Espuma polietileno 11x4	Vedação quadro fixo
	GUA-258	$(2*(L+C))$	Espuma polietileno 11x4	Esp. vidro 6 mm
	GUA-171	$2*C$	Espuma polietileno 11x3	Esp. vidro 6 mm coluna

PORTA DE CORRER
2 FOLHAS PARA 2 PLANOS

COM PERSIANA INTEGRADA
MANUAL

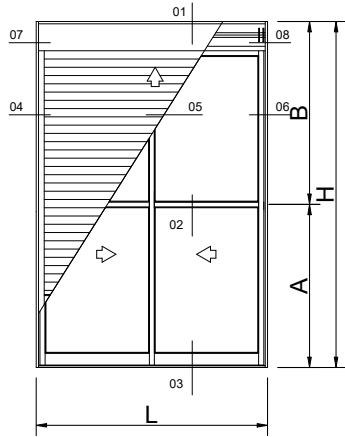

RE22-IPC200

VER COMBINAÇÕES DE PERFIS
NA SESSÃO: DETALHES

LADO EXTERNO

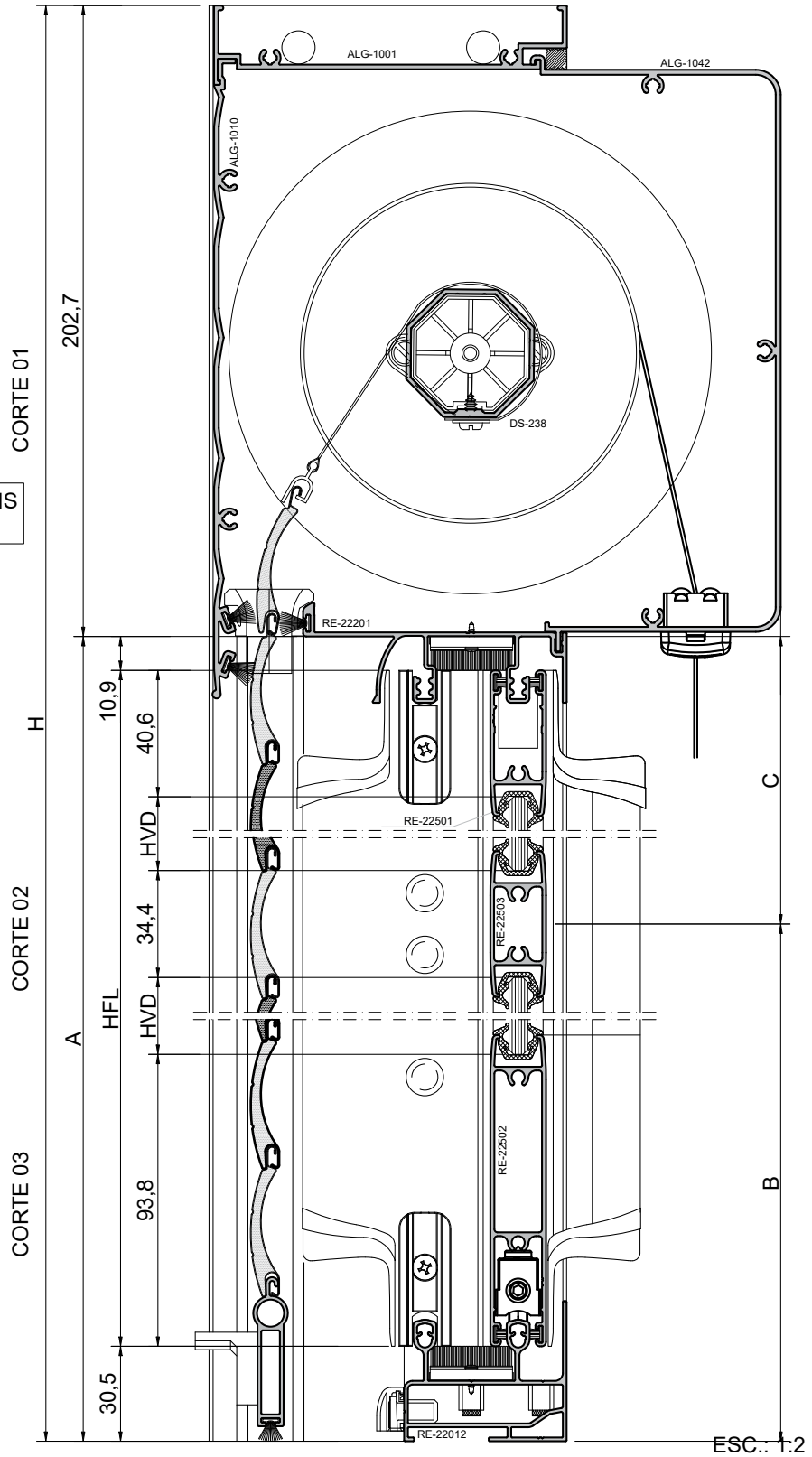

CORTE 01

CORTE 02

CORTE 03

ESC.: 1:2

PORTA DE CORRER

2 FOLHAS PARA 2 PLANOS



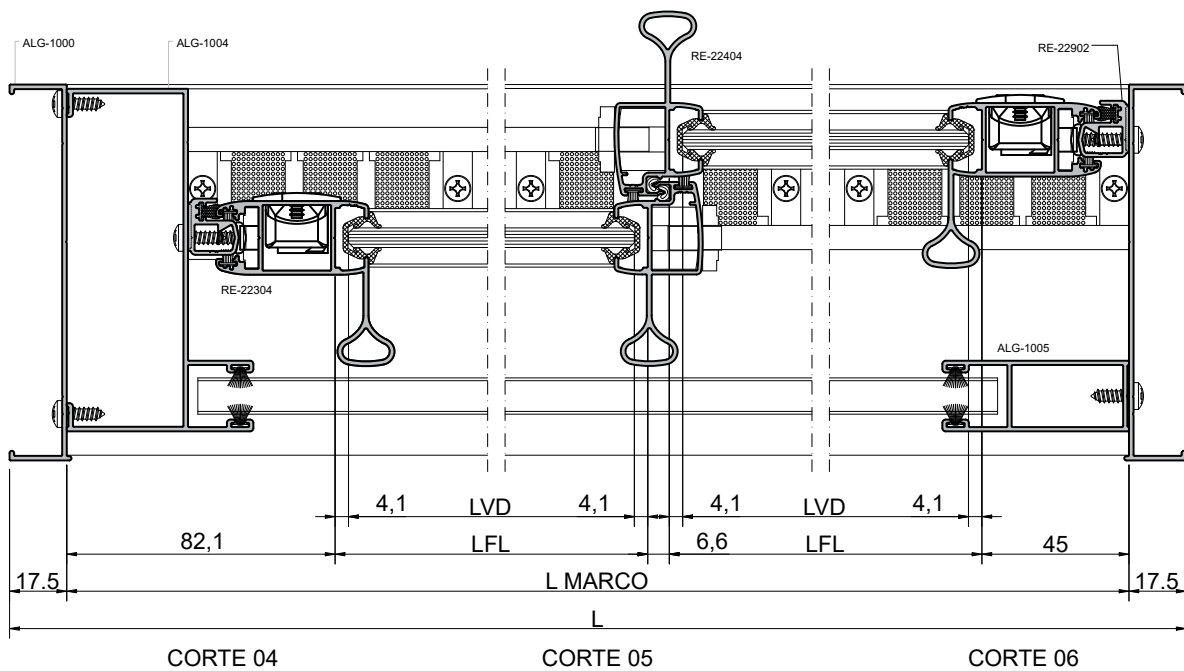
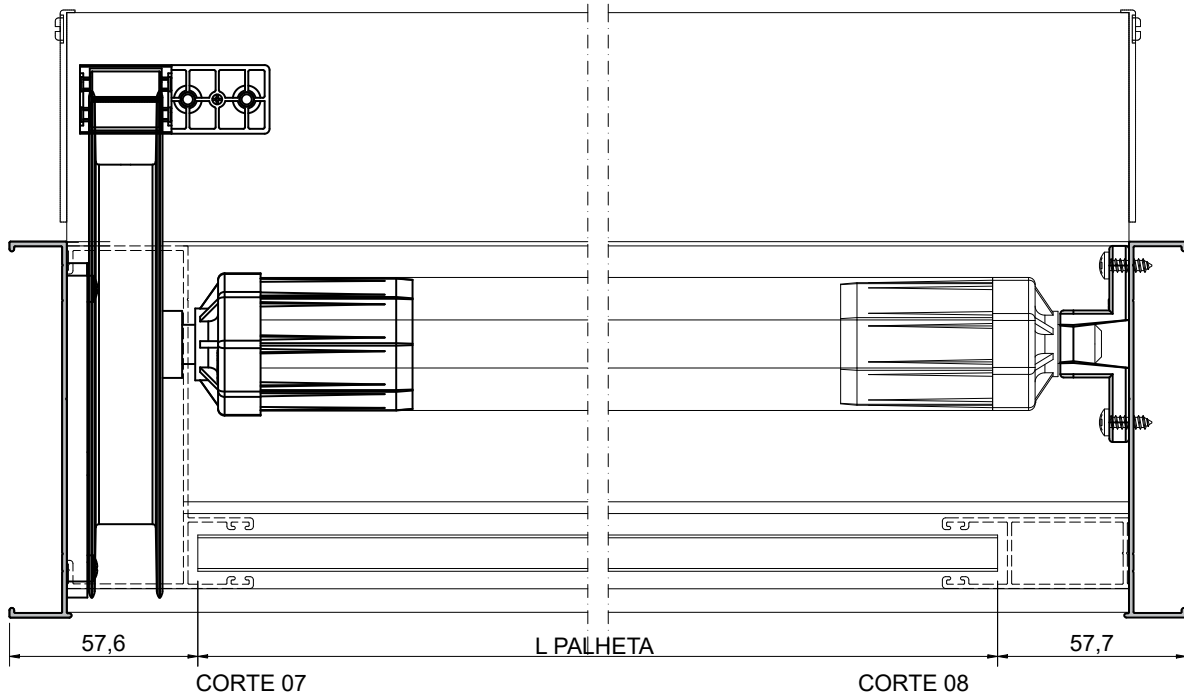







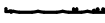
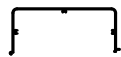

COM PERSIANA INTEGRADA MANUAL



LADO EXTERNO

ESC.: 1:2

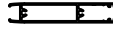
PORTA DE CORRER
2 FOLHAS PARA 2 PLANOS
COM PERSIANA INTEGRADA
MANUAL

PERFIS					
CROQUI	CÓDIGO	CORTE	TAMANHO	QDE.	USINAGEM
	ALG-1001	90 / 90	L-35	1	
	RE-22201	90 / 90	L-35	1	
	RE-22012	90 / 90	L-35	1	USI 11
	ALG-1007	90 / 90	L-35	1	
	ALG-1042	90 / 90	L-35	1	
	ALG-1000	90 / 90	H	2	USI 26
	ALG-1004	90 / 90	A	1	USI 22
	ALG-1005	90 / 90	A	1	USI 21
	DS-238	90 / 90	variável conforme fornecedor recolhedor	1	
	MN-055	90 / 09	L-115	1	
	RE-22902	90 / 90	A-41	2	USI 8
	RE-22501	90 / 90	(L-169)/2	2	
	RE-22503	90 / 90	(L-169)/2	2	USI 15
	RE-22501	90 / 90	(L-169) / 2	2	
	RE-22304	90 / 90	A-41	2	USI 13
	RE-22404	90 / 90	A-41	2	USI 14

PORTA DE CORRER 2 FOLHAS PARA 2 PLANOS

COM PERSIANA INTEGRADA MANUAL

COMPONENTES				
CROQUI	REF.	QDE.	DESCRIÇÃO	OBS.
	PCP-4832PL	36	Fixação marco/folha travessa	
	PCP-3995	$((A/350)+1)*2$	Fixa mata junta	
	PCP-3995	$((A/350)+1)*3$	Fixa ALG-1004/1005	
	VDA-22001	6	Vedação superior e inferior	Ver tabela de componentes
	DRN-22001	2	Dreno	Ver tabela de componentes
	CTF-0001	2	Contra fecho	Ver tabela de componentes
	FCH-0004	2	Fecho concha PORTA	Ver tabela de componentes
	TRV-22001	2	Lingueta fecho concha	Ver tabela de componentes
	GDE-22001	4	Guia da folha lateral	Ver tabela de componentes
	GDE-22002	4	Guia da folha mão de amigo	Ver tabela de componentes
	RLD-22002	4	Roldana da folha	Ver tabela de componentes
	TMT-0002	8	Tampa montante	Ver tabela de componentes
	TMT-0004	12	Tampa furo	Ver tabela de componentes
	BTE-0001	4	Batedeira da folha	Ver tabela de componentes
	VDA-22005	12	Espuma polietileno fechamento interno	Ver tabela de componentes
	VDA-0011	2	Lã pet isolamento os calços de vedação	Ver tabela de componentes
	GPE-0006	2	Guia da Esteira	Ver tabela de componentes

PORTA DE CORRER 2 FOLHAS PARA 2 PLANOS

COM PERSIANA INTEGRADA MANUAL

COMPONENTES				
CROQUI	REF.	QDE.	DESCRIÇÃO	OBS.
	RCO-0001	1	Recolhedor manual janela	Ver tabela de componentes
	GCT-0003	1	Guia inferior da cinta	Ver tabela de componentes
	FPE-0001	4	Fixador da esteira	Ver tabela de componentes
	LPE-0001	2	Limitador da esteira	Ver tabela de componentes
	TMT-0007	2	Tampa da caixa	Ver tabela de componentes
	DAP-0001	2	Disco alinhador da esteira	Ver tabela de componentes
	PAC-0001	VAR	Palheta cega passo 41mm	Ver tabela de componentes
	PAV-0001	VAR	Palheta ventilada passo 41mm	Ver tabela de componentes

GUARNIÇÕES/ESCOVAS			
CROQUI	CÓDIGO	MEDIDA	DESCRIÇÃO
	QL-5375	2*A	Qlon de vedação
	GXT-1128	(4*L)+(4*A)	Gaxeta p/ vidro 6 mm
	GNC-0001	2*A	Mão de amigo
	ECV-0010B	4*L	Escova 5X4 com barreira plastica
	EVC-0010B	4*A	Escova 5X4 com barreira plastica
	EVC-0001B	2*A	Escova 5X6 com barreira plastica
	GXT-1155	L	Gaxeta trava da tampa
	ECV-0012	3*L	Escova 5X12
	ECV-0004	L	Escova 5X7
	ECV-0006	4*A	Escova 5X8

VIDRO JANELA	
LARGURA	(L-185)/2
ALTURA	B-141
ALTURA	C-69

PORTA DE CORRER 2 FOLHAS PARA 2 PLANOS

COM PERSIANA INTEGRADA MANUAL

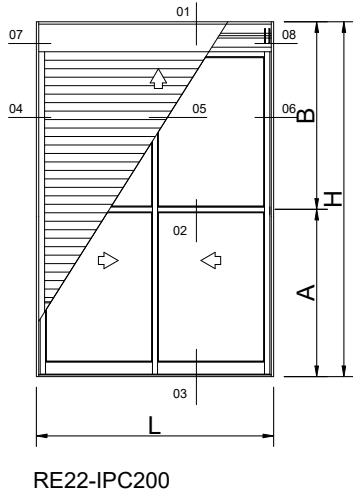

VER COMBINAÇÕES DE PERFIS
NA SESSÃO: DETALHES

LADO EXTERNO

CORTE 01

CORTE 02

CORTE 03

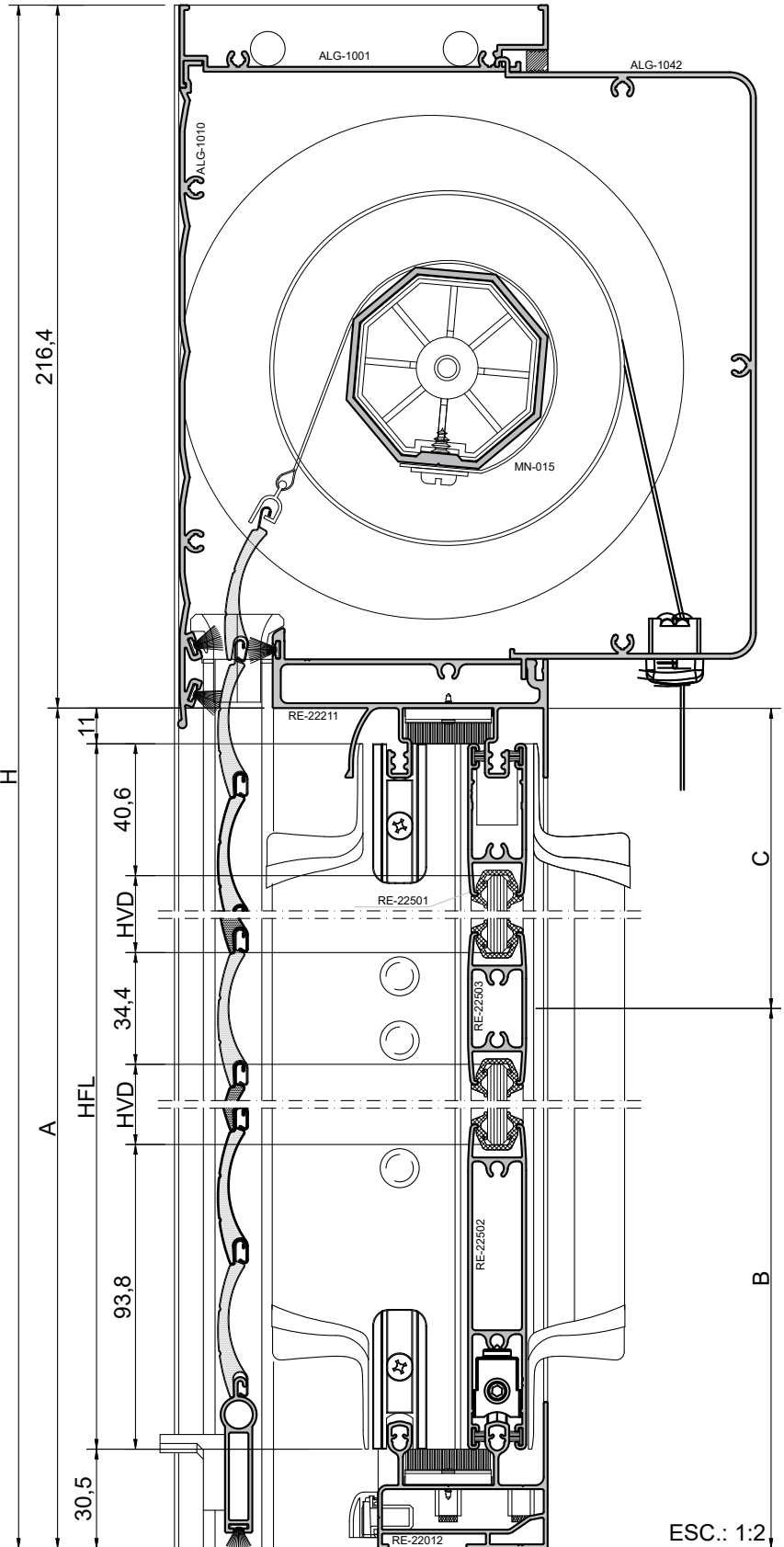

PORTA DE CORRER
2 FOLHAS PARA 2 PLANOS

COM PERSIANA INTEGRADA
MANUAL

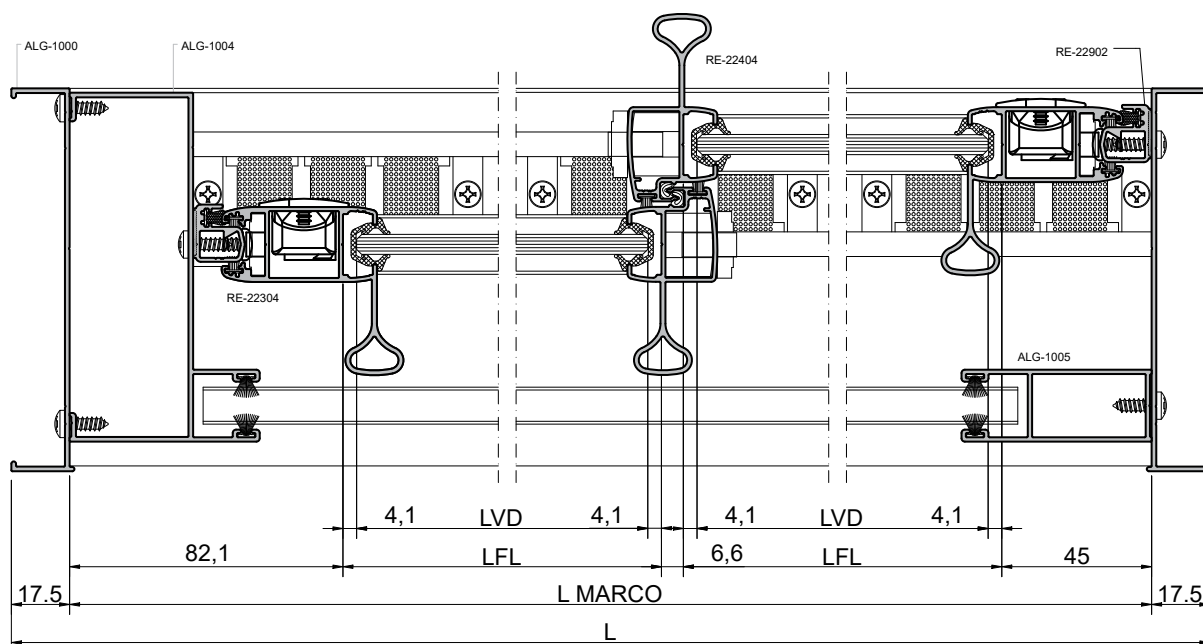
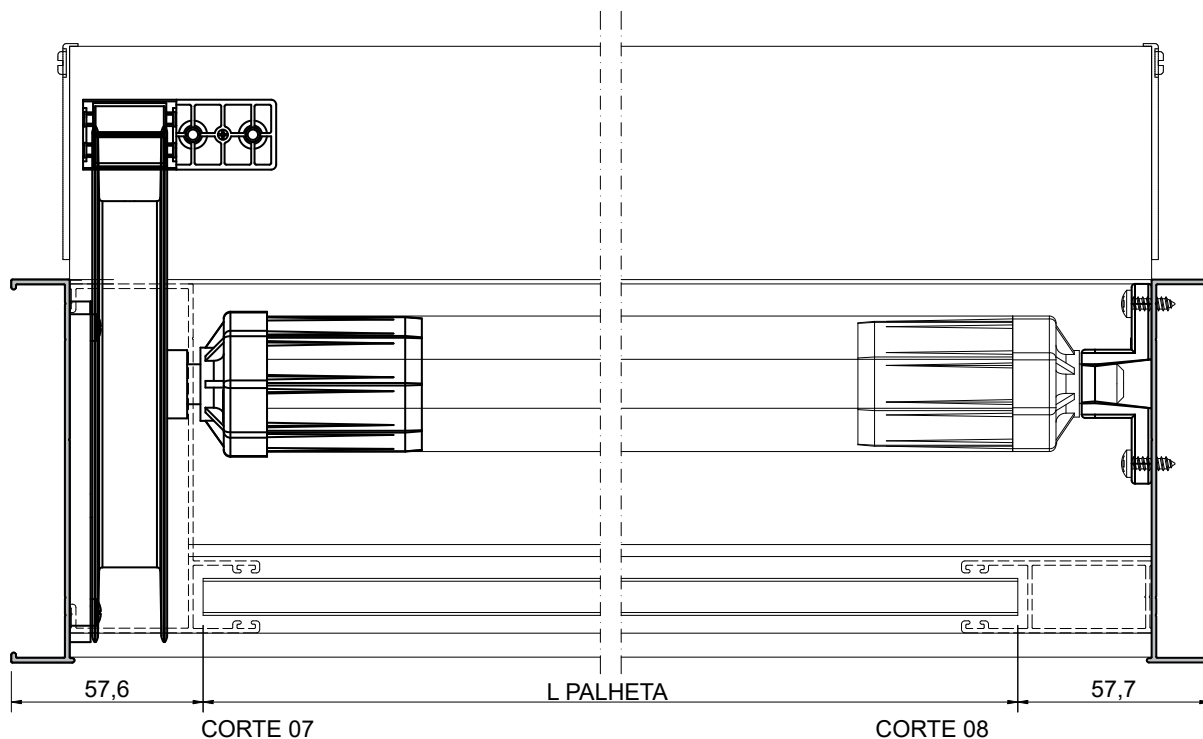













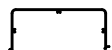

LADO EXTERNO

ESC.: 1:2

PORTA DE CORRER 2 FOLHAS PARA 2 PLANOS

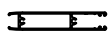
COM PERSIANA INTEGRADA MANUAL

PERFIS					
CROQUI	CÓDIGO	CORTE	TAMANHO	QDE.	USINAGEM
	ALG-1001	90 / 90	L-35	1	
	RE-22211	90 / 90	L-35	1	
	RE-22012	90 / 90	L-35	1	USI 11
	ALG-1007	90 / 90	L-35	1	
	ALG-1042	90 / 90	L-35	1	
	ALG-1000	90 / 90	H	2	USI 30
	ALG-1004	90 / 90	A+15	1	USI 23
	ALG-1005	90 / 90	A+15	1	USI 21
	MN-015	90 / 90	variável conforme fornecedor recolhedor	1	
	MN-055	90 / 09	L-115	1	
	RE-22902	90 / 90	A-41	2	USI 8
	RE-22501	90 / 90	(L-169)/2	2	
	RE-22503	90 / 90	(L-169)/2	2	USI 15
	RE-22501	90 / 90	(L-169) / 2	2	
	RE-22304	90 / 90	A-41	2	USI 13
	RE-22404	90 / 90	A-41	2	USI 14











PORTA DE CORRER
2 FOLHAS PARA 2 PLANOS
COM PERSIANA INTEGRADA
MANUAL

COMPONENTES				
CROQUI	REF.	QDE.	DESCRIÇÃO	OBS.
	PCP-4832PL	36	Fixação marco/folha travessa	
	PCP-3995	$((A/350)+1)*2$	Fixa mata junta	
	PCP-3995	$((A/350)+1)*3$	Fixa ALG-1004/1005	
	VDA-22001	6	Vedação superior e inferior	Ver tabela de componentes
	DRN-22001	2	Dreno	Ver tabela de componentes
	CTF-0001	2	Contra fecho	Ver tabela de componentes
	FCH-0004	2	Fecho concha PORTA	Ver tabela de componentes
	TRV-22001	2	Lingueta fecho concha	Ver tabela de componentes
	GDE-22001	4	Guia da folha lateral	Ver tabela de componentes
	GDE-22002	4	Guia da folha mão de amigo	Ver tabela de componentes
	RLD-22002	4	Roldana da folha	Ver tabela de componentes
	TMT-0002	8	Tampa montante	Ver tabela de componentes
	TMT-0004	12	Tampa furo	Ver tabela de componentes
	BTE-0001	4	Batedeira da folha	Ver tabela de componentes
	VDA-22005	12	Espuma polietileno fechamento interno	Ver tabela de componentes
	VDA-0011	2	Lã pet isolamento os calços de vedação	Ver tabela de componentes
	GPE-0006	2	Guia da Esteira	Ver tabela de componentes

PORTA DE CORRER 2 FOLHAS PARA 2 PLANOS

COM PERSIANA INTEGRADA MANUAL

COMPONENTES				
CROQUI	REF.	QDE.	DESCRIÇÃO	OBS.
	RCO-0001	1	Recolhedor manual janela	Ver tabela de componentes
	GCT-0003	1	Guia inferior da cinta	Ver tabela de componentes
	FPE-0001	4	Fixador da esteira	Ver tabela de componentes
	LPE-0001	2	Limitador da esteira	Ver tabela de componentes
	TMT-0007	2	Tampa da caixa	Ver tabela de componentes
	DAP-0001	2	Disco alinhador da esteira	Ver tabela de componentes
	PAC-0001	VAR	Palheta cega passo 41mm	Ver tabela de componentes
	PAV-0001	VAR	Palheta ventilada passo 41mm	Ver tabela de componentes

GUARNIÇÕES/ESCOVAS			
CROQUI	CÓDIGO	MEDIDA	DESCRIÇÃO
	QL-5375	2*A	Qlon de vedação
	GXT-1128	(4*L)+(4*A)	Gaxeta p/ vidro 6 mm
	GNC-0001	2*A	Mão de amigo
	ECV-0010B	4*L	Escova 5X4 com barreira plastica
	EVC-0010B	4*A	Escova 5X4 com barreira plastica
	EVC-0001B	2*A	Escova 5X6 com barreira plastica
	GXT-1155	L	Gaxeta trava da tampa
	ECV-0012	3*L	Escova 5X12
	ECV-0004	L	Escova 5X7
	ECV-0006	4*A	Escova 5X8

VIDRO JANELA	
LARGURA	(L-185)/2
ALTURA	B-141
ALTURA	C-69

PORTA DE CORRER
2 FOLHAS PARA 2 PLANOS

COM PERSIANA INTEGRADA
COM MOTOR

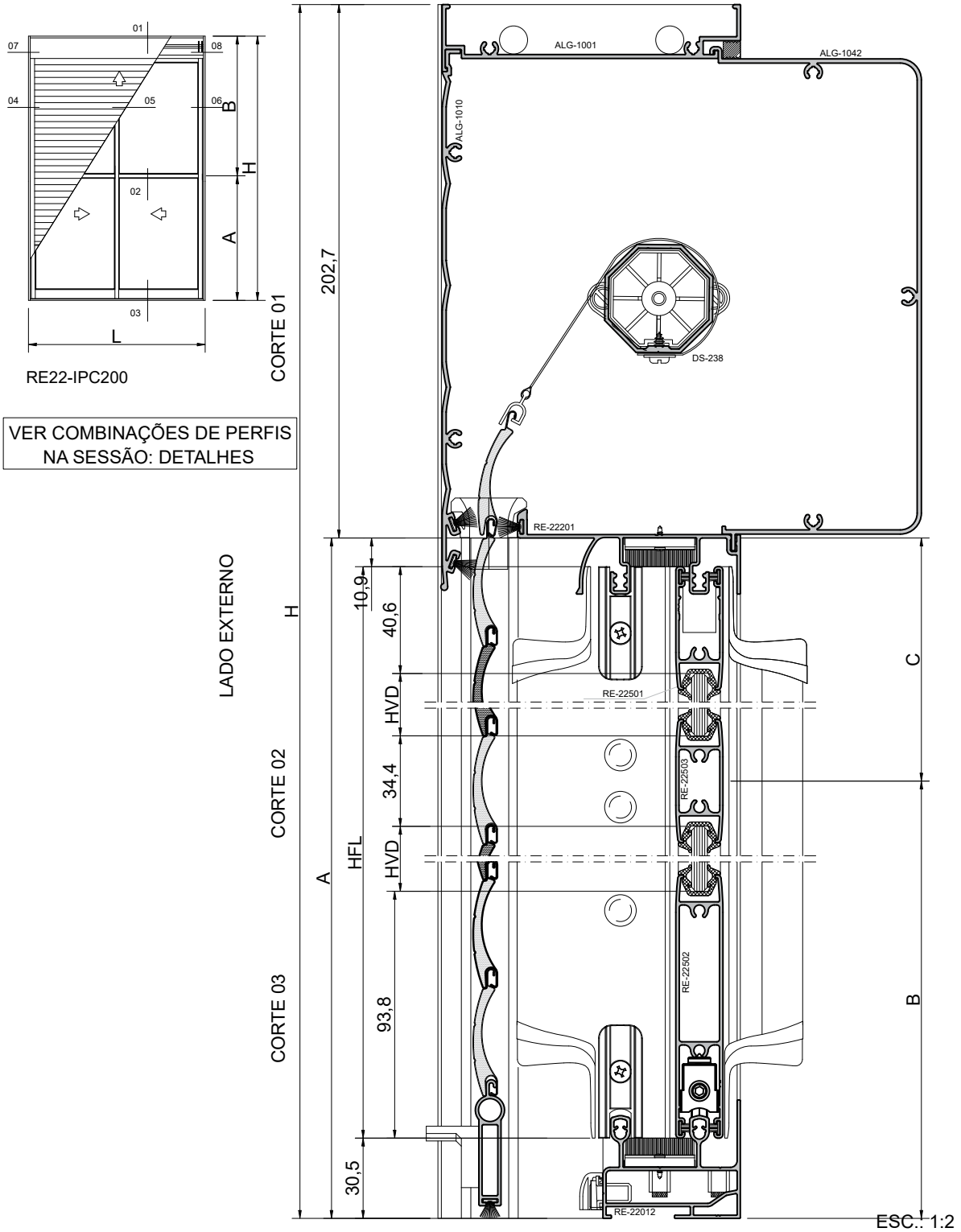

PORTA DE CORRER 2 FOLHAS PARA 2 PLANOS



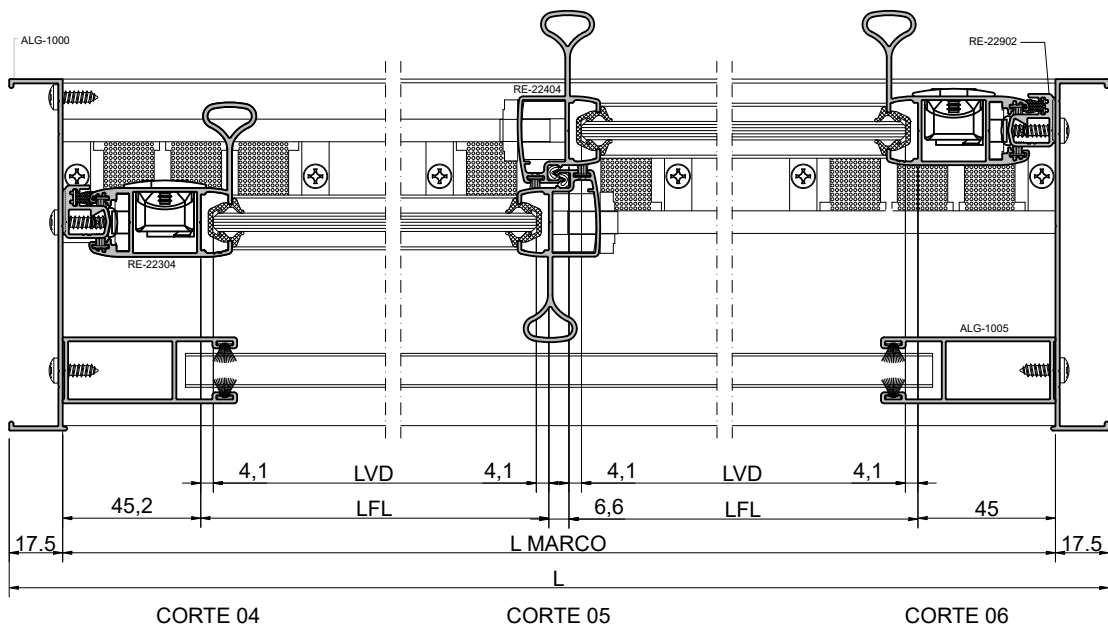
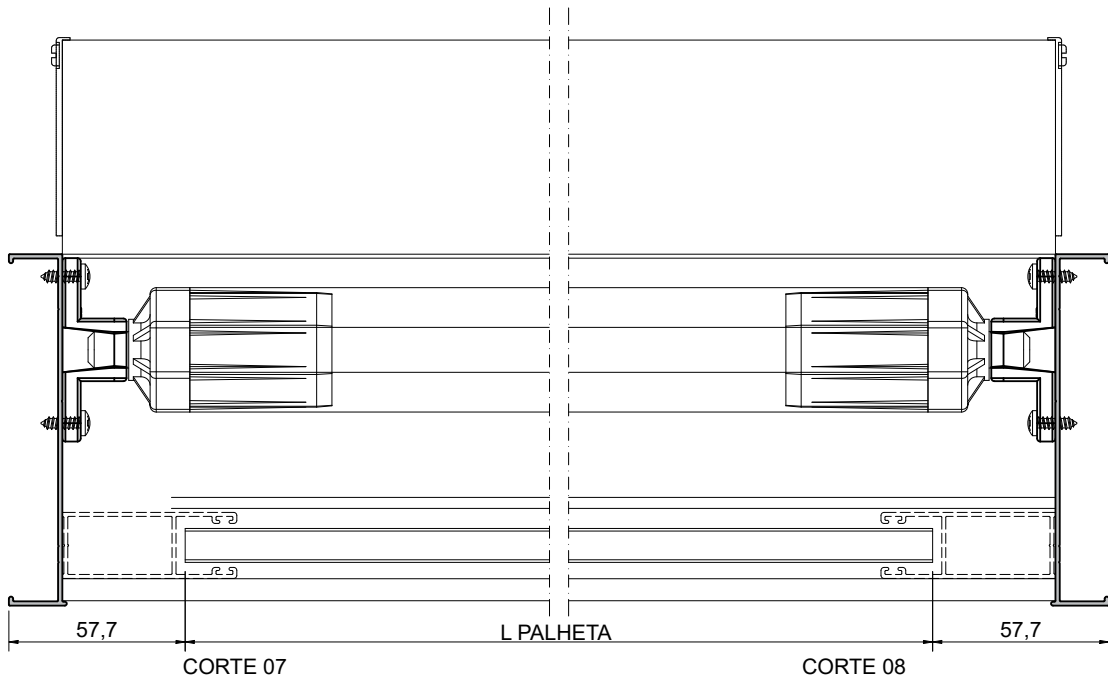







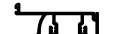

COM PERSIANA INTEGRADA
COM MOTOR

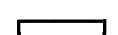

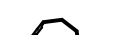
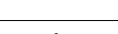
LADO EXTERNO

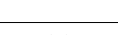
ESC.: 1:2

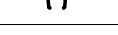
PORTA DE CORRER
2 FOLHAS PARA 2 PLANOS
COM PERSIANA INTEGRADA
COM MOTOR

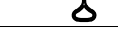
PERFIS					
CROQUI	CÓDIGO	CORTE	TAMANHO	QDE.	USINAGEM
	ALG-1001	90 / 90	L-35	1	
	RE-22201	90 / 90	L-35	1	
	RE-22012	90 / 90	L-35	1	USI 11
	ALG-1007	90 / 90	L-35	1	
	ALG-1042	90 / 90	L-35	1	
	ALG-1000	90 / 90	H	2	USI 26
	ALG-1005	90 / 90	A	2	USI 21
	DS-238	90 / 90	variável conforme fornecedor recolhedor	1	
	MN-055	90 / 09	L-115	1	
	RE-22902	90 / 90	A-41	2	USI 8
	RE-22501	90 / 90	(L-132)/2	2	
	RE-22503	90 / 90	(L-132)/2	2	USI 15
	RE-22501	90 / 90	(L-132) / 2	2	
	RE-22304	90 / 90	A-41	2	USI 13
	RE-22404	90 / 90	A-41	2	USI 14







PORTA DE CORRER 2 FOLHAS PARA 2 PLANOS

COM PERSIANA INTEGRADA COM MOTOR

COMPONENTES				
CROQUI	REF.	QDE.	DESCRIÇÃO	OBS.
	PCP-4832PL	36	Fixação marco/folha travessa	
	PCP-3995	$((A/350)+1)*2$	Fixa mata junta	
	PCP-3995	$((A/350)+1)*2$	Fixa ALG-1004/1005	
	VDA-22001	6	Vedação superior e inferior	Ver tabela de componentes
	DRN-22001	2	Dreno	Ver tabela de componentes
	CTF-0001	2	Contra fecho	Ver tabela de componentes
	FCH-0004	2	Fecho concha PORTA	Ver tabela de componentes
	TRV-22001	2	Lingueta fecho concha	Ver tabela de componentes
	GDE-22001	4	Guia da folha lateral	Ver tabela de componentes
	GDE-22002	4	Guia da folha mão de amigo	Ver tabela de componentes
	RLD-22002	4	Roldana da folha	Ver tabela de componentes
	TMT-0002	8	Tampa montante	Ver tabela de componentes
	TMT-0004	12	Tampa furo	Ver tabela de componentes
	BTE-0001	4	Batedeira da folha	Ver tabela de componentes
	VDA-22005	12	Espuma polietileno fechamento interno	Ver tabela de componentes
	VDA-0011	2	Lã pet isolamento os calços de vedação	Ver tabela de componentes
	GPE-0006	2	Guia da Esteira	Ver tabela de componentes

PORTA DE CORRER
2 FOLHAS PARA 2 PLANOS

COM PERSIANA INTEGRADA
COM MOTOR

COMPONENTES				
CROQUI	REF.	QDE.	DESCRIÇÃO	OBS.
	FPE-0001	4	Fixador da esteira	Ver tabela de componentes
	LPE-0001	2	Limitador da esteira	Ver tabela de componentes
	TMT-0007	2	Tampa da caixa	Ver tabela de componentes
	DAP-0001	2	Disco alinhador da esteira	Ver tabela de componentes
	PAC-0001	VAR	Palheta cega passo 41mm	Ver tabela de componentes
	PAV-0001	VAR	Palheta ventilada passo 41mm	Ver tabela de componentes

GUARNIÇÕES/ESCOVAS			
CROQUI	CÓDIGO	MEDIDA	DESCRIÇÃO
	QL-5375	2*A	Qlon de vedação
	GXT-1128	(2*L)+(4*A)	Gaxeta p/ vidro 6 mm
	GNC-0001	2*A	Mão de amigo
	ECV-0010B	4*L	Escova 5X4 com barreira plastica
	EVC-0010B	4*A	Escova 5X4 com barreira plastica
	EVC-0001B	2*A	Escova 5X6 com barreira plastica
	GXT-1155	L	Gaxeta trava da tampa
	ECV-0012	3*L	Escova 5X12
	ECV-0004	L	Escova 5X7
	ECV-0006	4*A	Escova 5X8

VIDRO JANELA	
LARGURA	(L-148)/2
ALTURA	B-141
ALTURA	C-69

PORTA DE CORRER 2 FOLHAS PARA 2 PLANOS

COM PERSIANA INTEGRADA COM MOTOR

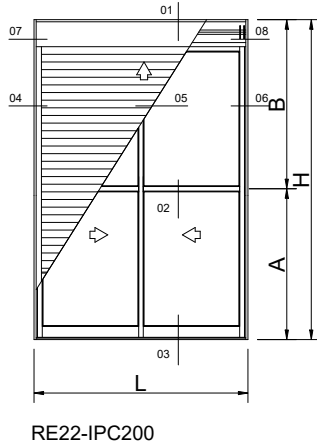

VER COMBINAÇÕES DE PERFIS
NA SESSÃO: DETALHES

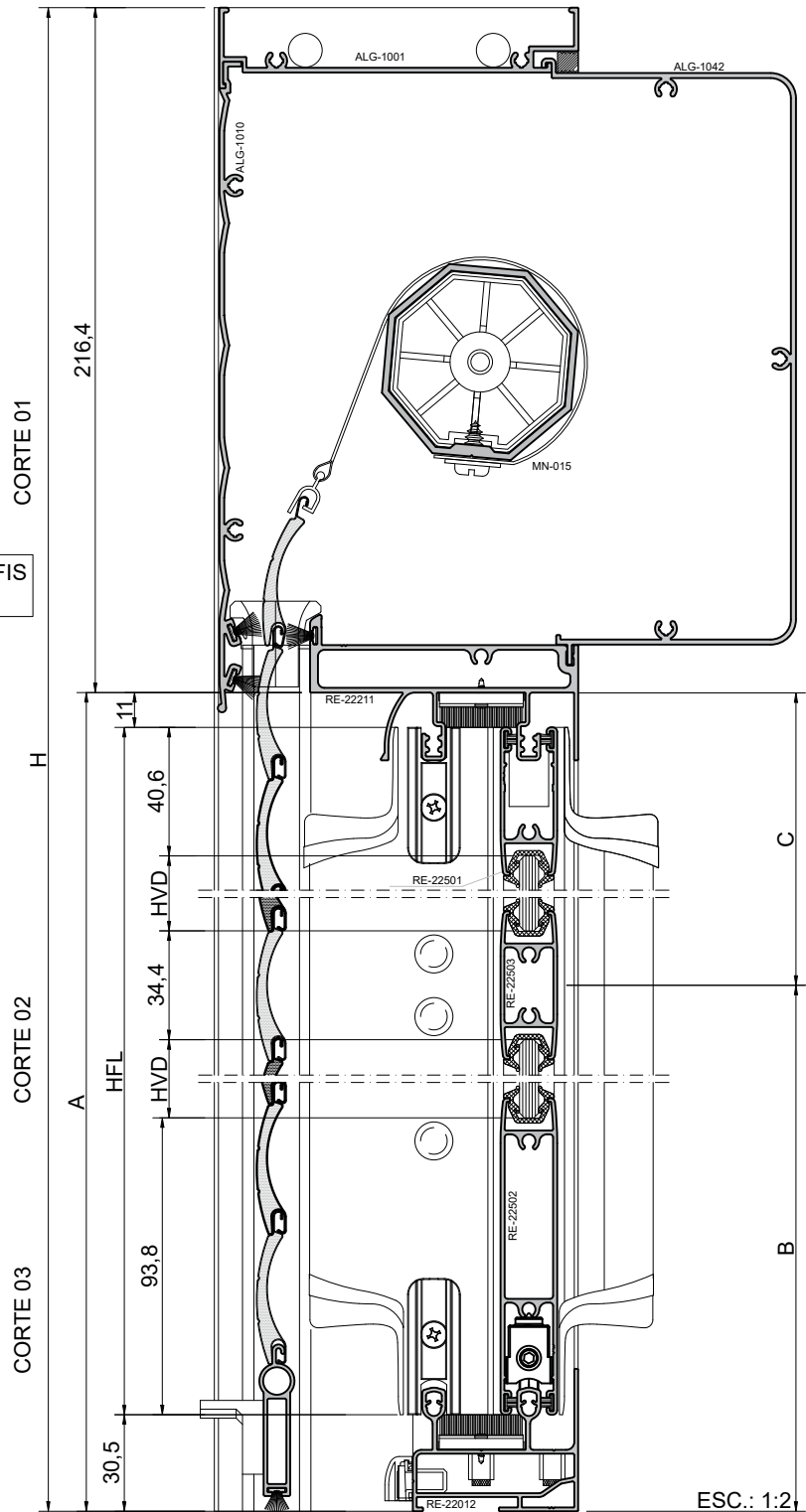

PORTA DE CORRER
2 FOLHAS PARA 2 PLANOS

COM PERSIANA INTEGRADA
COM MOTOR

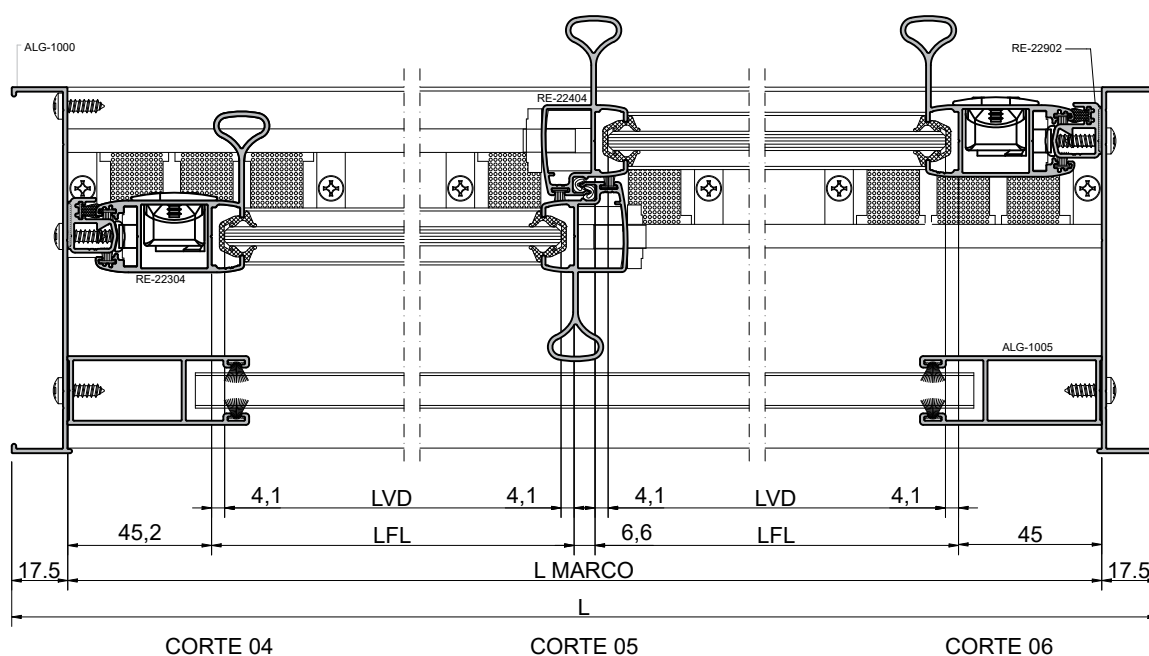
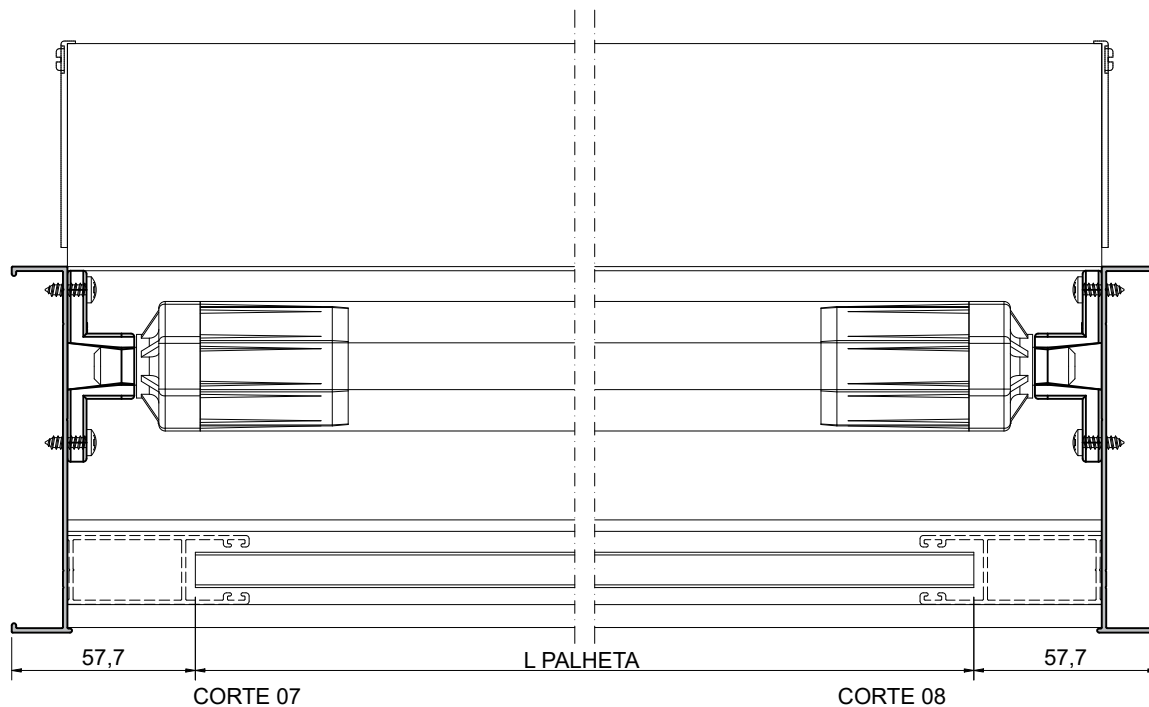









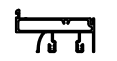

LADO EXTERNO

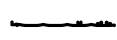
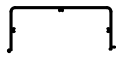
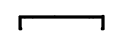
ESC.: 1:2

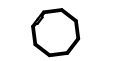
ESC.: 1:2

PORTA DE CORRER 2 FOLHAS PARA 2 PLANOS

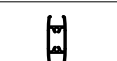
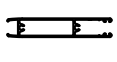
**COM PERSIANA INTEGRADA
COM MOTOR**







PERFIS					
CROQUI	CÓDIGO	CORTE	TAMANHO	QDE.	USINAGEM
	ALG-1001	90 / 90	L-35	1	
	RE-22211	90 / 90	L-35	1	
	RE-22012	90 / 90	L-35	1	USI 11
	ALG-1007	90 / 90	L-35	1	
	ALG-1042	90 / 90	L-35	1	
	ALG-1000	90 / 90	H	2	USI 30
	ALG-1005	90 / 90	A+15	2	USI 21
	MN-015	90 / 90	variável conforme fornecedor recolhedor	1	
	MN-055	90 / 09	L-115	1	
	RE-22902	90 / 90	A-41	2	USI 8
	RE-22501	90 / 90	(L-132)/2	2	
	RE-22503	90 / 90	(L-132)/2	2	USI 15
	RE-22501	90 / 90	(L-132) / 2	2	
	RE-22304	90 / 90	A-41	2	USI 13
	RE-22404	90 / 90	A-41	2	USI 14

PORTA DE CORRER
2 FOLHAS PARA 2 PLANOS
COM PERSIANA INTEGRADA
COM MOTOR

COMPONENTES				
CROQUI	REF.	QDE.	DESCRIÇÃO	OBS.
	PCP-4832PL	36	Fixação marco/folha travessa	
	PCP-3995	$((A/350)+1)*2$	Fixa mata junta	
	PCP-3995	$((A/350)+1)*2$	Fixa ALG-1004/1005	
	VDA-22001	6	Vedação superior e inferior	Ver tabela de componentes
	DRN-22001	2	Dreno	Ver tabela de componentes
	CTF-0001	2	Contra fecho	Ver tabela de componentes
	FCH-0004	2	Fecho concha PORTA	Ver tabela de componentes
	TRV-22001	2	Lingueta fecho concha	Ver tabela de componentes
	GDE-22001	4	Guia da folha lateral	Ver tabela de componentes
	GDE-22002	4	Guia da folha mão de amigo	Ver tabela de componentes
	RLD-22002	4	Roldana da folha	Ver tabela de componentes
	TMT-0002	8	Tampa montante	Ver tabela de componentes
	TMT-0004	12	Tampa furo	Ver tabela de componentes
	BTE-0001	4	Batedeira da folha	Ver tabela de componentes
	VDA-22005	12	Espuma polietileno fechamento interno	Ver tabela de componentes
	VDA-0011	2	Lã pet isolamento os calços de vedação	Ver tabela de componentes
	GPE-0006	2	Guia da Esteira	Ver tabela de componentes

PORTA DE CORRER 2 FOLHAS PARA 2 PLANOS

**COM PERSIANA INTEGRADA
COM MOTOR**

COMPONENTES				
CROQUI	REF.	QDE.	DESCRIÇÃO	OBS.
	FPE-0001	4	Fixador da esteira	Ver tabela de componentes
	LPE-0001	2	Limitador da esteira	Ver tabela de componentes
	TMT-0005	2	Tampa da caixa	Ver tabela de componentes
	DAP-0001	2	Disco alinhador da esteira	Ver tabela de componentes
	PAC-0001	VAR	Palheta cega passo 41mm	Ver tabela de componentes
	PAV-0001	VAR	Palheta ventilada passo 41mm	Ver tabela de componentes

GUARNIÇÕES/ESCOVAS			
CROQUI	CÓDIGO	MEDIDA	DESCRIÇÃO
	QL-5375	2*A	Qlon de vedação
	GXT-1128	(2*L)+(4*A)	Gaxeta p/ vidro 6 mm
	GNC-0001	2*A	Mão de amigo
	ECV-0010B	4*L	Escova 5X4 com barreira plastica
	EVC-0010B	4*A	Escova 5X4 com barreira plastica
	EVC-0001B	2*A	Escova 5X6 com barreira plastica
	GXT-1155	L	Gaxeta trava da tampa
	ECV-0012	3*L	Escova 5X12
	ECV-0004	L	Escova 5X7
	ECV-0006	4*A	Escova 5X8

VIDRO JANELA	
LARGURA	(L-148)/2
ALTURA	B-141
ALTURA	C-69

JANELA DE CORRER
4 FOLHAS PARA 2 PLANOS

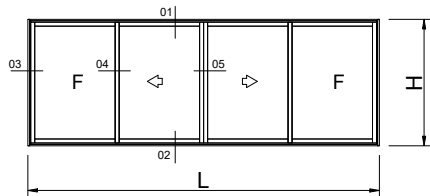

RE22-JCR400



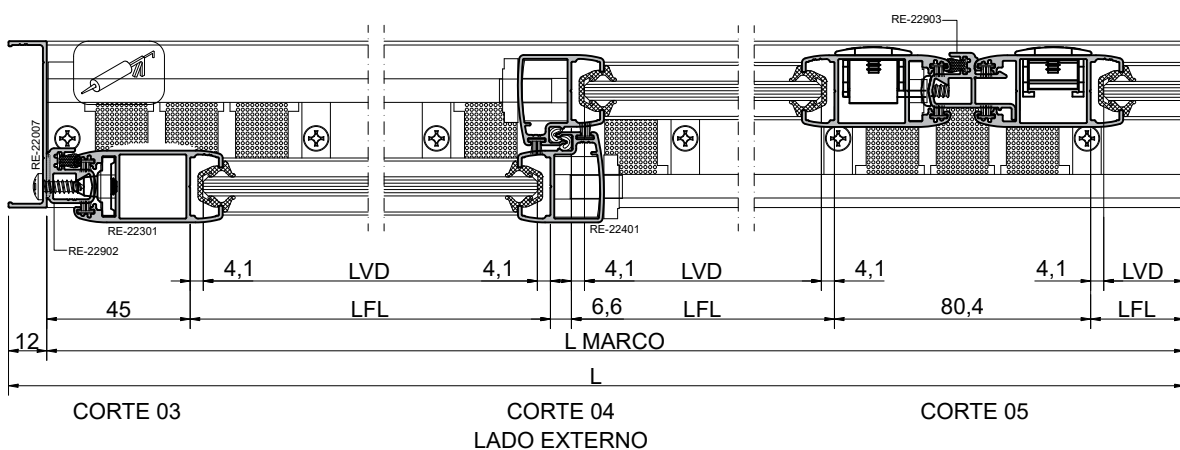
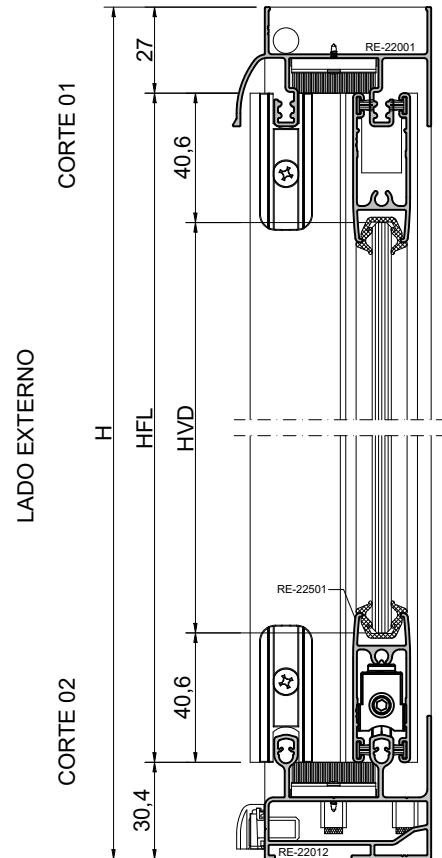





VER COMBINAÇÕES DE PERFIS
NA SESSÃO: DETALHES









ESC.: 1:2

JANELA DE CORRER

4 FOLHAS PARA 2 PLANOS

PERFIS					
CROQUI	CÓDIGO	CORTE	TAMANHO	QDE.	USINAGEM
	RE-22001	90 / 90	L-24	1	
	RE-22012	90 / 90	L-24	1	USI 10
	RE-22007	90 / 90	H	2	USI 1
	RE-22902	90 / 90	H-57	2	USI 8
	RE-22501	90 / 90	(L-208) / 4	8	
	RE-22301	90 / 90	H-57	4	USI 13
	RE-22401	90 / 90	H-57	4	USI 14
	RE-22903	90 / 90	H-57	1	USI 9

GUARNIÇÕES/ESCOVAS			
CROQUI	CÓDIGO	MEDIDA	DESCRIÇÃO
	QL-5375	3*H	Qlon de vedação
	GXT-1128	(2*L)+(8*H)	Gaxeta p/ vidro 6 mm
	GNC-0001	4*H	Mão de amigo
	ECV-0010B	4*L	Escova 5X4 com barreira plastica
	EVC-0010B	8*H	Escova 5X4 com barreira plastica
	EVC-0001B	8*H	Escova 5X6 com barreira plastica

VIDRO JANELA	
LARGURA	(L-240)/4
ALTURA	H-139

JANELA DE CORRER
4 FOLHAS PARA 2 PLANOS

COMPONENTES				
CROQUI	REF.	QDE.	DESCRIÇÃO	OBS.
	PCP-4832PL	16	Fixação do marco/folha	
	PCP-3995	$((H/350)+1)*2$	Fixa mata junta lateral	
	PCP-4219	$(H/350)+1$	Fixa mata junta central	
	VDA-22001	10	Vedação superior e inferior	Ver tabela de componentes
	DRN-22001	3	Dreno	Ver tabela de componentes
	CTF-0001	1	Contra fecho	Ver tabela de componentes
	FCH-0002	1	Fecho concha JANELA	Ver tabela de componentes
	CHC-0001	1	Concha cega JANELA	Ver tabela de componentes
	TRV-22001	1	Lingueta fecho concha	Ver tabela de componentes
	GDE-22001	8	Guia da folha lateral	Ver tabela de componentes
	GDE-22002	8	Guia da folha mão de amigo	Ver tabela de componentes
	RLD-22001	4	Roldana da folha	Ver tabela de componentes
	BTE-0008	4	Batedeira da folha	Ver tabela de componentes
	CAL-0001	4	Calço da folha fixa	Ver tabela de componentes
	TRV-22003	4	Trava da folha fixa	Ver tabela de componentes
	VDA-22005	18	Espuma polietileno fechamento interno	Ver tabela de componentes
	VDA-0011	2	Lã pet isolamento dos rasgos das conchas	Ver tabela de componentes

JANELA DE CORRER

4 FOLHAS PARA 2 PLANOS

COM BANDEIRA FIXA

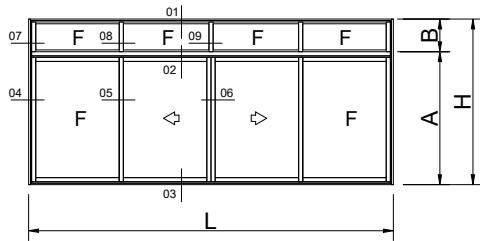

RE22-JCR401

VER COMBINAÇÕES DE PERFIS
NA SESSÃO: DETALHES

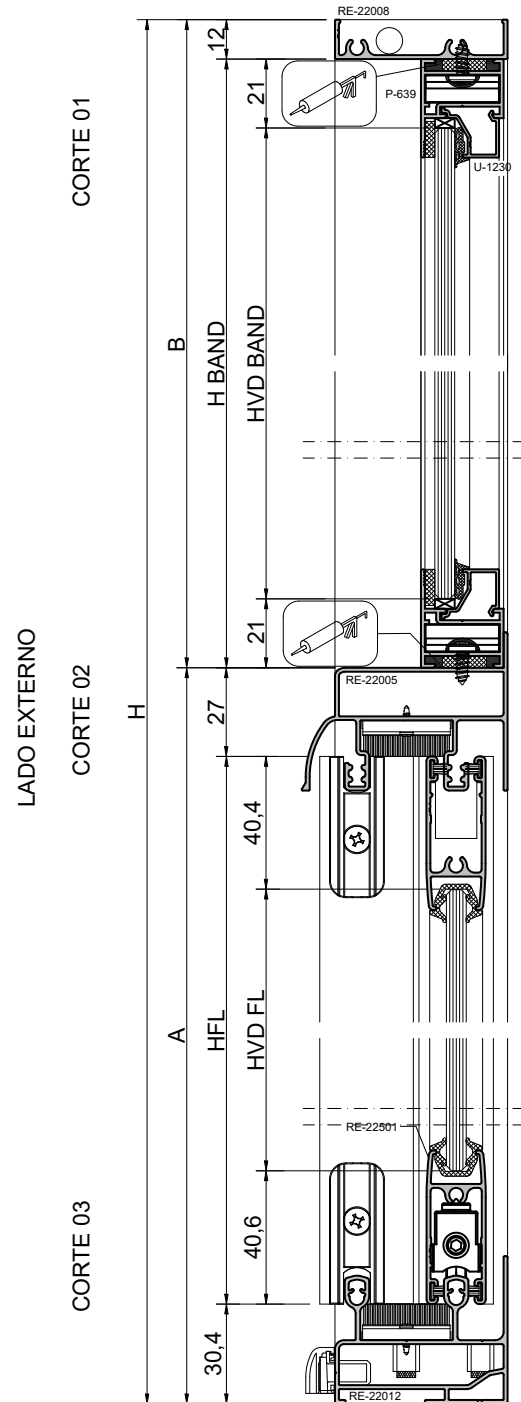

ESC.: 1:2

JANELA DE CORRER
4 FOLHAS PARA 2 PLANOS
COM BANDEIRA FIXA

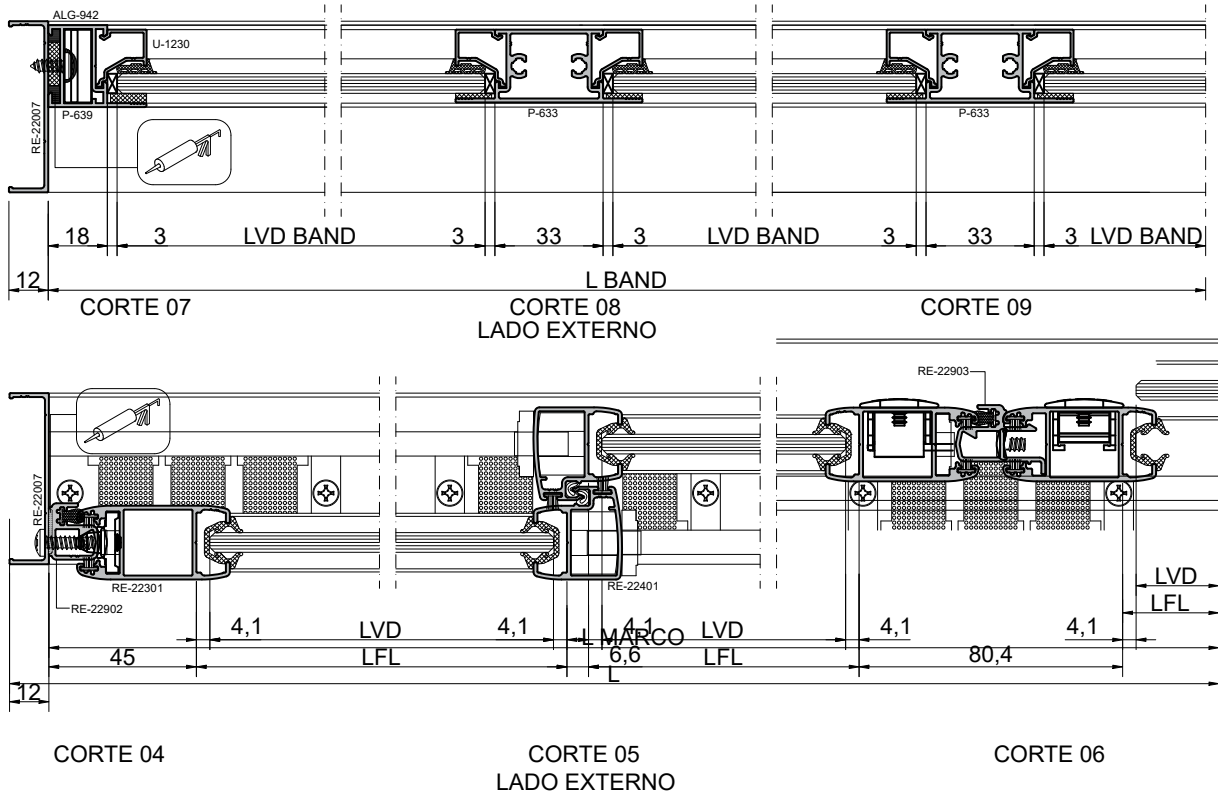

GUARNIÇÕES/ESCOVAS			
CROQUI	CÓDIGO	MEDIDA	DESCRIÇÃO
	QL-5375	2*A	Qlon de vedação
	GXT-1128	(2*L)+(8*A)	Gaxeta p/ vidro 6 mm
	GNC-0001	4*A	Mão de amigo
	ECV-0010B	4*L	Escova 5X4 com barreira plastica
	EVC-0010B	4*A	Escova 5X4 com barreira plastica
	EVC-0001B	8*A	Escova 5X6 com barreira plastica
	GUA-259	(2*L)+(8*B)	Gaxeta de EPDM interna vidro 6mm

VIDRO JANELA	
LARGURA	(L-240)/4
ALTURA	A-138









VIDRO BANDEIRA	
LARGURA	(L-183)/4
ALTURA	B-54

ESC.: 1:2

JANELA DE CORRER

4 FOLHAS PARA 2 PLANOS























COM BANDEIRA FIXA

PERFIS					
CROQUI	CÓDIGO	CORTE	TAMANHO	QDE.	USINAGEM
	RE-22008	90 / 90	L-24	1	
	RE-22005	90 / 90	L-24	1	
	RE-22012	90 / 90	L-24	1	USI 10
	RE-22007	90 / 90	H	2	USI 5
	RE-22902	90 / 90	A-57	2	USI 8
	RE-22903	90 / 09	A-57	1	USI 9
	RE-22501	90 / 90	(L-208)/4	8	
	RE-22301	90 / 90	A-57	4	USI 13
	RE-22401	90 / 90	A-57	4	USI 14
	P-639	45 / 45	L-24	2	
	P-639	45 / 45	B-12	2	
	P-633	90 / 90	B-48	3	
	U-1230	90 / 90	(L-159)/4	8	
	U-1230	90 / 90	B-72	8	
	CL-006	90 / 90	21	4	
	CL-011	90 / 90	21	8	

JANELA DE CORRER

4 FOLHAS PARA 2 PLANOS

COM BANDEIRA FIXA

COMPONENTES				
CROQUI	REF.	QDE.	DESCRIÇÃO	OBS.
	PCP-4832PL	40	Fixação do marco/folha/travessa	
	PCP-3995	$((A/350)+1) \times 2$	Fixa mata junta	
	PCP-3995	$((2*(L+B))/350)+1$	Fixa bandeira	
	PCP-4219	$(A/350)+1$	Fixa mata junta central	
	VDA-22001	10	Vedação superior e inferior	Ver tabela de componentes
	DRN-22001	3	Dreno	Ver tabela de componentes
	CTF-0001	1	Contra fecho	Ver tabela de componentes
	FCH-0002	1	Fecho concha JANELA	Ver tabela de componentes
	CHC-0001	1	Concha cega JANELA	Ver tabela de componentes
	TRV-22001	1	Lingueta fecho concha	Ver tabela de componentes
	GDE-22001	8	Guia da folha lateral	Ver tabela de componentes
	GDE-22002	8	Guia da folha mão de amigo	Ver tabela de componentes
	RLD-22001	4	Roldana da folha	Ver tabela de componentes
	BTE-0008	4	Batedeira da folha	Ver tabela de componentes
	CAL-0001	4	Calço da folha fixa	Ver tabela de componentes
	TRV-22003	4	Trava da folha fixa	Ver tabela de componentes
	VDA-22005	16	Espuma polietileno fechamento interno	Ver tabela de componentes
	VDA-0011	2	Lã pet isolamento dos rasgos das conchas	Ver tabela de componentes
	P020010	32	Calço do vidro EPDM 6x3x50	Calço do vidro bandeira
	ESP-11x4	$(2*(L+B))$	Espuma polietileno 11x4	Vedação quadro fixo
	GUA-258	$(2*(L+B))$	Espuma PVC 11X4	Esp. vidro 6 mm
	GUA-171	6*B	Espuma PVC 11x3	Esp. vidro 6 mm coluna

JANELA DE CORRER

4 FOLHAS PARA 2 PLANOS

COM PEITORIL FIXO

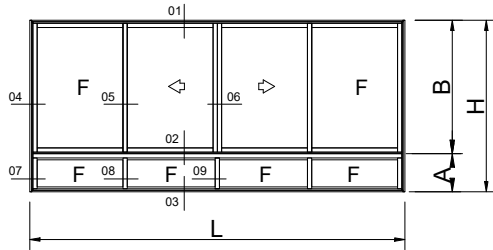

RE22-JCR402

VER COMBINAÇÕES DE PERFIS
NA SESSÃO: DETALHES

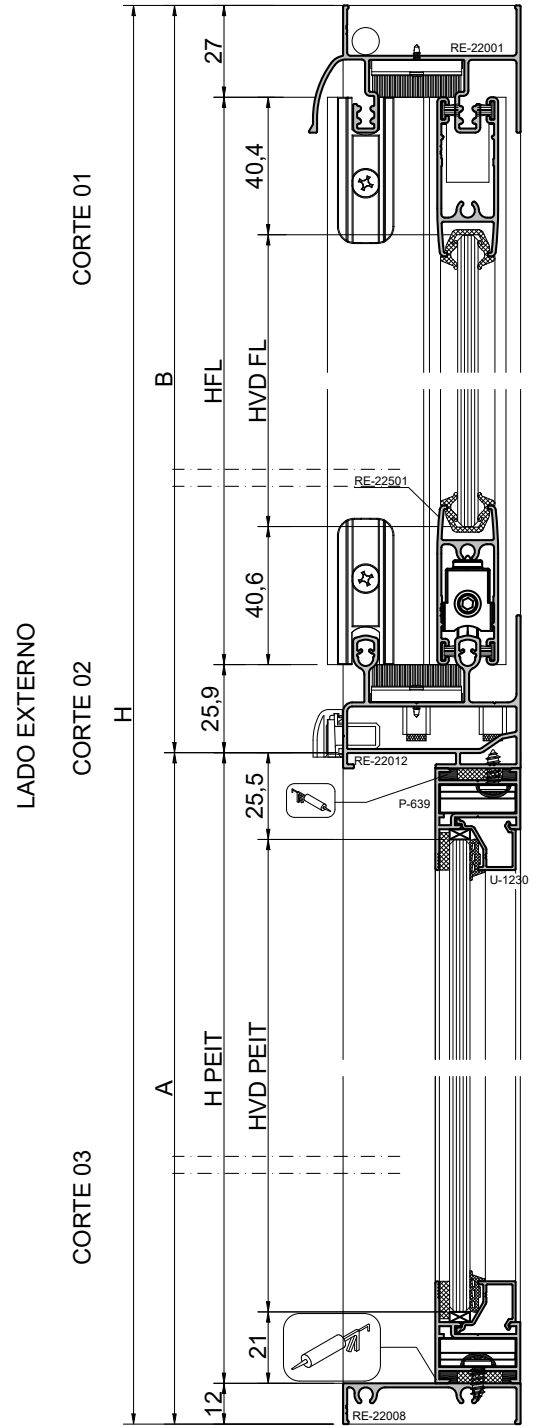

ESC.: 1:2

JANELA DE CORRER
4 FOLHAS PARA 2 PLANOS
COM PEITORIL FIXO

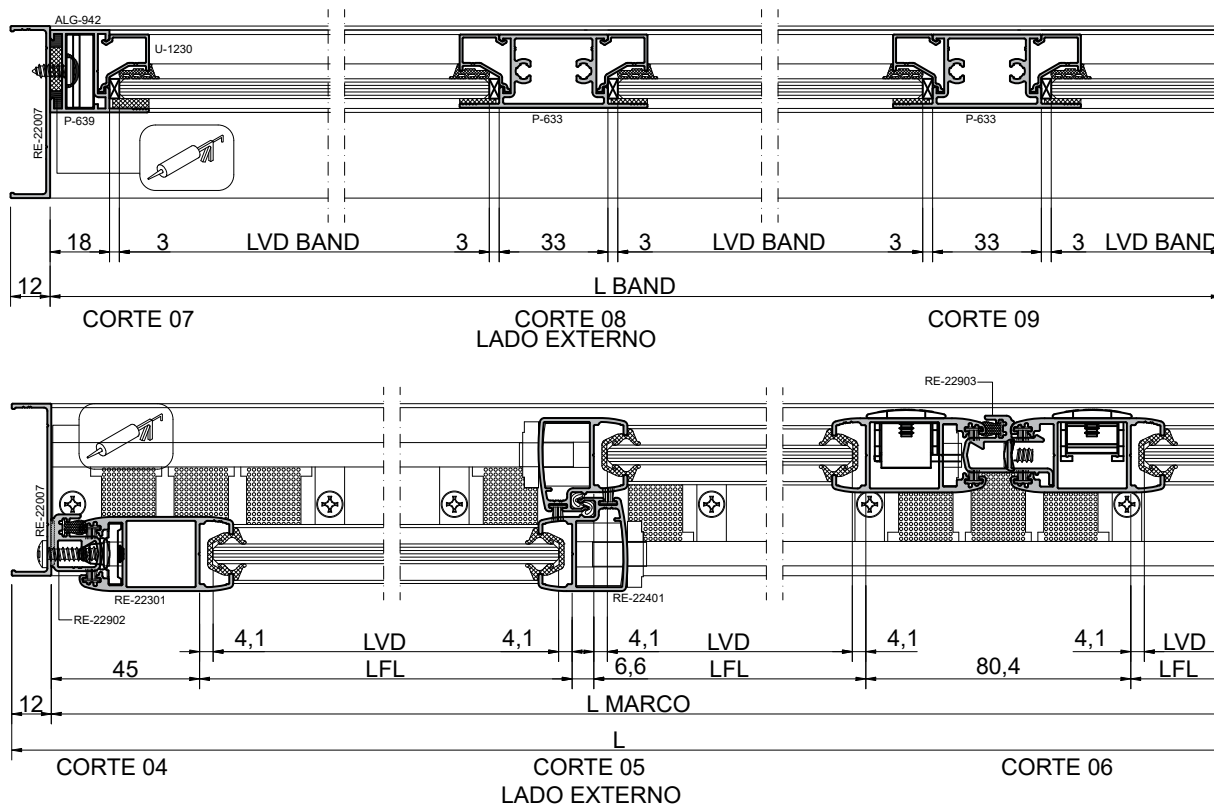

GUARNIÇÕES/ESCOVAS			
CROQUI	CÓDIGO	MEDIDA	DESCRIÇÃO
	QL-5375	2*A	Qlon de vedação
	GXT-1128	(2*L)+(8*B)	Gaxeta p/ vidro 6 mm
	GNC-0001	4*B	Mão de amigo
	ECV-0010B	4*L	Escova 5X4 com barreira plastica
	EVC-0010B	4*B	Escova 5X4 com barreira plastica
	EVC-0001B	8*B	Escova 5X6 com barreira plastica
	GUA-259	(2*L)+(8*A)	Gaxeta de EPDM interna vidro 6mm

VIDRO JANELA	
LARGURA	(L-240)/4
ALTURA	B-134

















VIDRO PEITORIL	
LARGURA	(L-183)/4
ALTURA	A-58

ESC.: 1:2

JANELA DE CORRER

4 FOLHAS PARA 2 PLANOS

COM PEITORIL FIXO

PERFIS					
CROQUI	CÓDIGO	CORTE	TAMANHO	QDE.	USINAGEM
	RE-22008	90 / 90	L-24	1	
	RE-22005	90 / 90	L-24	1	
	RE-22012	90 / 90	L-24	1	USI 10
	RE-22007	90 / 90	H	2	USI 5
	RE-22902	90 / 90	B-53	2	USI 8
	RE-20903	90 / 90	B-53	1	USI 9
	RE-22501	90 / 90	(L-208)/4	4	
	RE-22301	90 / 90	B-53	4	USI 13
	RE-22401	90 / 90	B-53	4	USI 14
	P-639	45 / 45	L-24	2	
	P-639	45 / 45	A-17	2	
	P-633	90 / 90	A-52	3	
	U-1230	90 / 90	(L-159)/4	8	
	U-1230	90 / 90	A-76	8	
	CL-006	90 / 90	21	4	
	CL-011	90 / 90	21	8	

JANELA DE CORRER
4 FOLHAS PARA 2 PLANOS
COM PEITORIL FIXO

COMPONENTES				
CROQUI	REF.	QDE.	DESCRIÇÃO	OBS.
	PCP-4832PL	40	Fixação do marco/folha/travessa	
	PCP-3995	$((B/350)+1) \times 2$	Fixa mata junta	
	PCP-3995	$((2*(L+A))/350)+1$	Fixa peitoril	
	PCP-4219	$(B/350)+1$	Fixa mata junta central	
	VDA-22001	10	Vedação superior e inferior	Ver tabela de componentes
	DRN-22001	3	Dreno	Ver tabela de componentes
	CTF-0001	1	Contra fecho	Ver tabela de componentes
	FCH-0002	1	Fecho concha JANELA	Ver tabela de componentes
	CHC-0001	1	Concha cega JANELA	Ver tabela de componentes
	TRV-22001	1	Lingueta fecho concha	Ver tabela de componentes
	GDE-22001	8	Guia da folha lateral	Ver tabela de componentes
	GDE-22002	8	Guia da folha mão de amigo	Ver tabela de componentes
	RLD-22001	4	Roldana da folha	Ver tabela de componentes
	BTE-0008	4	Batedeira da folha	Ver tabela de componentes
	CAL-0001	4	Calço da folha fixa	Ver tabela de componentes
	TRV-22003	4	Trava da folha fixa	Ver tabela de componentes
	VDA-22005	16	Espuma polietileno fechamento interno	Ver tabela de componentes
	VDA-0011	2	Lã pet isolamento dos rasgos das conchas	Ver tabela de componentes
	P020010	32	Calço do vidro EPDM 6x3x50	Calço do vidro peitoril
	ESP-11x4	$(2*(L+A))$	Espuma Polietileno 11x4	Vedação quadro fixo
	GUA-258	$(2*(L+A))$	Espuma PVC 11x4	Esp. vidro 6 mm
	GUA-171	$6*A$	Espuma PVC 11x3	Esp. vidro 6 mm coluna

JANELA DE CORRER

4 FOLHAS PARA 2 PLANOS

COM BANDEIRA E PEITORIL FIXO

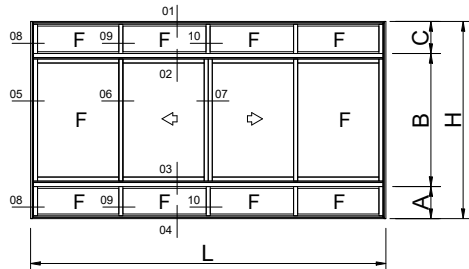

RE22-JCR403

VER COMBINAÇÕES DE PERFIS
NA SESSÃO: DETALHES

LADO EXTERNO

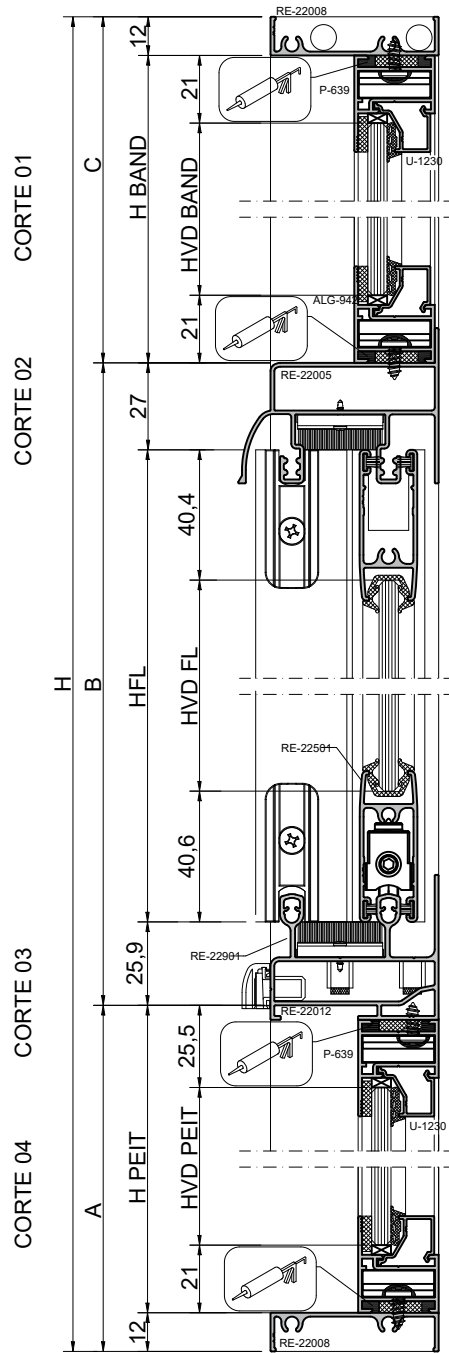

ESC.: 1:2

JANELA DE CORRER
4 FOLHAS PARA 2 PLANOS

COM BANDEIRA E PEITORIL FIXO

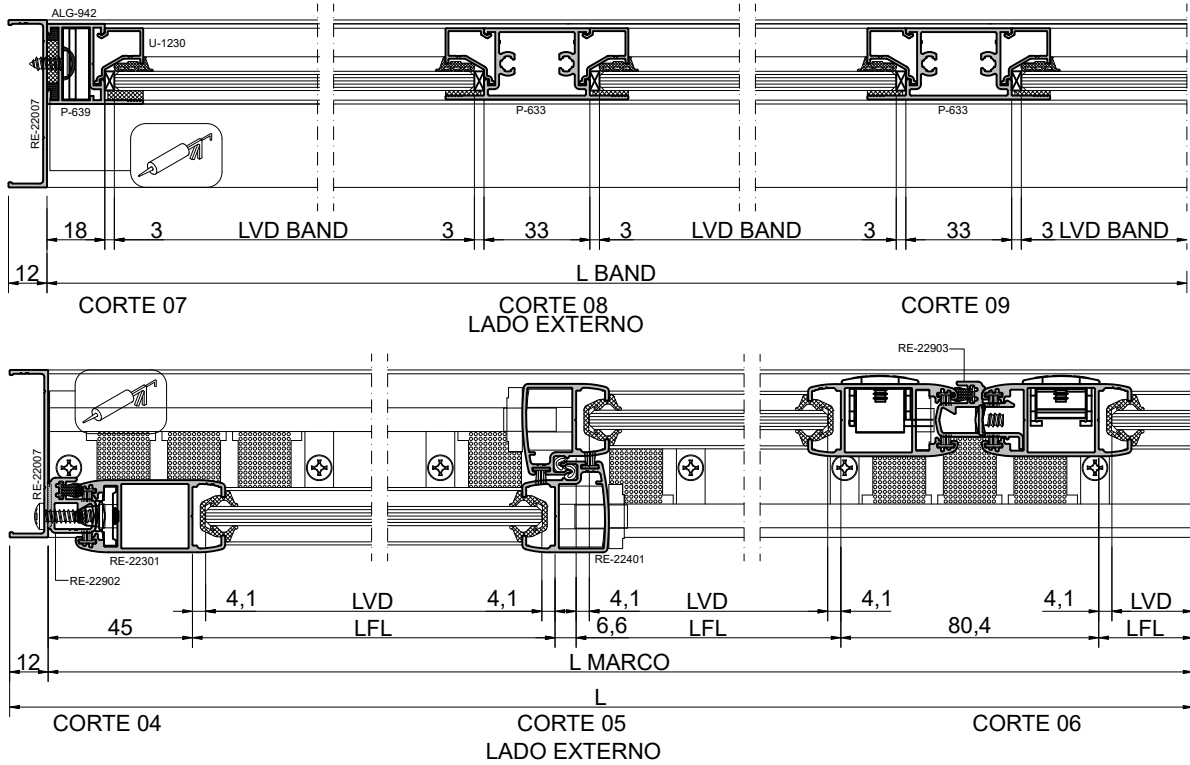





















GUARNIÇÕES/ESCOVAS			
CROQUI	CÓDIGO	MEDIDA	DESCRIÇÃO
	QL-5375	2*B	Qlon de vedação
	GXT-1128	(2*L)+(8*B)	Gaxeta p/ vidro 6 mm
	GNC-0001	4*B	Mão de amigo
	ECV-0010B	4*L	Escova 5X4 com barreira plastica
	EVC-0010B	8*B	Escova 5X4 com barreira plastica
	EVC-0001B	8*B	Escova 5X6 com barreira plastica
	GUA-259	(2*L)+(8*C)	Gaxeta de EPDM interna vidro 6mm
	GUA-259	(2*L)+(8*A)	Gaxeta de EPDM interna vidro 6mm

VIDRO JANELA	
LARGURA	(L-240)/4
ALTURA	B-134
VIDRO PEITORIL	
LARGURA	(L-183)/4
ALTURA	A-58
VIDRO BANDEIRA	
LARGURA	(L-183)/4
ALTURA	C-54

ESC.: 1:2

JANELA DE CORRER 4 FOLHAS PARA 2 PLANOS















COM BANDEIRA E PEITORIL FIXO

PERFIS					
CROQUI	CÓDIGO	CORTE	TAMANHO	QDE.	USINAGEM
	RE-22008	90 / 90	L-24	2	
	RE-22005	90 / 90	L-24	1	
	RE-22012	90 / 90	L-24	1	USI 10
	RE-22007	90 / 90	H	2	USI 5
	RE-22902	90 / 90	B-53	2	USI 8
	RE-20903	90 / 90	B-53	1	USI 9
	RE-22501	90 / 90	(L-208)/4	4	
	RE-22301	90 / 90	B-53	2	USI 13
	RE-22401	90 / 90	B-53	2	USI 14
	P-639	45 / 45	L-24	2	band.
	P-639	45 / 45	C-12	2	band.
	P-633	90 / 90	C-48	3	band.
	U-1230	90 / 90	(L-159)/4	8	band.
	U-1230	90 / 90	C-72	8	band.
	P-639	45 / 45	L-24	2	peitoril
	P-639	45 / 45	A-17	2	peitoril
	P-633	90 / 90	A-52	3	peitoril
	U-1230	90 / 90	(L-159)/4	8	peitoril
	U-1230	90 / 90	A-76	8	peitoril
	CL-006	90 / 90	21	8	
	CL-011	90 / 90	21	16	

JANELA DE CORRER

4 FOLHAS PARA 2 PLANOS

COM BANDEIRA E PEITORIL FIXO

COMPONENTES				
CROQUI	REF.	QDE.	DESCRIÇÃO	OBS.
	PCP-4832PL	40	Fixação do marco/folha/travessa	
	PCP-3995	$((2*(L+A))/350)+1$	Fixa peitoril	
	PCP-3995	$((2*(L+C))/350)+1$	Fixa bandeira	
	PCP-4219	$(B/350)+1$	Fixa mata junta central	
	VDA-22001	10	Vedação superior e inferior	Ver tabela de componentes
	DRN-22001	3	Dreno	Ver tabela de componentes
	CTF-0001	1	Contra fecho	Ver tabela de componentes
	FCH-0002	1	Fecho concha JANELA	Ver tabela de componentes
	CHC-0001	1	Concha cega JANELA	Ver tabela de componentes
	TRV-22001	1	Lingueta fecho concha	Ver tabela de componentes
	GDE-22001	8	Guia da folha lateral	Ver tabela de componentes
	GDE-22002	8	Guia da folha mão de amigo	Ver tabela de componentes
	RLD-22001	4	Roldana da folha	Ver tabela de componentes
	BTE-0008	4	Batedeira da folha	Ver tabela de componentes
	CAL-0001	4	Calço da folha fixa	Ver tabela de componentes
	TRV-22003	4	Trava da folha fixa	Ver tabela de componentes
	VDA-22005	16	Espuma polietileno fechamento interno	Ver tabela de componentes
	VDA-0011	2	Lã pet isolamento dos rasgos das conchas	Ver tabela de componentes
	P020010	64	Calço do vidro EPDM 6x3x50	Calço do vidro bandeira/peitoril
	ESP-11x4	$(2*(L+B))+2*(L+C)$	Espuma polietileno 11x4	Vedação quadro fixo
	GUA-258	$(2*(L+B))+2*(L+C)$	Espuma PVC 11X4	Esp. vidro 6 mm
	GUA-171	$(6*B)+(6*C)$	Espuma PVC 11x3	Esp. vidro 6 mm coluna

JANELA DE CORRER

4 FOLHAS PARA 2 PLANOS

**COM PERSIANA INTEGRADA
MANUAL**

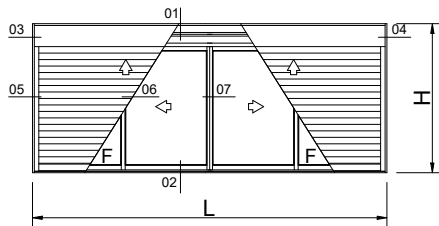

RE22-IJC400

VER COMBINAÇÕES DE PERFIS
NA SESSÃO: DETALHES

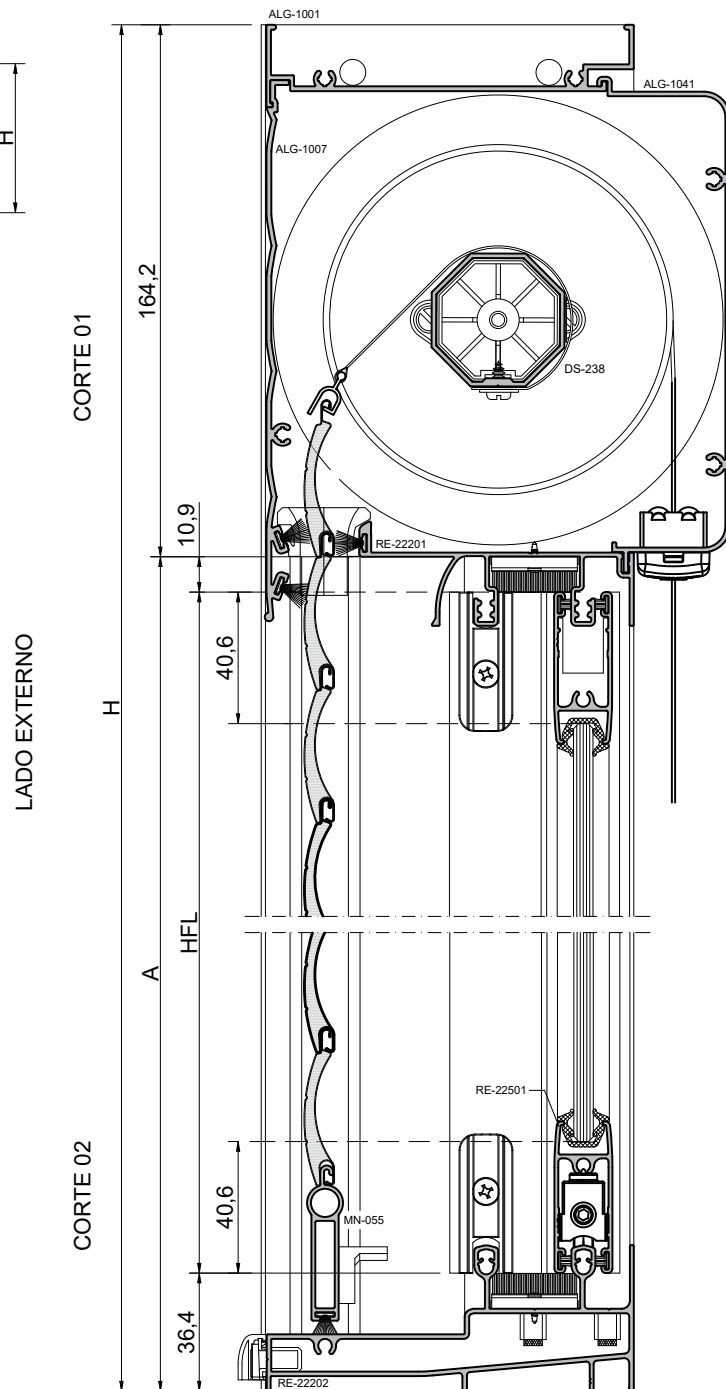

ESC.: 1:2

JANELA DE CORRER
4 FOLHAS PARA 2 PLANOS

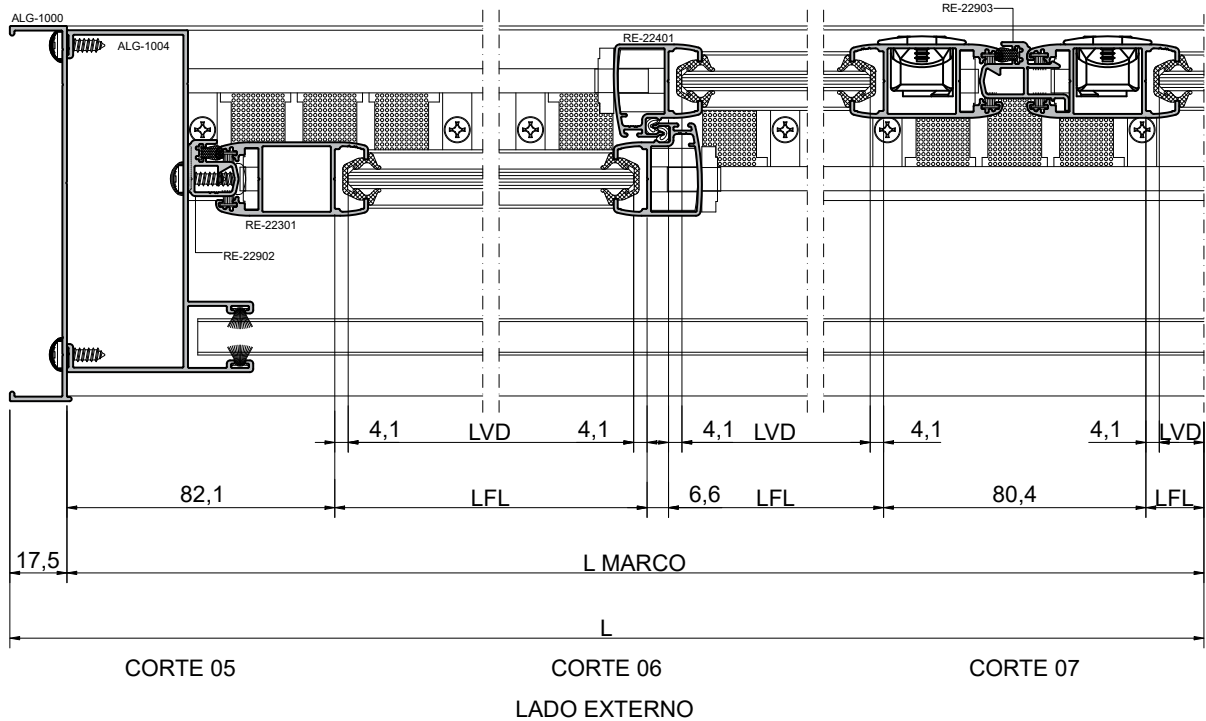
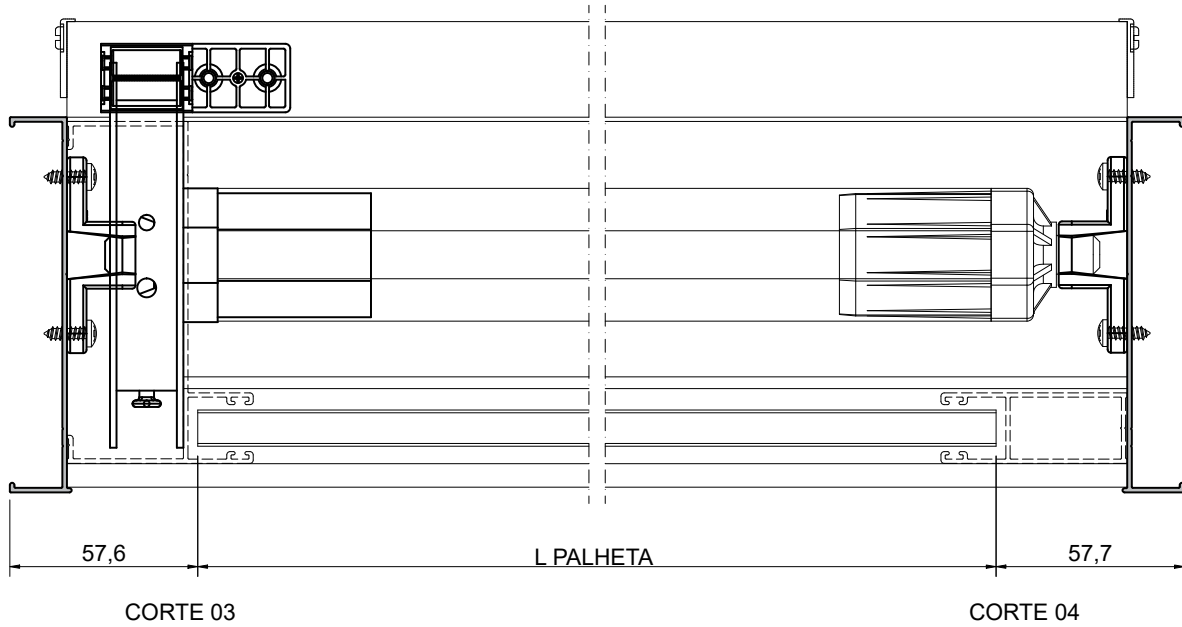

COM PERSIANA INTEGRADA
MANUAL



ESC.: 1:2

JANELA DE CORRER 4 FOLHAS PARA 2 PLANOS

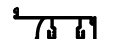
**COM PERSIANA INTEGRADA
MANUAL**

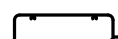
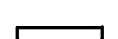
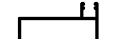
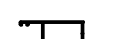
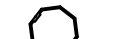
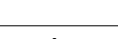
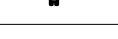
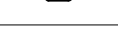
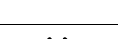
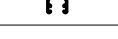
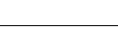
PERFIS					
CROQUI	CÓDIGO	CORTE	TAMANHO	QDE.	USINAGEM
	ALG-1001	90 / 90	L-35	1	
	RE-22201	90 / 90	L-35	1	
	RE-22202	90 / 90	L-35	1	
	ALG-1007	90 / 90	L-35	1	
	ALG-1041	90 / 90	L-35	1	
	ALG-1000	90 / 90	H	2	USI 24
	ALG-1004	90 / 90	A-18	1	USI 22
	ALG-1005	90 / 90	A-18	1	USI 21
	DS-238	90 / 90	variável conforme fornecedor recolhedor	1	
	MN-055	90 / 09	L-115	1	
	RE-22902	90 / 90	A-47	2	USI 8
	RE-22903	90 / 90	A-47	1	USI 9
	RE-22501	90 / 90	(L-256)/4	8	
	RE-22301	90 / 90	A-47	4	USI 13
	RE-22401	90 / 90	A-47	4	USI 14

JANELA DE CORRER

4 FOLHAS PARA 2 PLANOS









COM PERSIANA INTEGRADA MANUAL

COMPONENTES				
CROQUI	REF.	QDE.	DESCRIÇÃO	OBS.
	PCP-4832PL	32	Fixação marco/folha travessa	
	PCP-3995	$((A/350)+1)*2$	Fixa mata junta	
	PCP-4219	$(A/350)+1$	Fixa mata junta central	
	PCP-3995	$((A/350)+1)*3$	Fixa ALG-1004/1005	
	VDA-22001	10	Vedação superior e inferior	Ver tabela de componentes
	DRN-22001	3	Dreno	Ver tabela de componentes
	CTF-0001	2	Contra fecho	Ver tabela de componentes
	FCH-0002	1	Fecho concha JANELA	Ver tabela de componentes
	CHC-0001	1	Concha cega Janela	Ver tabela de componentes
	TRV-22001	2	Lingueta fecho concha	Ver tabela de componentes
	GDE-22001	8	Guia da folha lateral	Ver tabela de componentes
	GDE-22002	8	Guia da folha mão de amigo	Ver tabela de componentes
	RLD-22001	4	Roldana da folha	Ver tabela de componentes
	CAL-0001	4	Calço da folha fixa	Ver tabela de componentes
	TRV-22003	4	Trava da folha fixa	Ver tabela de componentes
	BTE-0008	4	Batedeira da folha	Ver tabela de componentes
	VDA-22005	16	Espuma polietileno fechamento interno	Ver tabela de componentes
	VDA-0011	2	Lã pet isolamento os calços de vedação	Ver tabela de componentes
	GPE-0006	2	Guia da Esteira	Ver tabela de componentes

JANELA DE CORRER

4 FOLHAS PARA 2 PLANOS

COM PERSIANA INTEGRADA MANUAL

COMPONENTES				
CROQUI	REF.	QDE.	DESCRIÇÃO	OBS.
	RCO-0001	1	Recolhedor manual janela	Ver tabela de componentes
	GCT-0003	1	Guia inferior da cinta	Ver tabela de componentes
	FPE-0001	4	Fixador da esteira	Ver tabela de componentes
	LPE-0001	2	Limitador da esteira	Ver tabela de componentes
	TMT-0005	2	Tampa da caixa	Ver tabela de componentes
	DAP-0001	2	Disco alinhador da esteira	Ver tabela de componentes
	PAC-0001	VAR	Palheta cega passo 41mm	Ver tabela de componentes
	PAV-0001	VAR	Palheta ventilada passo 41mm	Ver tabela de componentes

GUARNIÇÕES/ESCOVAS			
CROQUI	CÓDIGO	MEDIDA	DESCRIÇÃO
	QL-5375	2*A	Qlon de vedação
	GXT-1128	(2*L)+(4*A)	Gaxeta p/ vidro 6 mm
	GNC-0001	4*A	Mão de amigo
	ECV-0010B	4*L	Escova 5X4 com barreira plastica
	EVC-0010B	4*A	Escova 5X4 com barreira plastica
	EVC-0001B	2*A	Escova 5X6 com barreira plastica
	GXT-1155	L	Gaxeta trava da tampa
	ECV-0012	3*L	Escova 5X12
	ECV-0004	L	Escova 5X7
	ECV-0006	4*A	Escova 5X8

VIDRO JANELA	
LARGURA	(L-288)/4
ALTURA	A-128

JANELA DE CORRER
4 FOLHAS PARA 2 PLANOS

COM PERSIANA INTEGRADA
MANUAL

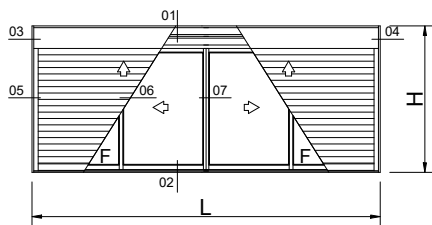

RE22-IJC400

VER COMBINAÇÕES DE PERFIS
 NA SESSÃO: DETALHES

LADO EXTERNO

CORTE 01

CORTE 02

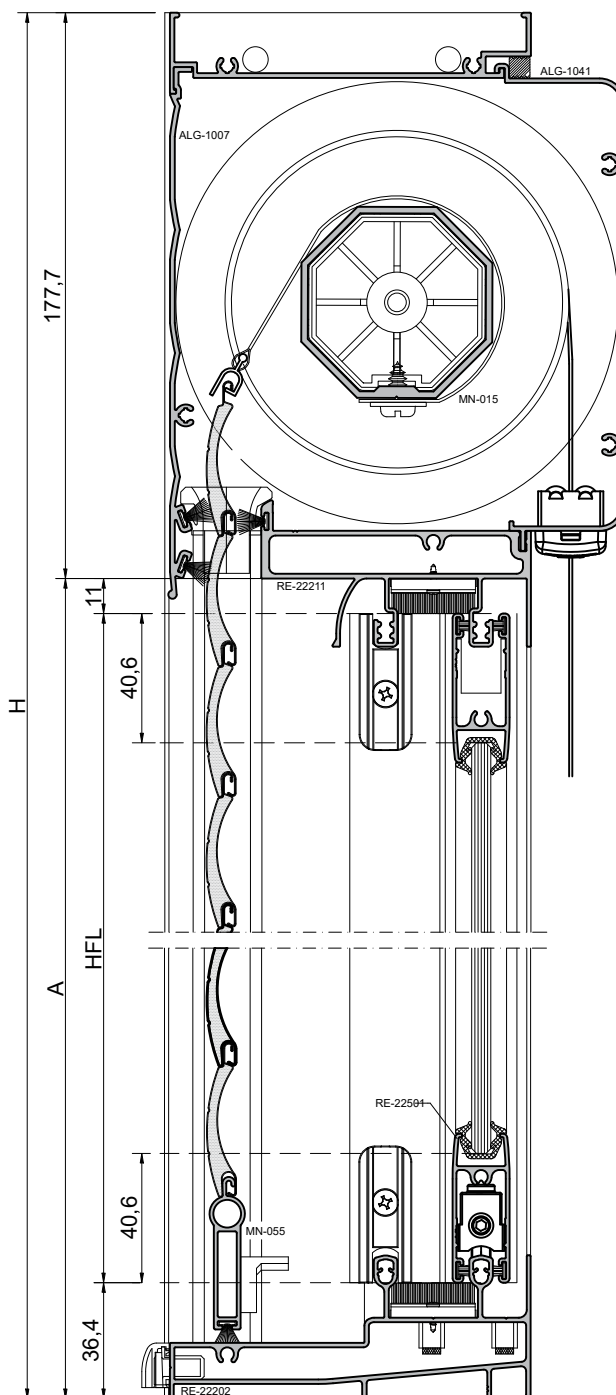

ESC.: 1:2

JANELA DE CORRER

4 FOLHAS PARA 2 PLANOS

**COM PERSIANA INTEGRADA
MANUAL**

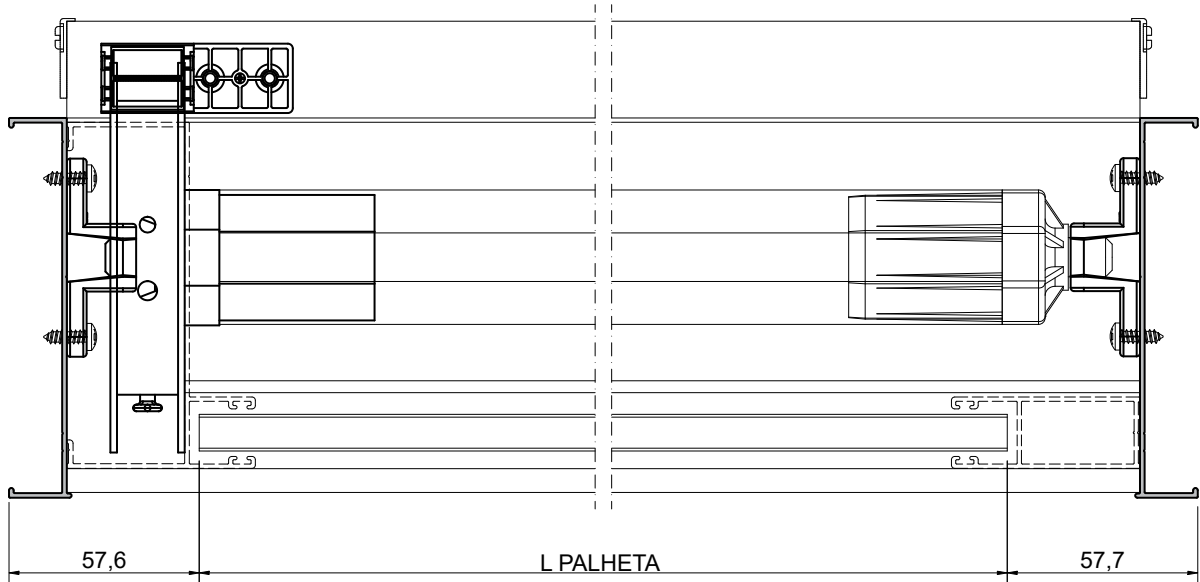

CORTE 03

CORTE 04

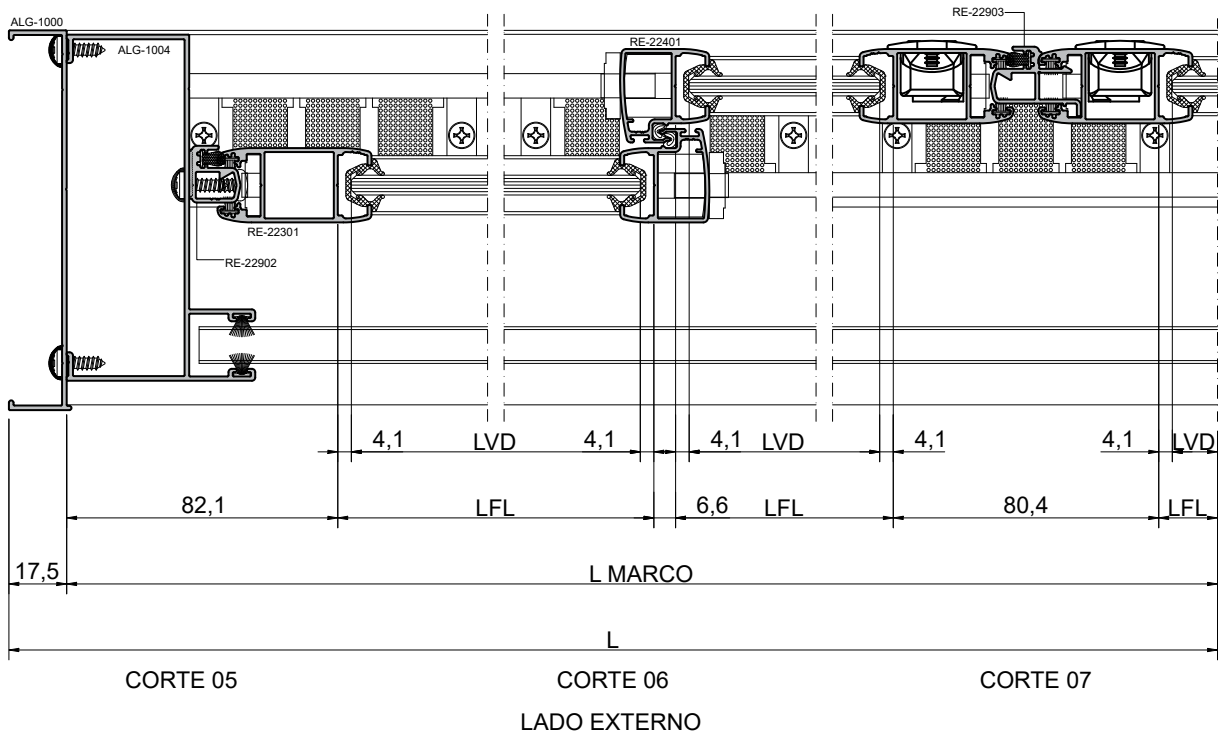

CORTE 05







CORTE 06

CORTE 07

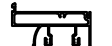
LADO EXTERNO

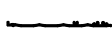
ESC.: 1:2

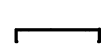
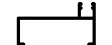
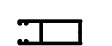
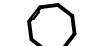
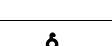
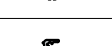
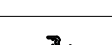
JANELA DE CORRER
4 FOLHAS PARA 2 PLANOS
COM PERSIANA INTEGRADA
MANUAL

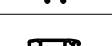
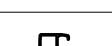
PERFIS					
CROQUI	CÓDIGO	CORTE	TAMANHO	QDE.	USINAGEM
	ALG-1001	90 / 90	L-35	1	
	RE-22211	90 / 90	L-35	1	
	RE-22202	90 / 90	L-35	1	
	ALG-1007	90 / 90	L-35	1	
	ALG-1041	90 / 90	L-35	1	
	ALG-1000	90 / 90	H	2	USI 28
	ALG-1004	90 / 90	H-181	1	USI 23
	ALG-1005	90 / 90	H-181	1	USI 21
	MN-015	90 / 90	variável conforme fornecedor recolhedor	1	
	MN-055	90 / 09	L-115	1	
	RE-22902	90 / 90	A-47	2	USI 8
	RE-22903	90 / 90	A-47	1	USI 9
	RE-22501	90 / 90	(L-256)/4	8	
	RE-22301	90 / 90	A-47	4	USI 13
	RE-22401	90 / 90	A-47	4	USI 14

JANELA DE CORRER









4 FOLHAS PARA 2 PLANOS









COM PERSIANA INTEGRADA MANUAL

COMPONENTES				
CROQUI	REF.	QDE.	DESCRIÇÃO	OBS.
	PCP-4832PL	32	Fixação marco/folha travessa	
	PCP-3995	$((A/350)+1)*3$	Fixa mata junta	
	PCP-4219	$(A/350)+1$	Fixa mata junta central	
	PCP-3995	$((A/350)+1)*3$	Fixa ALG-1004/1005	
	VDA-22001	10	Vedação superior e inferior	Ver tabela de componentes
	DRN-22001	3	Dreno	Ver tabela de componentes
	CTF-0001	2	Contra fecho	Ver tabela de componentes
	FCH-0002	1	Fecho concha JANELA	Ver tabela de componentes
	CHC-0001	1	Concha cega JANELA	Ver tabela de componentes
	TRV-22001	2	Lingueta fecho concha	Ver tabela de componentes
	GDE-22001	8	Guia da folha lateral	Ver tabela de componentes
	GDE-22002	8	Guia da folha mão de amigo	Ver tabela de componentes
	RLD-22001	4	Roldana da folha	Ver tabela de componentes
	CAL-0001	4	Calço da folha fixa	Ver tabela de componentes
	TRV-22003	4	Trava da folha fixa	Ver tabela de componentes
	BTE-0008	4	Batedeira da folha	Ver tabela de componentes
	VDA-22005	16	Espuma polietileno fechamento interno	Ver tabela de componentes
	VDA-0011	2	Lã pet isolamento os calços de vedação	Ver tabela de componentes
	GPE-0006	2	Guia da Esteira	Ver tabela de componentes

JANELA DE CORRER
4 FOLHAS PARA 2 PLANOS

COM PERSIANA INTEGRADA
MANUAL

COMPONENTES				
CROQUI	REF.	QDE.	DESCRIÇÃO	OBS.
	RCO-0001	1	Recolhedor manual janela	Ver tabela de componentes
	GCT-0003	1	Guia inferior da cinta	Ver tabela de componentes
	FPE-0001	4	Fixador da esteira	Ver tabela de componentes
	LPE-0001	2	Limitador da esteira	Ver tabela de componentes
	TMT-0005	2	Tampa da caixa	Ver tabela de componentes
	DAP-0001	2	Disco alinhador da esteira	Ver tabela de componentes
	PAC-0001	VAR.	Palheta cega passo 41mm	Ver tabela de componentes
	PAV-0001	VAR.	Palheta ventilada passo 41mm	Ver tabela de componentes

GUARNIÇÕES/ESCOVAS			
CROQUI	CÓDIGO	MEDIDA	DESCRIÇÃO
	QL-5375	2*A	Qlon de vedação
	GXT-1128	(2*L)+(4*A)	Gaxeta p/ vidro 6 mm
	GNC-0001	4*A	Mão de amigo
	ECV-0010B	4*L	Escova 5X4 com barreira plastica
	EVC-0010B	4*A	Escova 5X4 com barreira plastica
	EVC-0001B	2*A	Escova 5X6 com barreira plastica
	GXT-1155	L	Gaxeta trava da tampa
	ECV-0012	3*L	Escova 5X12
	ECV-0004	L	Escova 5X7
	ECV-0006	4*A	Escova 5X8

VIDRO JANELA	
LARGURA	(L-288)/4
ALTURA	A-129

JANELA DE CORRER

4 FOLHAS PARA 2 PLANOS

COM PERSIANA INTEGRADA
COM MOTOR

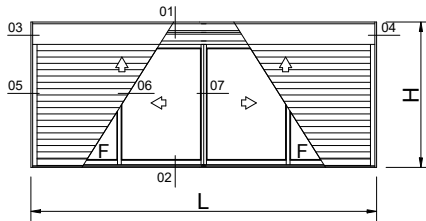

RE22-IJC400

VER COMBINAÇÕES DE PERFIS
NA SESSÃO: DETALHES

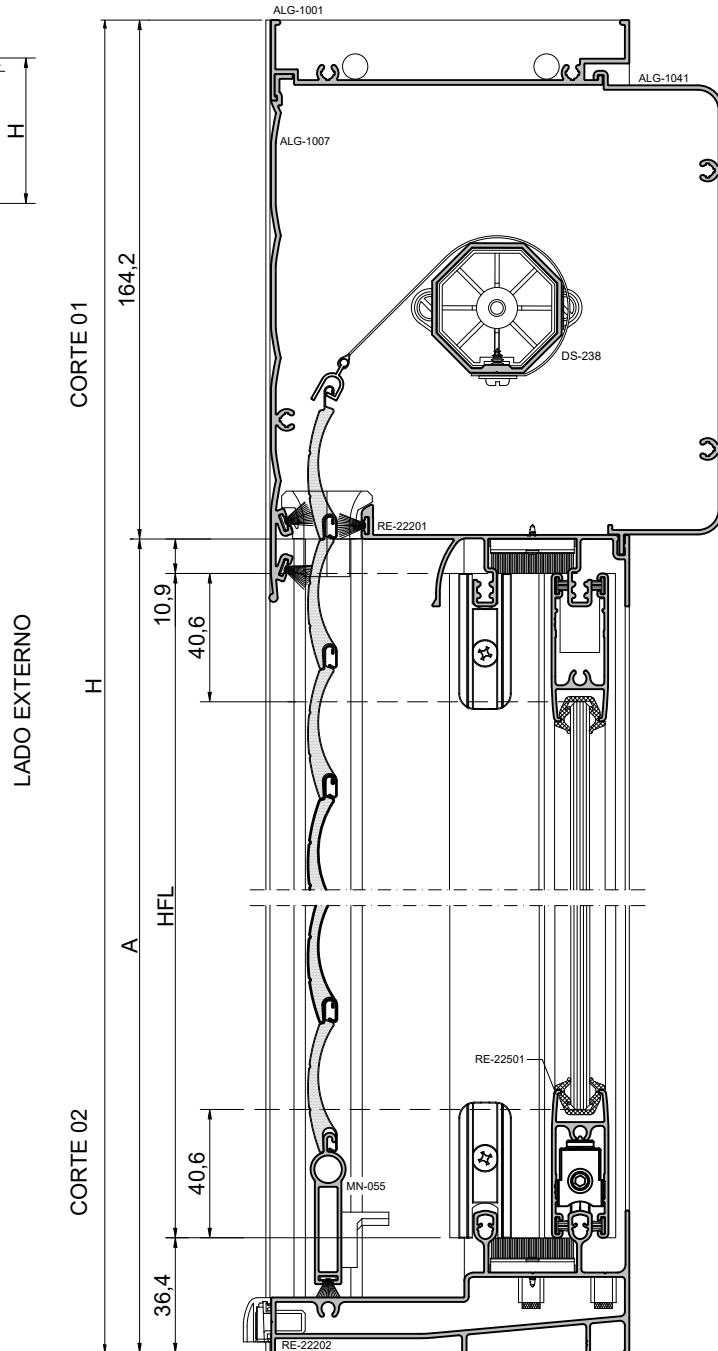

ESC.: 1:2

JANELA DE CORRER
4 FOLHAS PARA 2 PLANOS



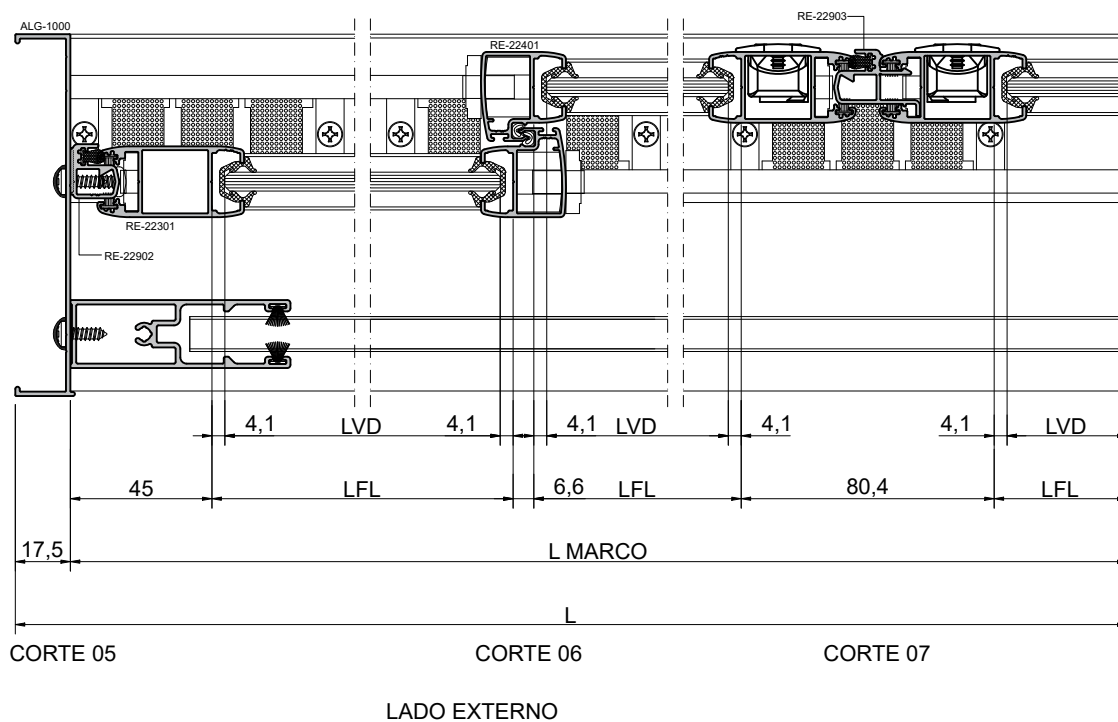
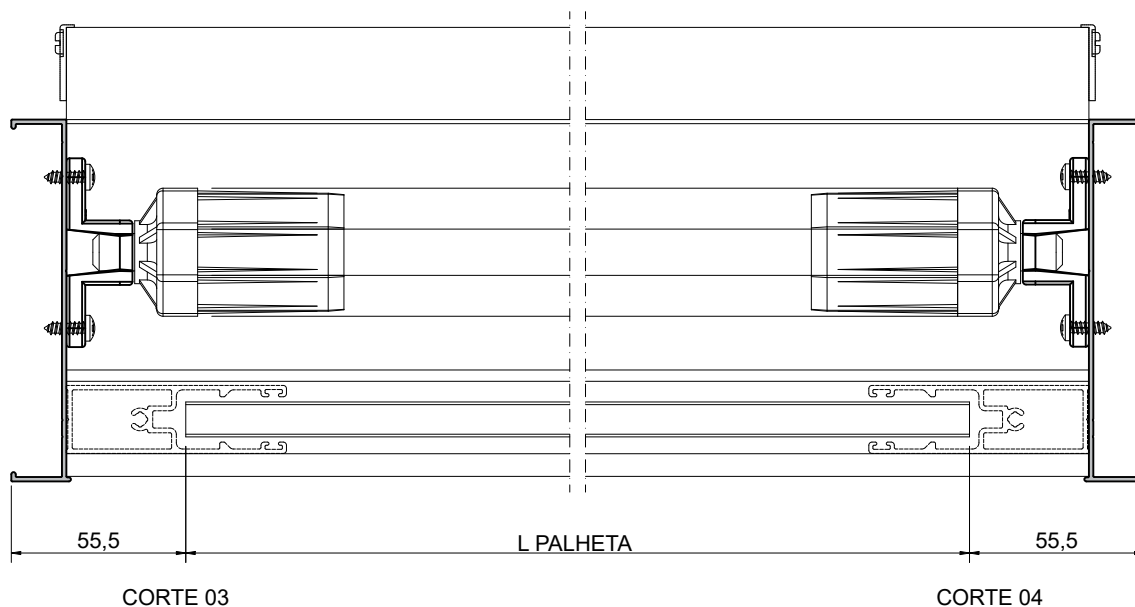







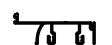

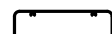
COM PERSIANA INTEGRADA
MANUAL

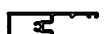

ESC.: 1:2

JANELA DE CORRER 4 FOLHAS PARA 2 PLANOS

COM PERSIANA INTEGRADA MANUAL







PERFIS					
CROQUI	CÓDIGO	CORTE	TAMANHO	QDE.	USINAGEM
	ALG-1001	90 / 90	L-35	1	
	RE-22201	90 / 90	L-35	1	
	RE-22202	90 / 90	L-35	1	
	ALG-1007	90 / 90	L-35	1	
	ALG-1041	90 / 90	L-35	1	
	ALG-1000	90 / 90	H	2	USI 24
	ALG-1013	90 / 90	A-18	2	USI 21
	DS-238	90 / 90	variável conforme fornecedor recolhedor	1	
	MN-055	90 / 09	L-111	1	
	RE-22902	90 / 90	A-47	2	USI 8
	RE-22903	90 / 90	A-47	1	USI 9
	RE-22501	90 / 90	(L-219)/4	8	
	RE-22301	90 / 90	A-47	4	USI 13
	RE-22401	90 / 90	A-47	4	USI 14

JANELA DE CORRER
4 FOLHAS PARA 2 PLANOS
COM PERSIANA INTEGRADA
MANUAL

COMPONENTES				
CROQUI	REF.	QDE.	DESCRIÇÃO	OBS.
	PCP-4832PL	32	Fixação marco/folha travessa	
	PCP-3995	$((A/350)+1)*2$	Fixa mata junta	
	PCP-4219	$(A/350)+1$	Fixa mata junta central	
	PCP-3995	$((A/350)+1)*2$	Fixa ALG-1004/1005	
	VDA-22001	10	Vedação superior e inferior	Ver tabela de componentes
	DRN-22001	3	Dreno	Ver tabela de componentes
	CTF-0001	2	Contra fecho	Ver tabela de componentes
	FCH-0002	1	Fecho concha JANELA	Ver tabela de componentes
	CHC-0001	1	Concha cega JANELA	Ver tabela de componentes
	TRV-22001	2	Lingueta fecho concha	Ver tabela de componentes
	GDE-22001	8	Guia da folha lateral	Ver tabela de componentes
	GDE-22002	8	Guia da folha mão de amigo	Ver tabela de componentes
	RLD-22001	4	Roldana da folha	Ver tabela de componentes
	CAL-0001	4	Calço da folha fixa	Ver tabela de componentes
	TRV-22003	4	Trava da folha fixa	Ver tabela de componentes
	BTE-0008	4	Batedeira da folha	Ver tabela de componentes
	VDA-22005	16	Espuma polietileno fechamento interno	Ver tabela de componentes
	VDA-0011	2	Lã pet isolamento os calços de vedação	Ver tabela de componentes
	GPE-0006	2	Guia da Esteira	Ver tabela de componentes

JANELA DE CORRER 4 FOLHAS PARA 2 PLANOS

COM PERSIANA INTEGRADA MANUAL

COMPONENTES				
CROQUI	REF.	QDE.	DESCRIÇÃO	OBS.
	FPE-0001	4	Fixador da esteira	Ver tabela de componentes
	LPE-0001	2	Limitador da esteira	Ver tabela de componentes
	TMT-0007	2	Tampa da caixa	Ver tabela de componentes
	DAP-0001	2	Disco alinhador da esteira	Ver tabela de componentes
	PAC-0001	VAR	Palheta cega passo 41mm	Ver tabela de componentes
	PAV-0001	VAR	Palheta ventilada passo 41mm	Ver tabela de componentes

GUARNIÇÕES/ESCOVAS			
CROQUI	CÓDIGO	MEDIDA	DESCRIÇÃO
	QL-5375	2*A	Qlon de vedação
	GXT-1128	(2*L)+(4*A)	Gaxeta p/ vidro 6 mm
	GNC-0001	4*A	Mão de amigo
	ECV-0010B	4*L	Escova 5X4 com barreira plastica
	EVC-0010B	4*A	Escova 5X4 com barreira plastica
	EVC-0001B	2*A	Escova 5X6 com barreira plastica
	GXT-1155	L	Gaxeta trava da tampa
	ECV-0012	3*L	Escova 5X12
	ECV-0004	L	Escova 5X7
	ECV-0006	4*A	Escova 5X8

VIDRO JANELA	
LARGURA	(L-251)/4
ALTURA	A-128

JANELA DE CORRER
4 FOLHAS PARA 2 PLANOS

COM PERSIANA INTEGRADA
COM MOTOR

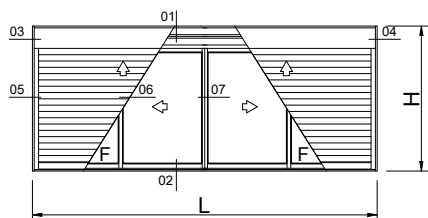

RE22-IJC400

VER COMBINAÇÕES DE PERFIS
NA SESSÃO: DETALHES

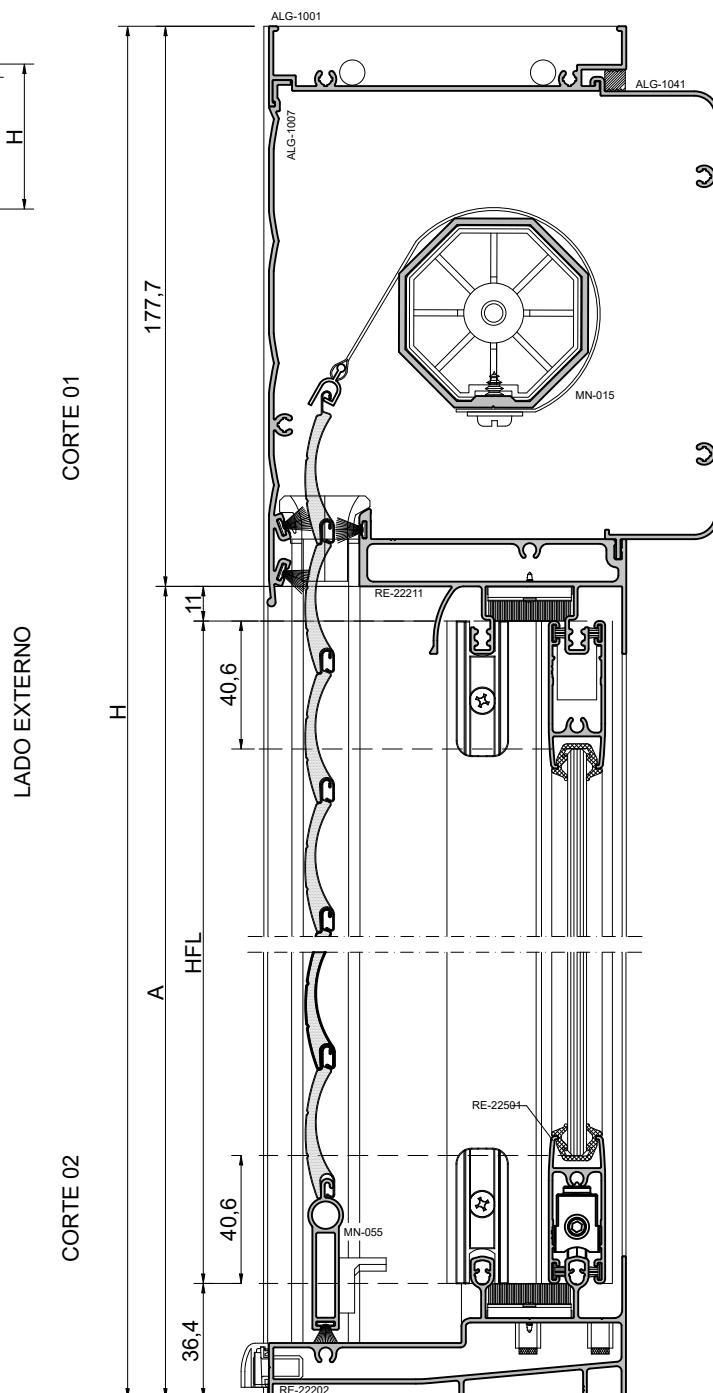

ESC.: 1:2

JANELA DE CORRER

4 FOLHAS PARA 2 PLANOS

COM PERSIANA INTEGRADA
COM MOTOR

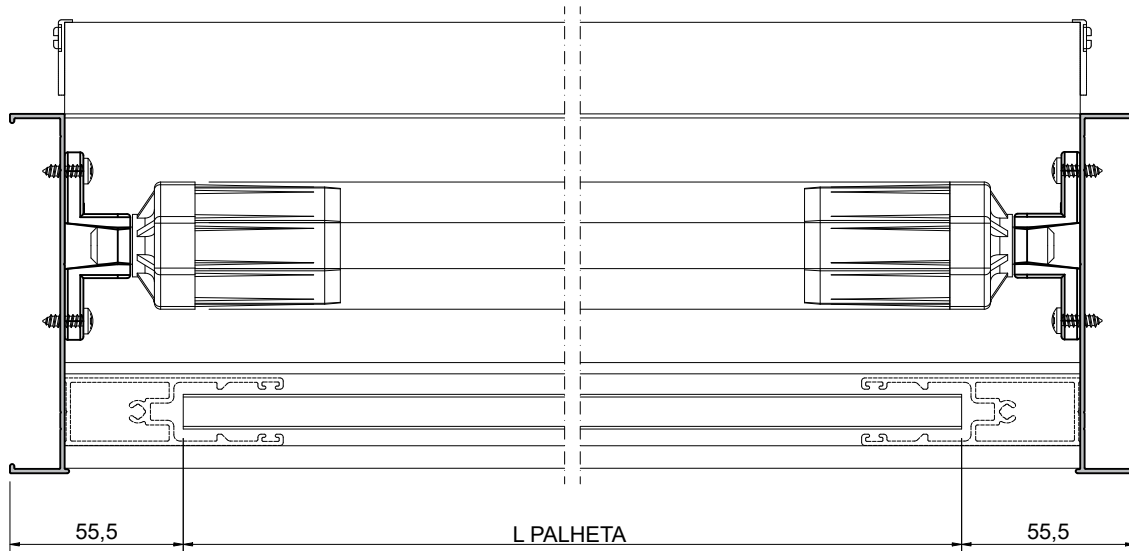

CORTE 03

CORTE 04

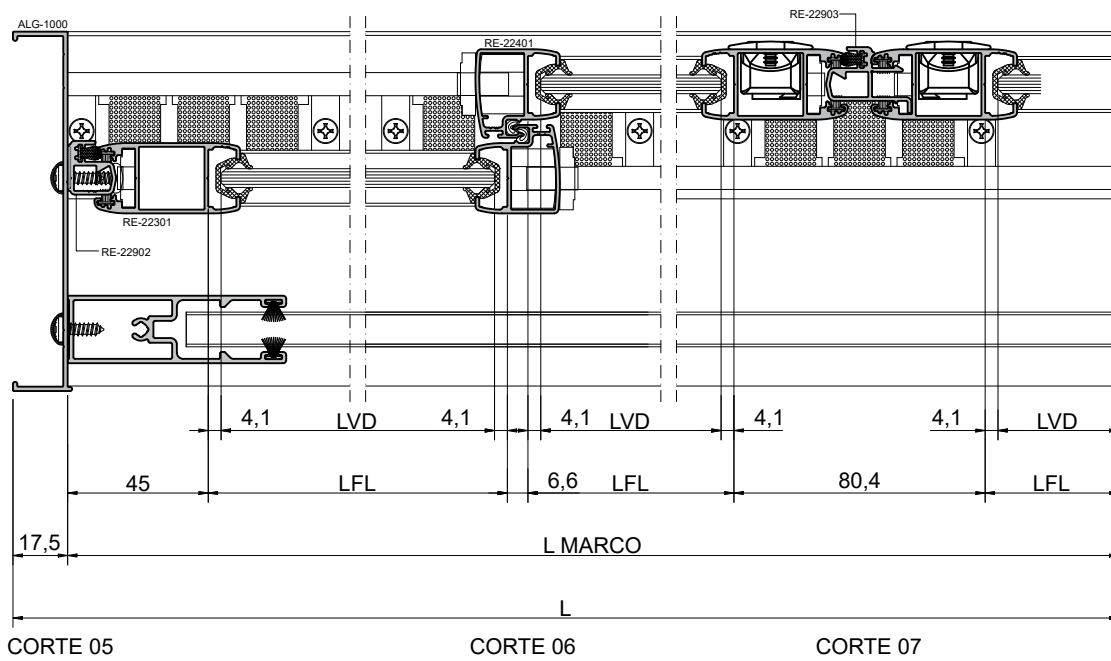

CORTE 05











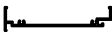

CORTE 06

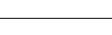
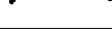
CORTE 07

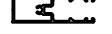
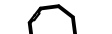
LADO EXTERNO

ESC.: 1:2

JANELA DE CORRER
4 FOLHAS PARA 2 PLANOS
COM PERSIANA INTEGRADA
COM MOTOR

PERFIS					
CROQUI	CÓDIGO	CORTE	TAMANHO	QDE.	USINAGEM
	ALG-1001	90 / 90	L-35	1	
	RE-22211	90 / 90	L-35	1	
	RE-22202	90 / 90	L-35	1	
	ALG-1007	90 / 90	L-35	1	
	ALG-1041	90 / 90	L-35	1	
	ALG-1000	90 / 90	H	2	USI 28
	ALG-1003	90 / 90	H-181	2	USI 21
	MN-015	90 / 90	variável conforme fornecedor recolhedor	1	
	MN-055	90 / 09	L-115	1	
	RE-22902	90 / 90	A-47	2	USI 8
	RE-22903	90 / 90	A-47	1	USI 9
	RE-22501	90 / 90	(L-219)/4	8	
	RE-22301	90 / 90	A-47	4	USI 13
	RE-22401	90 / 90	A-47	4	USI 14

JANELA DE CORRER







4 FOLHAS PARA 2 PLANOS

COM PERSIANA INTEGRADA COM MOTOR

COMPONENTES				
CROQUI	REF.	QDE.	DESCRIÇÃO	OBS.
	PCP-4832PL	32	Fixação marco/folha travessa	
	PCP-3995	$((A/350)+1)*2$	Fixa mata junta	
	PCP-4219	$(A/350)+1$	Fixa mata junta central	
	PCP-3995	$((A/350)+1)*2$	Fixa ALG-1004/1005	
	VDA-22001	10	Vedação superior e inferior	Ver tabela de componentes
	DRN-22001	3	Dreno	Ver tabela de componentes
	CTF-0001	2	Contra fecho	Ver tabela de componentes
	FCH-0002	1	Fecho concha JANELA	Ver tabela de componentes
	CHC-0001	1	Concha cega JANELA	Ver tabela de componentes
	TRV-22001	2	Lingueta fecho concha	Ver tabela de componentes
	GDE-22001	8	Guia da folha lateral	Ver tabela de componentes
	GDE-22002	8	Guia da folha mão de amigo	Ver tabela de componentes
	RLD-22001	4	Roldana da folha	Ver tabela de componentes
	CAL-0001	4	Calço da folha fixa	Ver tabela de componentes
	TRV-22003	4	Trava da folha fixa	Ver tabela de componentes
	BTE-0008	4	Batedeira da folha	Ver tabela de componentes
	VDA-22005	16	Espuma polietileno fechamento interno	Ver tabela de componentes
	VDA-0011	2	Lã pet isolamento os calços de vedação	Ver tabela de componentes
	GPE-0006	2	Guia da Esteira	Ver tabela de componentes

JANELA DE CORRER
4 FOLHAS PARA 2 PLANOS

COM PERSIANA INTEGRADA
COM MOTOR

COMPONENTES				
CROQUI	REF.	QDE.	DESCRIÇÃO	OBS.
	FPE-0001	4	Fixador da esteira	Ver tabela de componentes
	LPE-0001	2	Limitador da esteira	Ver tabela de componentes
	TMT-0007	2	Tampa da caixa	Ver tabela de componentes
	DAP-0001	2	Disco alinhador da esteira	Ver tabela de componentes
	PAC-0001	VAR	Palheta cega passo 41mm	Ver tabela de componentes
	PAV-0001	VAR	Palheta ventilada passo 41mm	Ver tabela de componentes

GUARNIÇÕES/ESCOVAS			
CROQUI	CÓDIGO	MEDIDA	DESCRIÇÃO
	QL-5375	2*A	Qlon de vedação
	GXT-1128	(2*L)+(4*A)	Gaxeta p/ vidro 6 mm
	GNC-0001	4*A	Mão de amigo
	ECV-0010B	4*L	Escova 5X4 com barreira plastica
	EVC-0010B	4*A	Escova 5X4 com barreira plastica
	EVC-0001B	2*A	Escova 5X6 com barreira plastica
	GXT-1155	L	Gaxeta trava da tampa
	ECV-0012	3*L	Escova 5X12
	ECV-0004	L	Escova 5X7
	ECV-0006	4*A	Escova 5X8

VIDRO JANELA	
LARGURA	(L-251)/4
ALTURA	A-129

JANELA DE CORRER

3 FOLHAS PARA 3 PLANOS

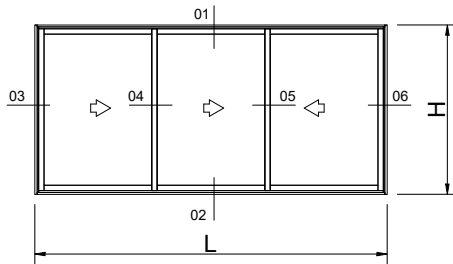

RE22-JCR300

VER COMBINAÇÕES DE PERFIS
NA SESSÃO: DETALHES

LADO EXTERNO

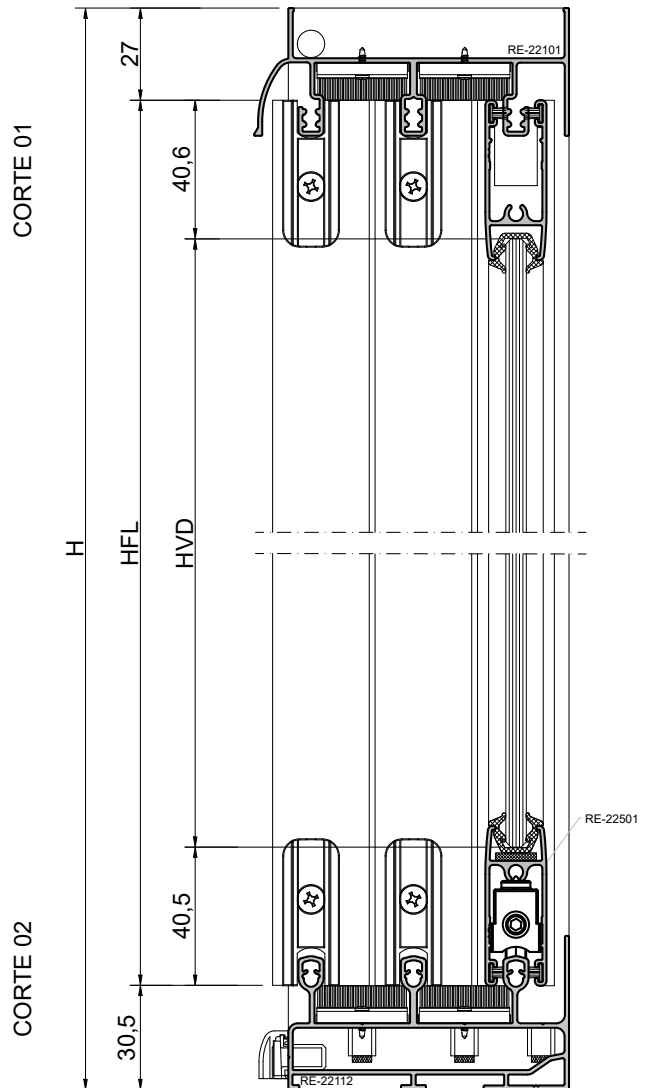

CORTE 02

CORTE 01



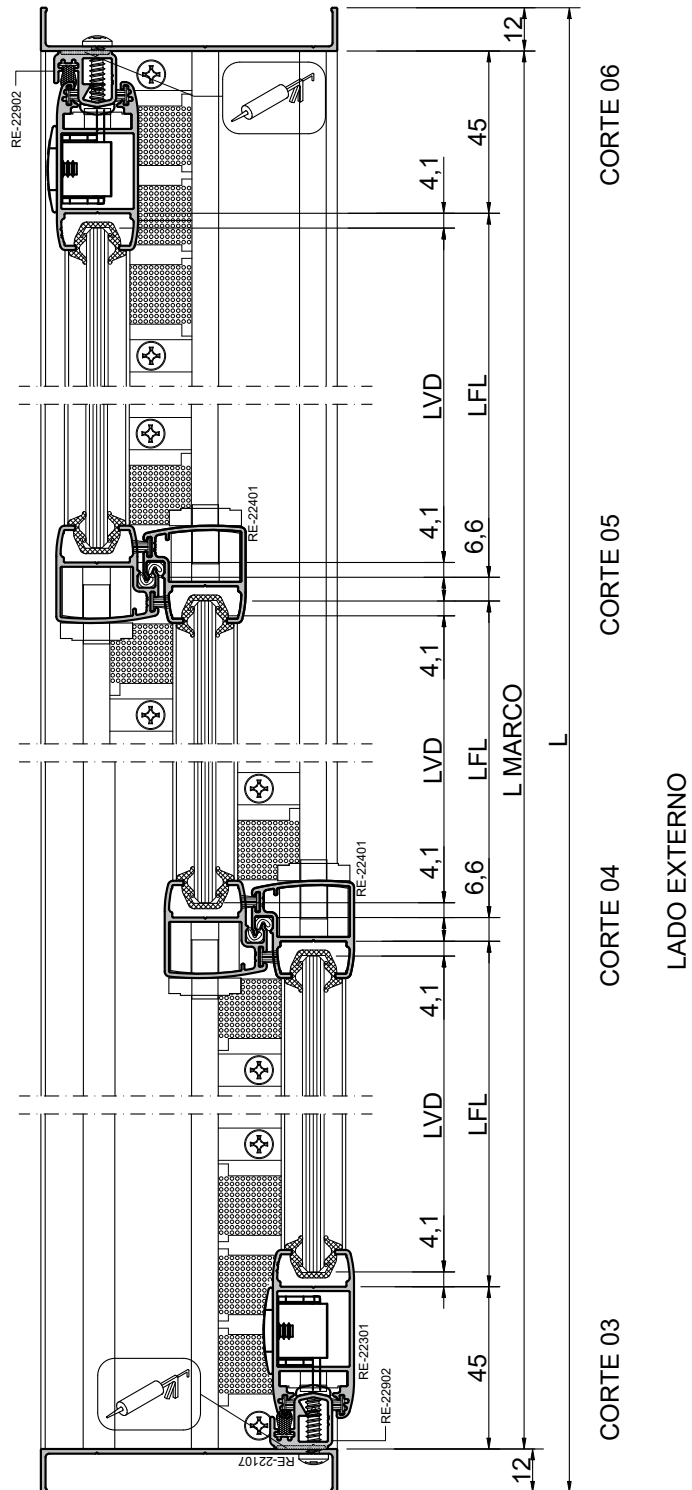



JANELA DE CORRER
3 FOLHAS PARA 3 PLANOS



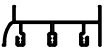





ESC.: 1:2

JANELA DE CORRER

3 FOLHAS PARA 3 PLANOS

PERFIS					
CROQUI	CÓDIGO	CORTE	TAMANHO	QDE.	USINAGEM
	RE-22101	90 / 90	L-24	1	
	RE-22112	90 / 90	L-24	1	USI 12
	RE-22107	90 / 90	H	2	USI 7
	RE-22902	90 / 90	H-57	2	USI 8
	RE-22501	90 / 90	(L-127) / 3	6	
	RE-22301	90 / 90	H-57	2	USI 13
	22401	90 / 90	H-57	4	USI 14

GUARNIÇÕES/ESCOVAS			
CROQUI	CÓDIGO	MEDIDA	DESCRIÇÃO
	QL-5375	2*H	Qlon de vedação
	GXT-1128	(2*L)+(6*H)	Gaxeta p/ vidro 6 mm
	GNC-0001	4*H	Mão de amigo
	ECV-0010B	4*L	Escova 5X4 com barreira plastica
	EVC-0010B	4*H	Escova 5X4 com barreira plastica
	EVC-0001B	4*H	Escova 5X6 com barreira plastica

VIDRO JANELA	
LARGURA	(L-152)/3
ALTURA	H-139

JANELA DE CORRER
3 FOLHAS PARA 3 PLANOS

COMPONENTES				
CROQUI	REF.	QDE.	DESCRIÇÃO	OBS.
	PCP-4832PL	24	Fixação do marco/folha	
	PCP-3995	$((H/350)+1)*2$	Fixar mata junta	
	VDA-22001	8	Vedação superior e inferior	Ver tabela de componentes
	DRN-22001	3	Dreno	Ver tabela de componentes
	CTF-0001	2	Contra fecho	Ver tabela de componentes
	FCH-0002	2	Fecho concha JANELA	Ver tabela de componentes
	TRV-22001	2	Lingueta fecho concha	Ver tabela de componentes
	GDE-22001	4	Guia da folha lateral	Ver tabela de componentes
	GDE-22002	8	Guia da folha mão de amigo	Ver tabela de componentes
	RLD-22001	6	Roldana da folha	Ver tabela de componentes
	BTE-0008	6	Batedeira da folha	Ver tabela de componentes
	VDA-22005	12	Espuma polietileno fechamento interno	Ver tabela de componentes
	VDA-0011	2	Lã pet isolamento dos rasgos das conchas	Ver tabela de componentes

JANELA DE CORRER 3 FOLHAS PARA 3 PLANOS

COM BANDEIRA FIXA

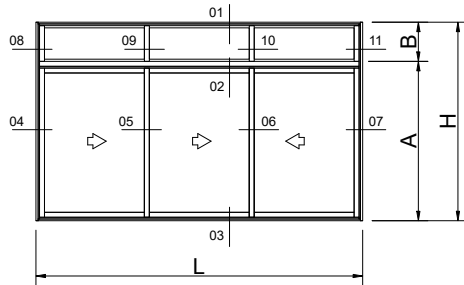

RE22-JCR301

VER COMBINAÇÕES DE PERFIS
NA SESSÃO: DETALHES

LADO EXTERNO

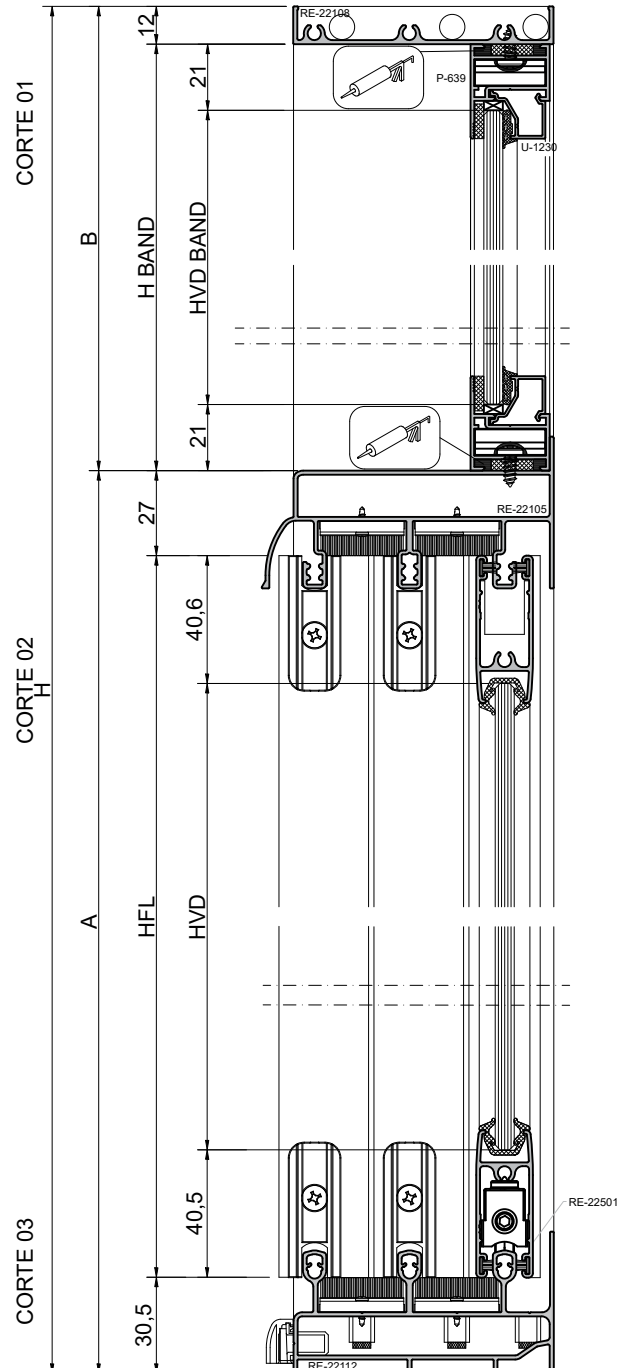

ESC.: 1:2

JANELA DE CORRER
3 FOLHAS PARA 3 PLANOS

COM BANDEIRA FIXA

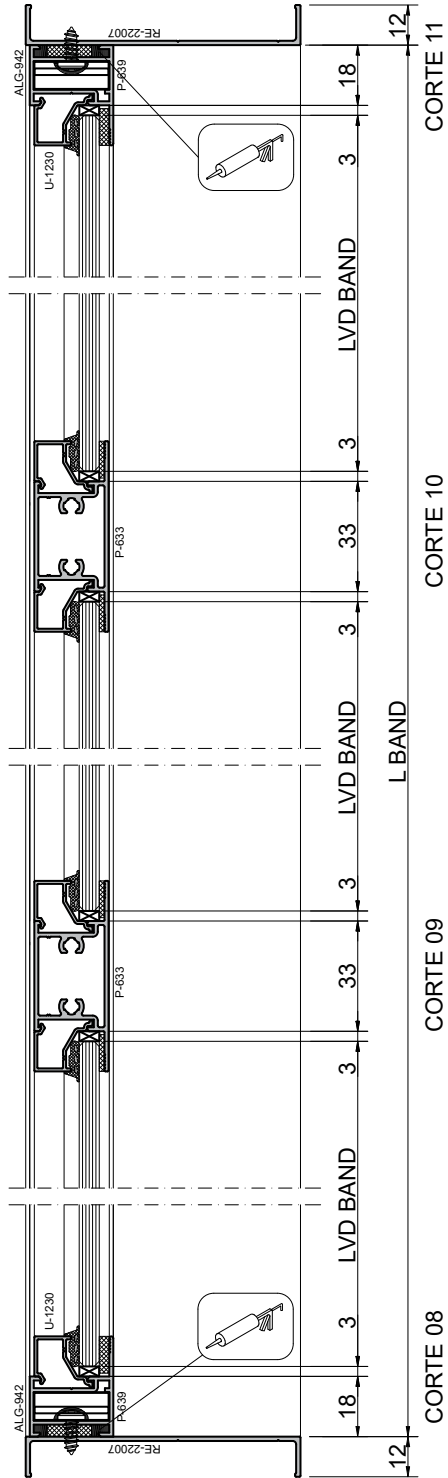

ESC.: 1:2

LADO EXTERNO

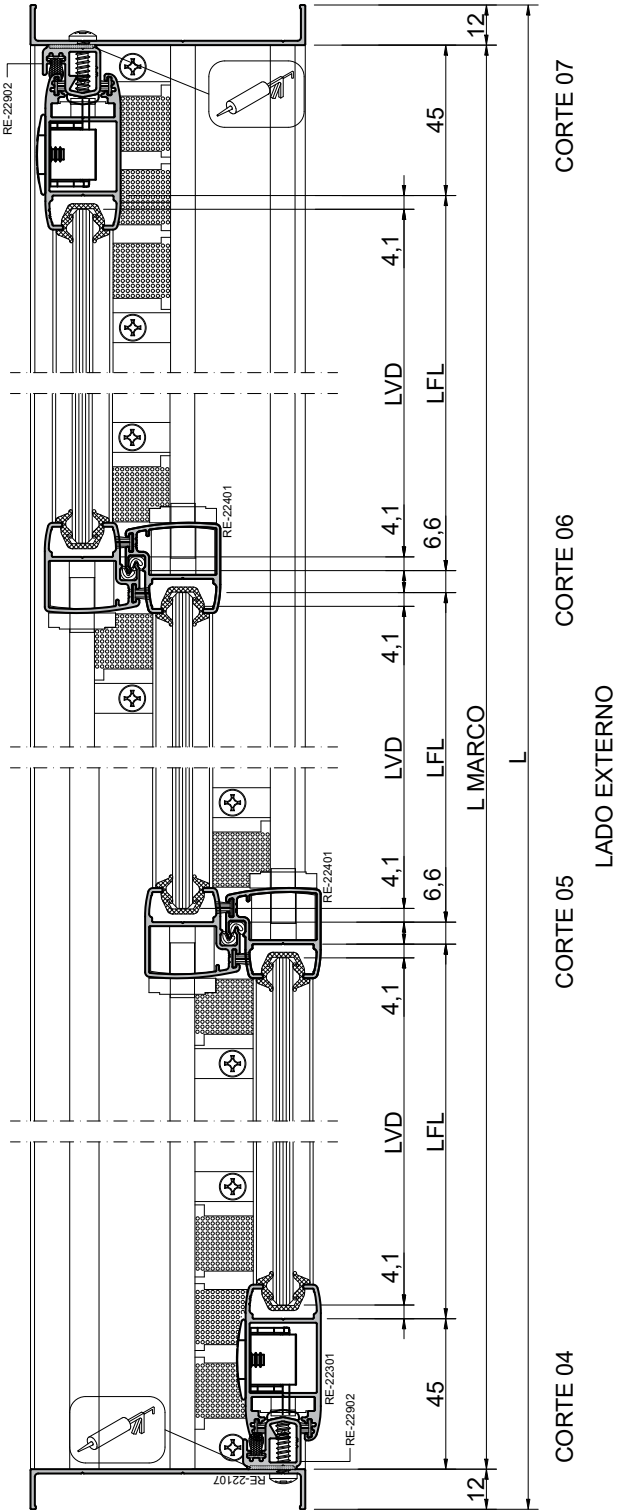















LADO EXTERNO

ESC.: 1:2

JANELA DE CORRER 3 FOLHAS PARA 3 PLANOS

COM BANDEIRA FIXA

PERFIS					
CROQUI	CÓDIGO	CORTE	TAMANHO	QDE.	USINAGEM
	RE-22108	90 / 09	L-24	1	
	RE-22105	90 / 90	L-24	1	
	RE-22112	90 / 90	L-24	1	USI 12
	RE-22107	90 / 90	H	2	USI 6
	RE-22902	90 / 90	A-57	2	USI 8
	RE-22501	90 / 90	(L-127) / 3	6	
	RE-22301	90 / 90	A-57	2	USI 13
	22401	90 / 90	A-57	4	USI 14
	P-639	45 / 45	L-24	2	
	P-639	45 / 45	B-12	2	
	P-633	90 / 90	B-48	2	
	U-1230	90 / 90	(L-126)/3	6	
	U-1230	90 / 90	B-72	6	
	CL-006	90 / 90	21	4	
	CL-011	90 / 90	21	8	

GUARNIÇÕES/ESCOVAS			
CROQUI	CÓDIGO	MEDIDA	DESCRIÇÃO
	QL-5375	2*A	Qlon de vedação
	GXT-1128	(2*L)+(6*A)	Gaxeta p/ vidro 6 mm
	GNC-0001	4*A	Mão de amigo
	ECV-0010B	2*L	Escova 5X4 com barreira plastica
	EVC-0010B	6*H	Escova 5X4 com barreira plastica
	EVC-0001B	2*H	Escova 5X6 com barreira plastica
	GUA-259	(2*L)+(6*B)	Gaxeta de EPDM interna vidro 6mm

VIDRO JANELA	
LARGURA	(L-152)/3
ALTURA	H-139

VIDRO BANDEIRA	
LARGURA	(L-144)/3
ALTURA	B-54

JANELA DE CORRER
3 FOLHAS PARA 3 PLANOS
COM BANDEIRA FIXA

COMPONENTES				
CROQUI	REF.	QDE.	DESCRIÇÃO	OBS.
	PCP-4832PL	38	Fixação do marco/folha	
	PCP-3995	$((A/350)+1)*2$	Fixa mata junta	
	PCP-3995	$((2*(L+B))/350)+1$	Fixa bandeira	
	VDA-22001	8	Vedação superior e inferior	Ver tabela de componentes
	DRN-22001	3	Dreno	Ver tabela de componentes
	CTF-0001	2	Contra fecho	Ver tabela de componentes
	FCH-0002	2	Fecho concha JANELA	Ver tabela de componentes
	TRV-22001	2	Lingueta fecho concha	Ver tabela de componentes
	GDE-22001	4	Guia da folha lateral	Ver tabela de componentes
	GDE-22002	8	Guia da folha mão de amigo	Ver tabela de componentes
	RLD-22001	6	Roldana da folha	Ver tabela de componentes
	BTE-0008	6	Batedeira da folha	Ver tabela de componentes
	VDA-22005	12	Espuma polietileno fechamento interno	Ver tabela de componentes
	VDA-0011	2	Lã pet isolamento dos rasgos das conchas	Ver tabela de componentes
	P020010	24	Calço do vidro EPDM 6x3x50	Calço do vidro bandeira
	ESP-11x4	$(2*(L+B))$	Espuma polietileno 11x4	Vedação quadro fixo
	GUA-258	$(2*(L+B))$	Espuma PVC 11X4	Esp. vidro 6 mm
	GUA-171	4*B	Espuma PVC 11x3	Esp. vidro 6 mm coluna

JANELA DE CORRER

3 FOLHAS PARA 3 PLANOS

COM PEITORIL FIXO

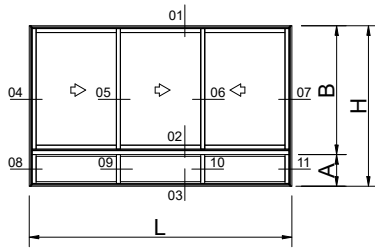

RE22-JCR302

VER COMBINAÇÕES DE PERFIS
NA SESSÃO: DETALHES

LADO EXTERNO

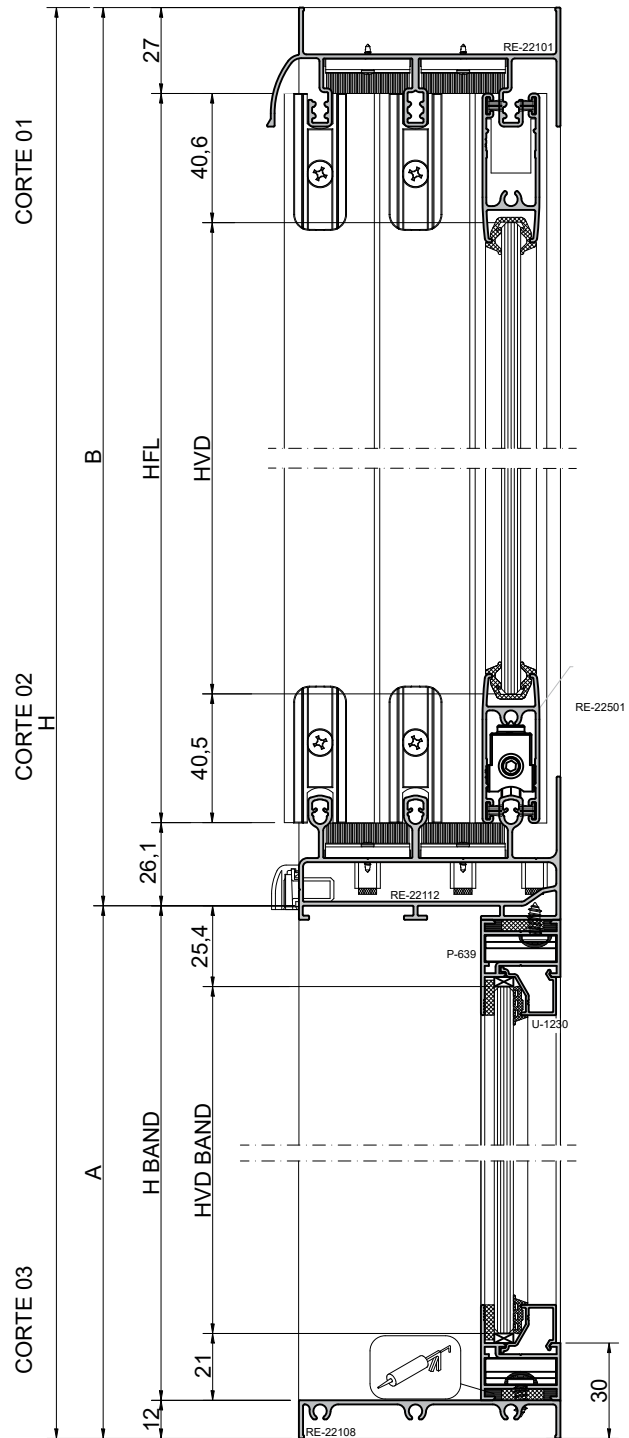

ESC.: 1:2





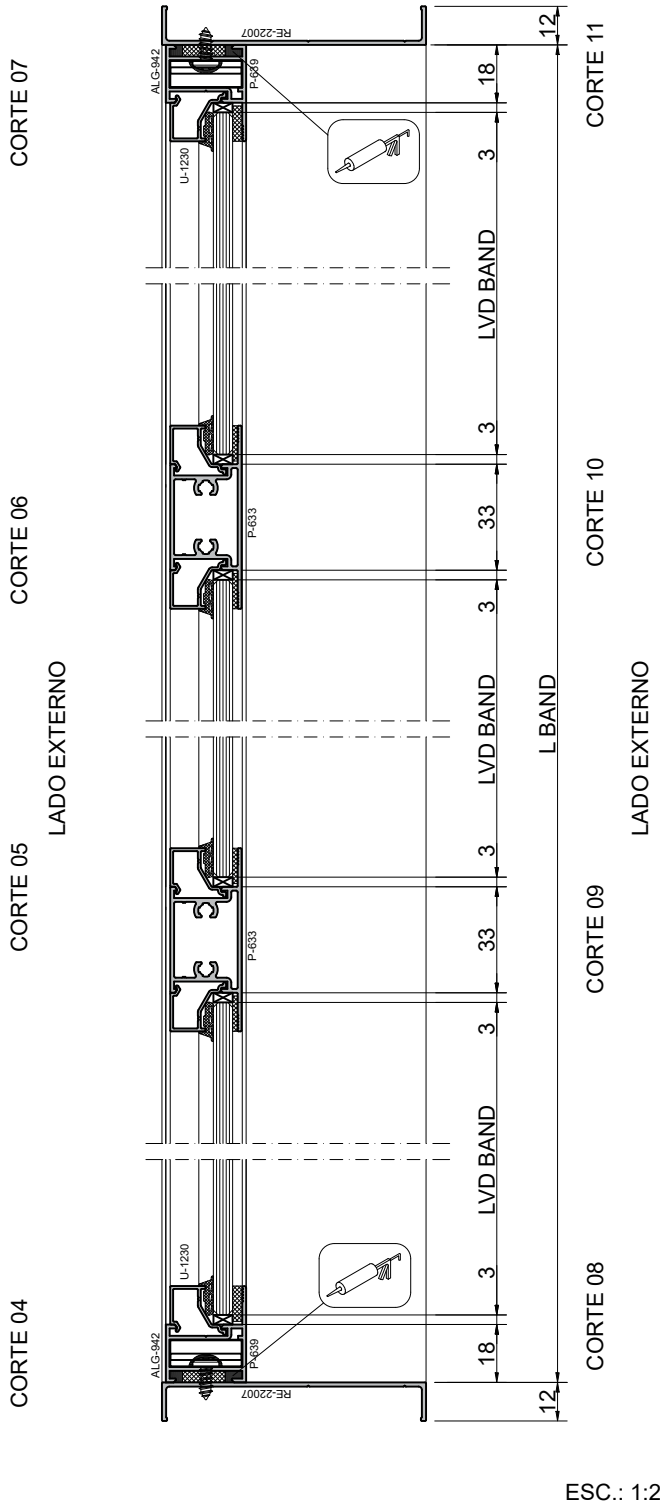
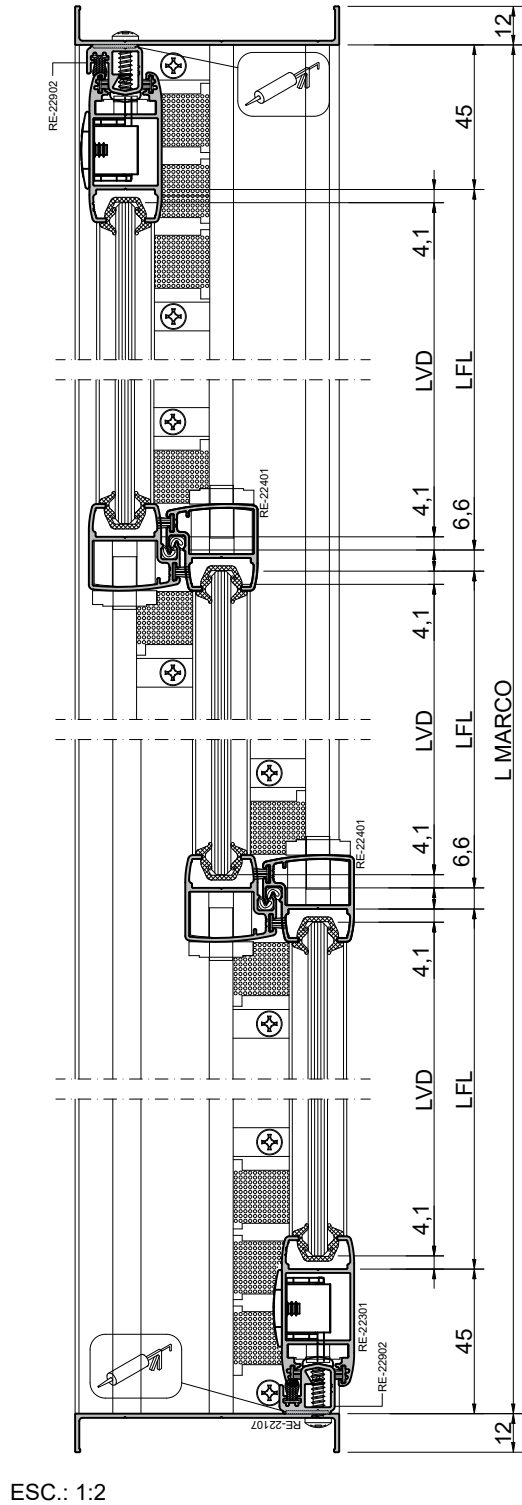









JANELA DE CORRER
3 FOLHAS PARA 3 PLANOS





COM PEITORIL FIXO



JANELA DE CORRER 3 FOLHAS PARA 3 PLANOS

COM PEITORIL FIXO

PERFIS					
CROQUI	CÓDIGO	CORTE	TAMANHO	QDE.	USINAGEM
	RE-22108	90 / 09	L-24	1	
	RE-22101	90 / 90	L-24	1	
	RE-22112	90 / 90	L-24	1	USI 12
	RE-22107	90 / 90	H	2	USI 6
	RE-22902	90 / 90	B-53	2	USI 8
	RE-22501	90 / 90	(L-127) / 3	6	
	RE-22301	90 / 90	B-53	2	USI 13
	22401	90 / 90	B-53	4	USI 14
	P-639	45 / 45	L-24	2	
	P-639	45 / 45	A-16	2	
	P-633	90 / 90	A-52	2	
	U-1230	90 / 90	(L-126)/3	6	
	U-1230	90 / 90	A-76	6	
	CL-006	90 / 90	21	4	
	CL-011	90 / 90	21	8	

GUARNIÇÕES/ESCOVAS			
CROQUI	CÓDIGO	MEDIDA	DESCRIÇÃO
	QL-5375	2*B	Qlon de vedação
	GXT-1128	(2*L)+(6*B)	Gaxeta p/ vidro 6 mm
	GNC-0001	4*B	Mão de amigo
	ECV-0010B	2*L	Escova 5X4 com barreira plastica
	EVC-0010B	6*H	Escova 5X4 com barreira plastica
	EVC-0001B	2*H	Escova 5X6 com barreira plastica
	GUA-259	(2*L)+(6*A)	Gaxeta de EPDM interna vidro 6mm

VIDRO JANELA

LARGURA	(L-152)/3
ALTURA	B-134

VIDRO PEITORIL

LARGURA	(L-144)/3
ALTURA	A-58

JANELA DE CORRER
3 FOLHAS PARA 3 PLANOS
COM PEITORIL FIXO

COMPONENTES				
CROQUI	REF.	QDE.	DESCRIÇÃO	OBS.
	PCP-4832PL	38	Fixação do marco/folha	
	PCP-3995	$((B/350)+1)*2$	Fixa mata junta	
	PCP-3995	$((2*(L+A))/350)+1$	Fixo peitoril	
	VDA-22001	8	Vedação superior e inferior	Ver tabela de componentes
	DRN-22001	3	Dreno	Ver tabela de componentes
	CTF-0001	2	Contra fecho	Ver tabela de componentes
	FCH-0002	2	Fecho concha JANELA	Ver tabela de componentes
	TRV-22001	2	Lingueta fecho concha	Ver tabela de componentes
	GDE-22001	4	Guia da folha lateral	Ver tabela de componentes
	GDE-22002	8	Guia da folha mão de amigo	Ver tabela de componentes
	RLD-22001	6	Roldana da folha	Ver tabela de componentes
	BTE-0008	6	Batedeira da folha	Ver tabela de componentes
	VDA-22005	12	Espuma polietileno fechamento interno	Ver tabela de componentes
	VDA-0011	2	Lã pet isolamento dos rasgos das conchas	Ver tabela de componentes
	P020010	24	Calço do vidro EPDM 6x3x50	Calço do vidro peitoril
	ESP-11x4	$(2*(L+A))$	Espuma Polietileno 11x4	Vedação quadro fixo
	GUA-258	$(2*(L+A))$	Espuma PVC 11x4	Esp. vidro 6 mm
	GUA-171	$4*A$	Espuma PVC 11x3	Esp. vidro 6 mm coluna

JANELA DE CORRER

3 FOLHAS PARA 3 PLANOS

COM BANDEIRA E PEITORIL FIXOS

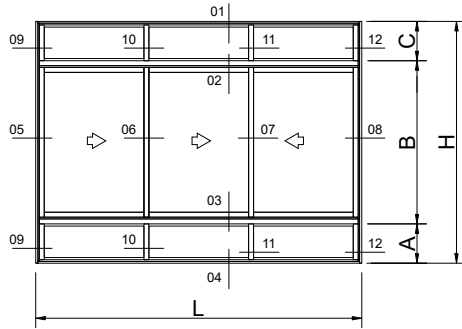

RE22-JCR303

VER COMBINAÇÕES DE PERFIS
NA SESSÃO: DETALHES

LADO EXTERNO

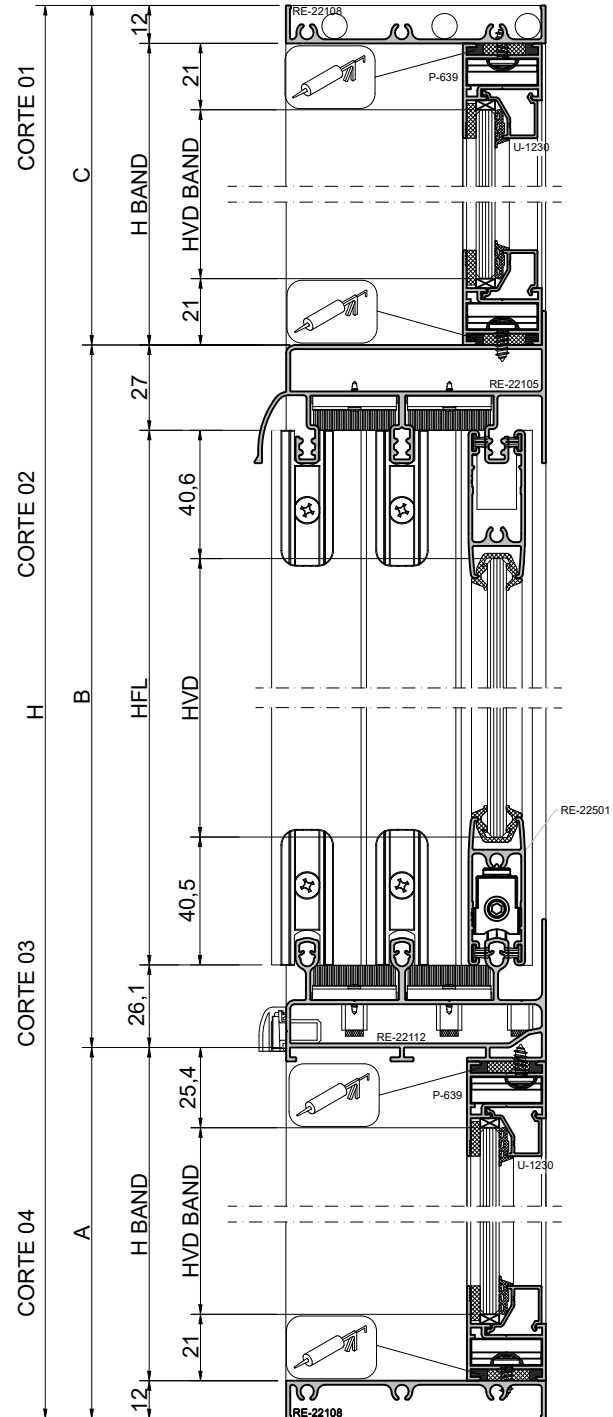

ESC.: 1:2

JANELA DE CORRER
3 FOLHAS PARA 3 PLANOS



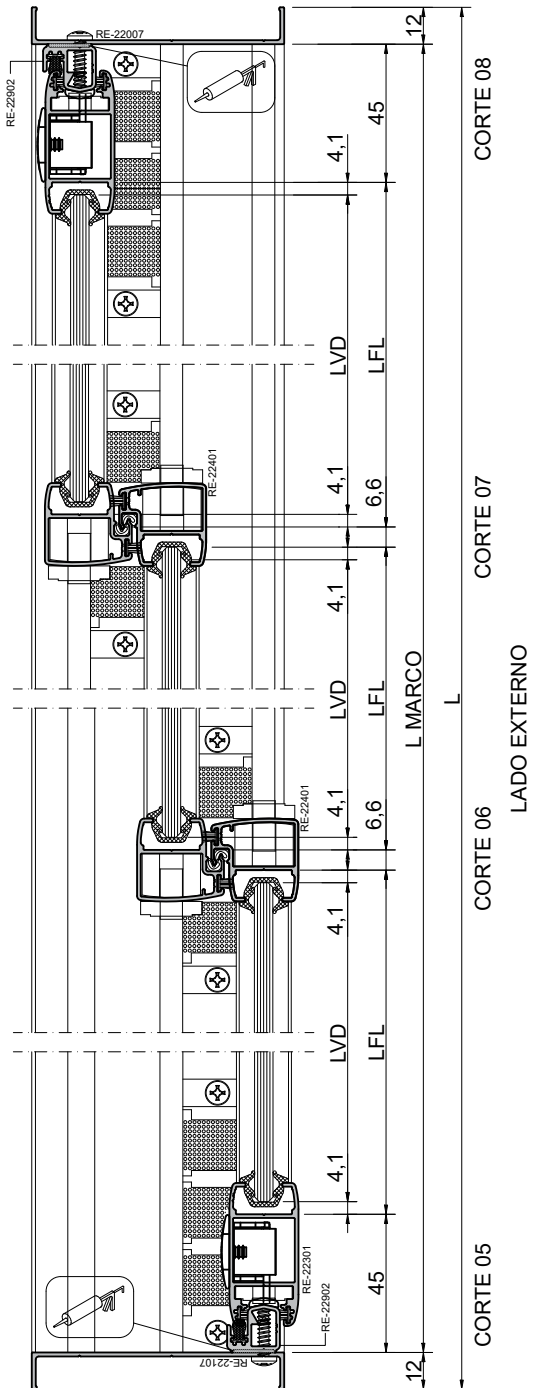
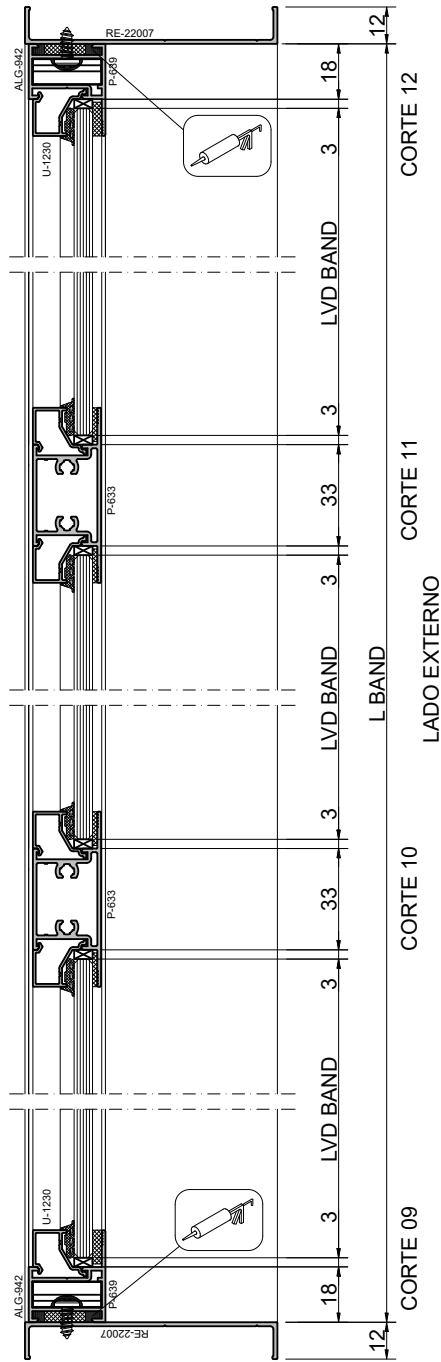

















COM BANDEIRA E PEITORIL FIXOS











ESC.: 1:2

JANELA DE CORRER 3 FOLHAS PARA 3 PLANOS

COM BANDEIRA E PEITORIL FIXOS

PERFIS					
CROQUI	CÓDIGO	CORTE	TAMANHO	QDE.	USINAGEM
	RE-22108	90 / 09	L-24	2	
	RE-22105	90 / 90	L-24	1	
	RE-22112	90 / 90	L-24	1	USI 12
	RE-22107	90 / 90	H	2	USI 6
	RE-22902	90 / 90	B-53	2	USI 8
	RE-22501	90 / 90	(L-127) / 3	6	
	RE-22301	90 / 90	B-53	2	USI 13
	22401	90 / 90	B-53	4	USI 14
	P-639	45 / 45	L-24	2	band.
	P-639	45 / 45	C-12	2	band.
	P-633	90 / 90	C-48	2	band.
	U-1230	90 / 90	(L-126)3	6	band.
	U-1230	90 / 90	C-72	6	band.
	P-639	45 / 45	L-24	2	peitoril
	P-639	45 / 45	A-16	2	peitoril
	P-633	90 / 90	A-52	2	peitoril
	U-1230	90 / 90	(L-126)/3	6	peitoril
	U-1230	90 / 90	A-76	6	peitoril
	CL-006	90 / 90	21	8	
	CL-011	90 / 90	21	16	

GUARNIÇÕES/ESCOVAS			
CROQUI	CÓDIGO	MEDIDA	DESCRIÇÃO
	QL-5375	2*B	Qlon de vedação
	GXT-1128	(2*L)+(6*B)	Gaxeta p/ vidro 6 mm
	GNC-0001	4*B	Mão de amigo
	ECV-0010B	2*L	Escova 5X4 com barreira plastica
	EVC-0010B	4*B	Escova 5X4 com barreira plastica
	EVC-0001B	4*B	Escova 5X6 com barreira plastica
	GUA-259	(2*L)+(6*C)	Gaxeta de EPDM interna vidro 6mm
	GUA-259	(2*L)+(6*A)	Gaxeta de EPDM interna vidro 6mm

VIDRO JANELA

LARGURA	(L-152)/3
---------	-----------

ALTURA	B-134
--------	-------

VIDRO PEITORIL

LARGURA	(L-144)/3
---------	-----------

ALTURA	A-58
--------	------

VIDRO BANDEIRA

LARGURA	(L-144)/3
---------	-----------

ALTURA	C-54
--------	------

JANELA DE CORRER
3 FOLHAS PARA 3 PLANOS
COM BANDEIRA E PEITORIL FIXOS

COMPONENTES				
CROQUI	REF.	QDE.	DESCRIÇÃO	OBS.
	PCP-4832PL	52	Fixação do marco/folha	
	PCP-3995	$((B/350)+1)*2$	Fixa mata junta	
	PCP-3995	$((2*(L+A))/350)+1$	Fixa peitoril	
	PCP-3995	$((2*(L+C))/350)+1$	Fixa bandeira	
	VDA-22001	8	Vedação superior e inferior	Ver tabela de componentes
	DRN-22001	3	Dreno	Ver tabela de componentes
	CTF-0001	2	Contra fecho	Ver tabela de componentes
	FCH-0002	2	Fecho concha JANELA	Ver tabela de componentes
	TRV-22001	2	Lingueta fecho concha	Ver tabela de componentes
	GDE-22001	4	Guia da folha lateral	Ver tabela de componentes
	GDE-22002	8	Guia da folha mão de amigo	Ver tabela de componentes
	RLD-22001	6	Roldana da folha	Ver tabela de componentes
	BTE-0008	6	Batedeira da folha	Ver tabela de componentes
	VDA-22005	12	Espuma polietileno fechamento interno	Ver tabela de componentes
	VDA-0011	2	Lã pet isolamento dos rasgos das conchas	Ver tabela de componentes
	P020010	48	Calço do vidro EPDM 6x3x50	Calço do vidro bandeira/peitoril
	ESP-11x4	$(2*(L+B))+2*(L+C)$	Espuma polietileno 11x4	Vedação quadro fixo
	GUA-258	$(2*(L+B))+2*(L+C)$	Espuma PVC 11X4	Esp. vidro 6 mm
	GUA-171	$(4*B)+(4*C)$	Espuma PVC 11x3	Esp. vidro 6 mm coluna

JANELA DE CORRER 3 FOLHAS

2 COM VENEZIANA E 1 EM VIDRO

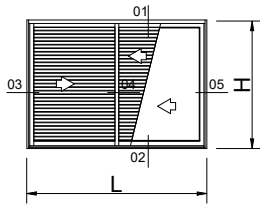

RE22-JCV300

VER COMBINAÇÕES DE PERFIS
NA SESSÃO: DETALHES

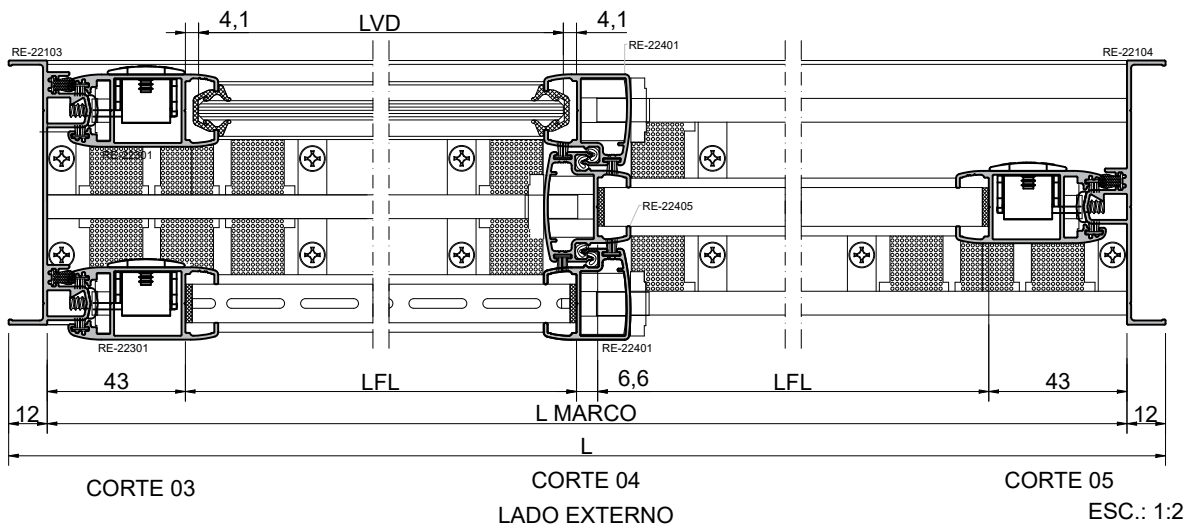
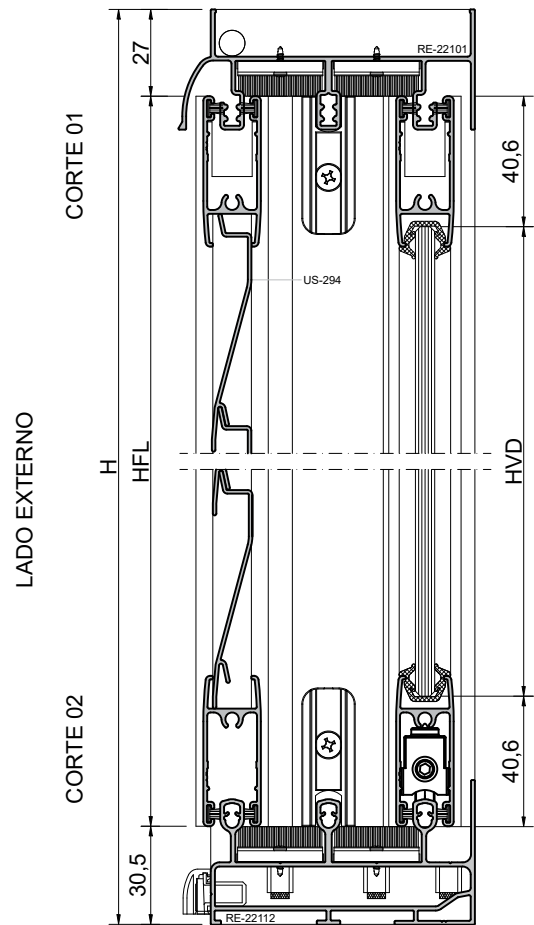

JANELA DE CORRER
3 FOLHAS

2 COM VENEZIANA E 1 EM VIDRO

PERFIS					
CROQUI	CÓDIGO	CORTE	TAMANHO	QDE.	USINAGEM
	RE-22101	90 / 90	L-24	1	
	RE-22112	90 / 90	L-24	1	USI 12
	RE-22103	90 / 90	H	1	USI 3
	RE-22104	90 / 90	H	1	USI 4
	RE-22501	90 / 90	(L-117)/2	6	
	RE-22301	90 / 90	H-57	3	USI 13
	RE-22401	90 / 90	H-57	2	USI 14
	RE-22405	90 / 90	H-57	1	USI 14
	Z-284	90 / 90	(L-124)/2	(H-131)/60	
	US-294	90 / 90	(L-124)/2	(H-131)/60	

GUARNIÇÕES/ESCOVAS			
CROQUI	CÓDIGO	MEDIDA	DESCRIÇÃO
	QL-5375	2*B	Qlon de vedação
	GXT-1128	(2*L)+(2*H)	Gaxeta p/ vidro 6 mm
	ESP-1118	(2*L)+(4*H)	Espuma 1 face adesiva 11x1.8
	GNC-0001	4*H	Mão de amigo
	ECV-0010B	5*L	Escova 5X4 com barreira plastica
	EVC-0010B	6*H	Escova 5X4 com barreira plastica
	EVC-0001B	4*H	Escova 5X6 com barreira plastica

VIDRO JANELA	
LARGURA	(L-133)/2
ALTURA	A-139

JANELA DE CORRER

3 FOLHAS

2 COM VENEZIANA E 1 EM VIDRO

COMPONENTES				
CROQUI	REF.	QDE.	DESCRIÇÃO	OBS.
	PCP-4832PL	24	Fixação do marco/folha	
	VDA-22001	10	Vedação superior e inferior	Ver tabela de componentes
	DRN-22001	2	Dreno	Ver tabela de componentes
	CTF-0001	2	Contra fecho	Ver tabela de componentes
	FCH-0002	2	Fecho concha JANELA	Ver tabela de componentes
	TRV-22001	2	Lingueta fecho concha	Ver tabela de componentes
	GDE-22001	6	Guia da folha lateral	Ver tabela de componentes
	GDE-22002	6	Guia da folha mão de amigo	Ver tabela de componentes
	RLD-22001	6	Roldana da folha	Ver tabela de componentes
	BTE-0008	6	Batedeira da folha	Ver tabela de componentes
	VDA-22005	12	Espuma polietileno fechamento interno	Ver tabela de componentes
	VDA-0011	2	Lã pet isolamento dos rasgos das conchas	Ver tabela de componentes

**PORTA DE CORRER
3 FOLHAS**

2 COM VENEZIANA E 1 EM VIDRO

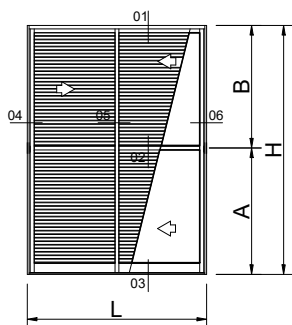

RE22-PCV300

VER COMBINAÇÕES DE PERFIS
NA SESSÃO: DETALHES

LADO EXTERNO

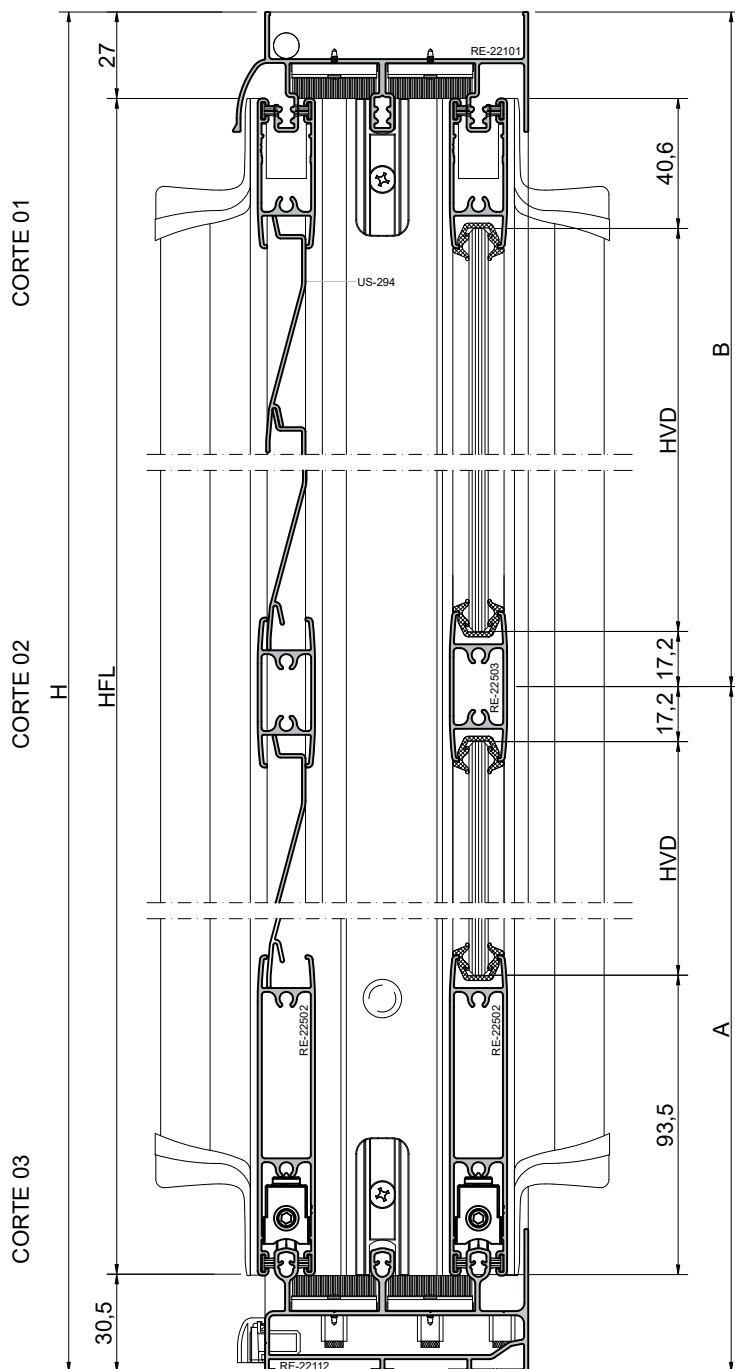

ESC.: 1:2

PORTA DE CORRER 3 FOLHAS

2 COM VENEZIANA E 1 EM VIDRO

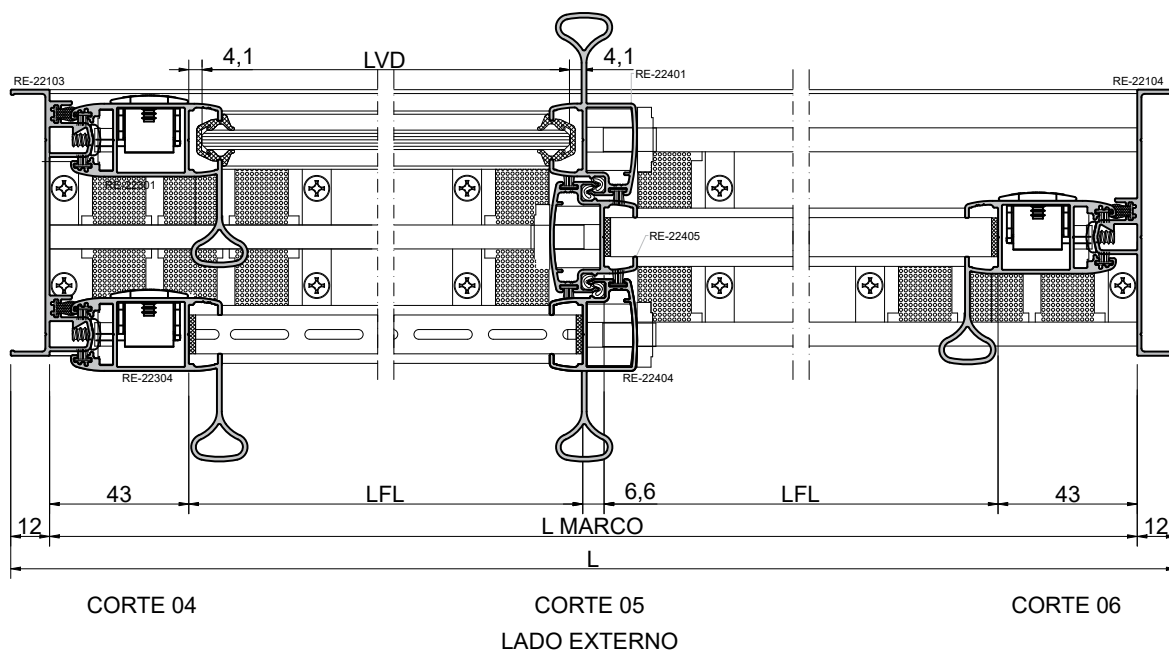









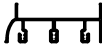
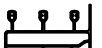
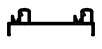
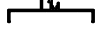

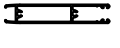
GUARNIÇÕES/ESCOVAS			
CROQUI	CÓDIGO	MEDIDA	DESCRIÇÃO
	QL-5375	2*B	Qlon de vedação
	GXT-1128	(2*L)+(2*H)	Gaxeta p/ vidro 6 mm
	ESP-1118	(2*L)+(4*H)	Espuma 1 face adesiva 11x1.8
	GNC-0001	4*H	Mão de amigo
	ECV-0010B	5*L	Escova 5X4 com barreira plastica
	EVC-0010B	6*H	Escova 5X4 com barreira plastica
	EVC-0001B	4*H	Escova 5X6 com barreira plastica

VIDRO PORTA	
LARGURA	(L-133)/2
ALTURA	A-141
ALTURA	B-85

ESC.: 1:2

PORTA DE CORRER
3 FOLHAS
2 COM VENEZIANA E 1 EM VIDRO

PERFIS					
CROQUI	CÓDIGO	CORTE	TAMANHO	QDE.	USINAGEM
	RE-22101	90 / 90	L-24	1	
	RE-22112	90 / 90	L-24	1	USI 12
	RE-22103	90 / 90	H	1	USI 3
	RE-22104	90 / 90	H	1	USI 4
	RE-22501	90 / 90	(L-117)/2	3	
	RE-22503	90 / 90	(L-117)/2	3	
	RE-22503	90 / 90	(L-117)/2	3	
	RE-22304	90 / 90	H-57	3	USI 13
	RE-22404	90 / 90	H-57	2	USI 14
	RE-22405	90 / 90	H-57	1	USI 14
	Z-284	90 / 90	(L-125)/2	(A-135)/60	
	Z-284	90 / 90	(L-125)/2	(B-75)/60	
	US-294	90 / 90	(L-125)/2	(A-135)/60	
	US-294	90 / 90	(L-125)/2	(B-75)/60	

PORTA DE CORRER 3 FOLHAS

2 COM VENEZIANA E 1 EM VIDRO

COMPONENTES				
CROQUI	REF.	QDE.	DESCRIÇÃO	OBS.
	PCP-4832PL	36	Fixação do marco/folha	
	VDA-22001	10	Vedação superior e inferior	Ver tabela de componentes
	DRN-22001	2	Dreno	Ver tabela de componentes
	CTF-0001	3	Contra fecho	Ver tabela de componentes
	FCH-0004	3	Fecho concha PORTA	Ver tabela de componentes
	TRV-22001	3	Lingueta fecho concha	Ver tabela de componentes
	GDE-22001	6	Guia da folha lateral	Ver tabela de componentes
	GDE-22002	6	Guia da folha mão de amigo	Ver tabela de componentes
	RLD-22002	6	Roldana da folha	Ver tabela de componentes
	TMT-0002	8	Tampa montante	Ver tabela de componentes
	TMT-0004	18	Tampa furo	Ver tabela de componentes
	BTE-0001	6	Batedeira da folha	Ver tabela de componentes
	VDA-22005	12	Espuma polietileno fechamento interno	Ver tabela de componentes
	VDA-0011	2	Lã pet isolamento dos rasgos das conchas	Ver tabela de componentes

PORTA DE CORRER
3 FOLHAS PARA 3 PLANOS

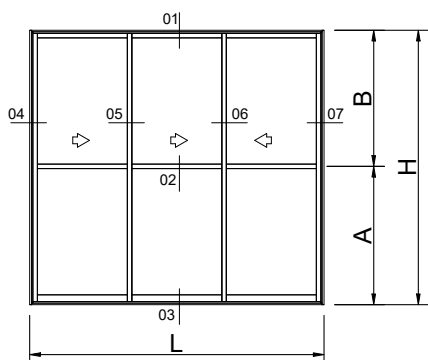

RE22-PCR300

VER COMBINAÇÕES DE PERFIS
NA SESSÃO: DETALHES

LADO EXTERNO

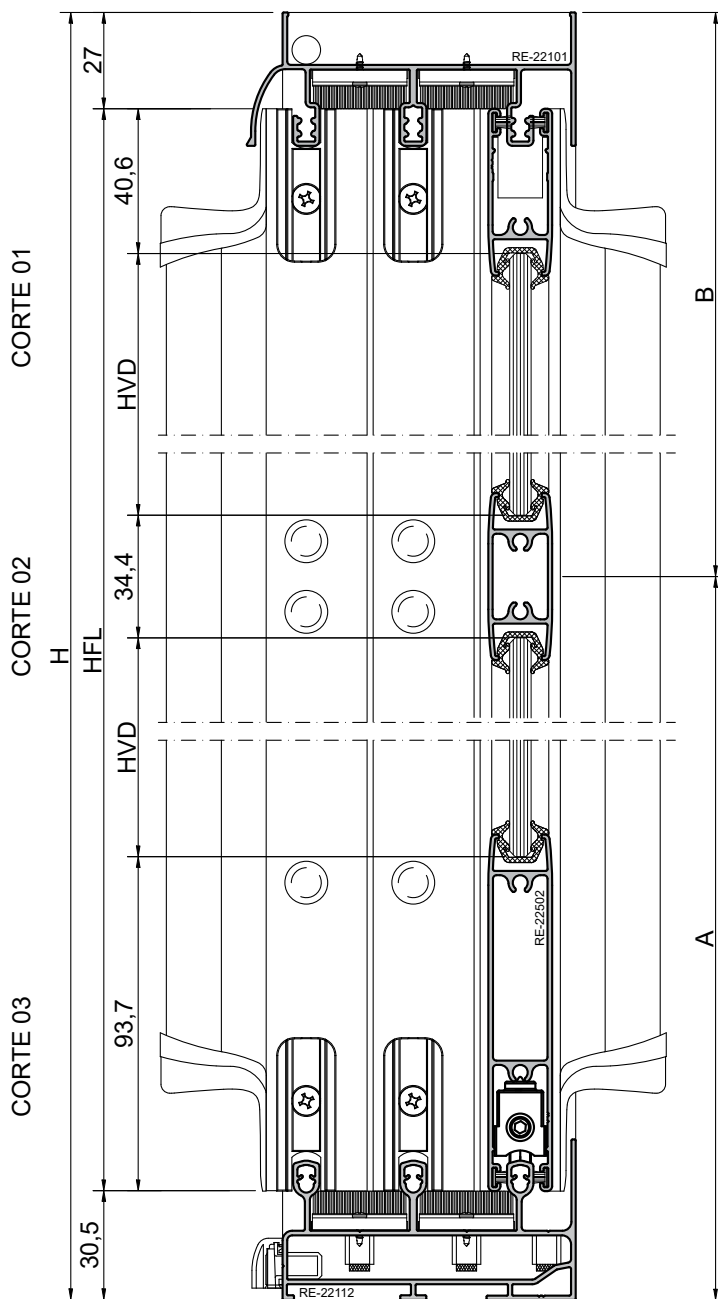

ESC.: 1:2





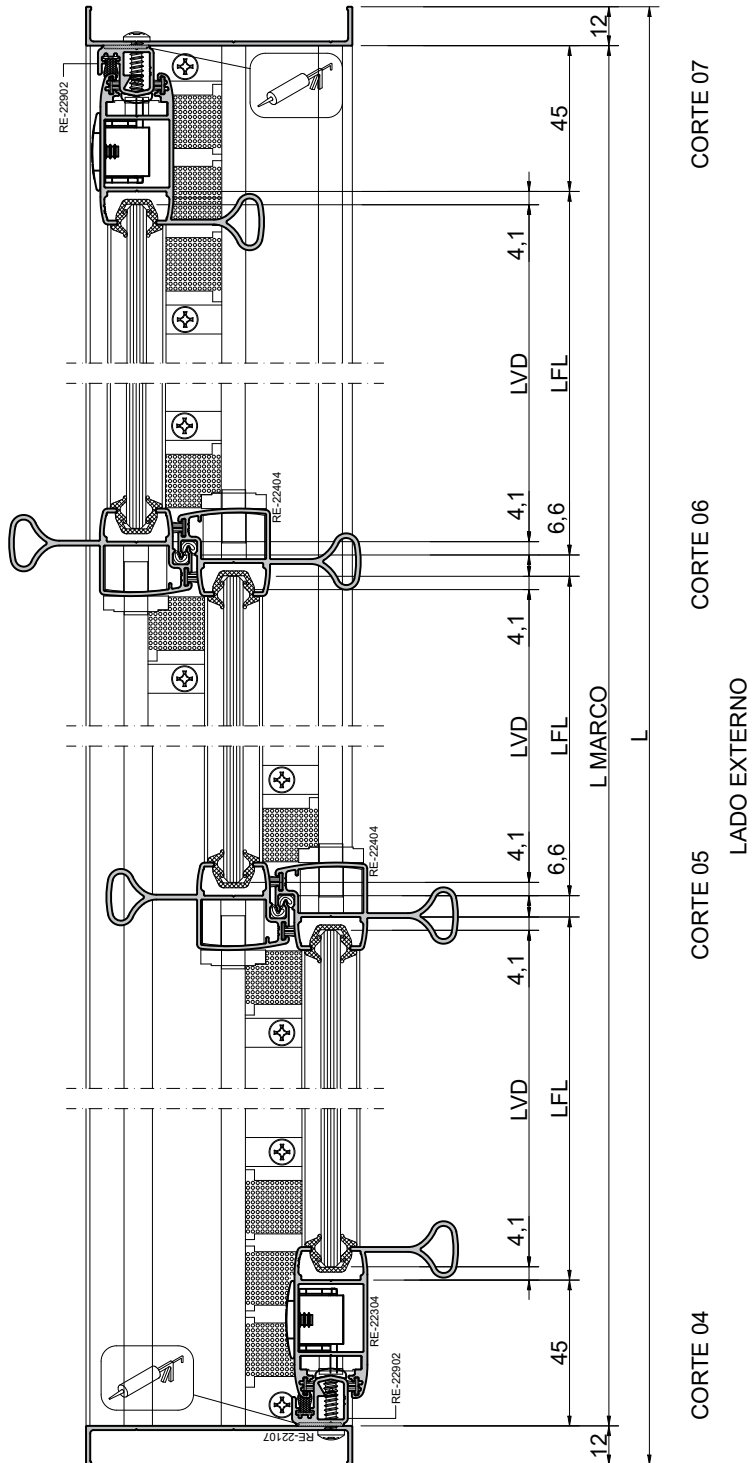



PORTA DE CORRER

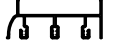

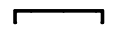

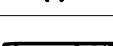

3 FOLHAS PARA 3 PLANOS



ESC.: 1:2

PORTA DE CORRER
3 FOLHAS PARA 3 PLANOS

PERFIS					
CROQUI	CÓDIGO	CORTE	TAMANHO	QDE.	USINAGEM
	RE-22101	90 / 90	L-24	1	
	RE-22112	90 / 90	L-24	1	USI 12
	RE-22107	90 / 90	H	2	USI 7
	RE-22902	90 / 90	H-57	2	USI 8
	RE-22501	90 / 90	(L-127) / 3	3	
	RE-22503	3	(L-127) / 3	3	USI 15
	RE-22502	3	(L-127) / 3	3	
	RE-22304	90 / 90	H-57	2	USI 13
	RE-22404	90 / 90	H-57	4	USI 14

GUARNIÇÕES/ESCOVAS			
CROQUI	CÓDIGO	MEDIDA	DESCRIÇÃO
	QL-5375	2*H	Qlon de vedação
	GXT-1128	(4*L)+(6*H)	Gaxeta p/ vidro 6 mm
	GNC-0001	4*H	Mão de amigo
	ECV-0010B	4*L	Escova 5X4 com barreira plastica
	EVC-0010B	4*H	Escova 5X4 com barreira plastica
	EVC-0001B	4*H	Escova 5X6 com barreira plastica

VIDRO PORTA	
LARGURA	(L-152)/3
ALTURA	A-141
ALTURA	B-85

PORTA DE CORRER 3 FOLHAS PARA 3 PLANOS

COMPONENTES				
CROQUI	REF.	QDE.	DESCRIÇÃO	OBS.
	PCP-4832PL	42	Fixação do marco/folha	
	PCP-3995	$((H/350)+1)*2$	Fixa mata junta	
	VDA-22001	8	Vedação superior e inferior	Ver tabela de componentes
	DRN-22001	3	Dreno	Ver tabela de componentes
	CTF-0001	2	Contra fecho	Ver tabela de componentes
	FCH-0004	2	Fecho concha PORTA	Ver tabela de componentes
	TRV-22001	2	Lingueta fecho concha	Ver tabela de componentes
	GDE-22001	4	Guia da folha lateral	Ver tabela de componentes
	GDE-22002	8	Guia da folha mão de amigo	Ver tabela de componentes
	RLD-22002	6	Roldana da folha	Ver tabela de componentes
	TMT-0002	12	Tampa montante	Ver tabela de componentes
	TMT-0004	18	Tampa furo	Ver tabela de componentes
	BTE-0001	6	Batedeira da folha	Ver tabela de componentes
	VDA-22005	12	Espuma polietileno fechamento interno	Ver tabela de componentes
	VDA-0011	2	Lã pet isolamento dos rasgos das conchas	Ver tabela de componentes

PORTA DE CORRER
3 FOLHAS PARA 3 PLANOS

COM BANDEIRA FIXA

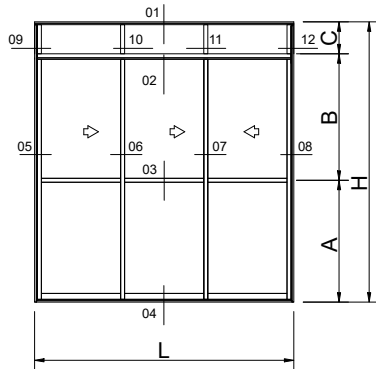

VER COMBINAÇÕES DE PERFIS
NA SESSÃO: DETALHES

LADO EXTERNO

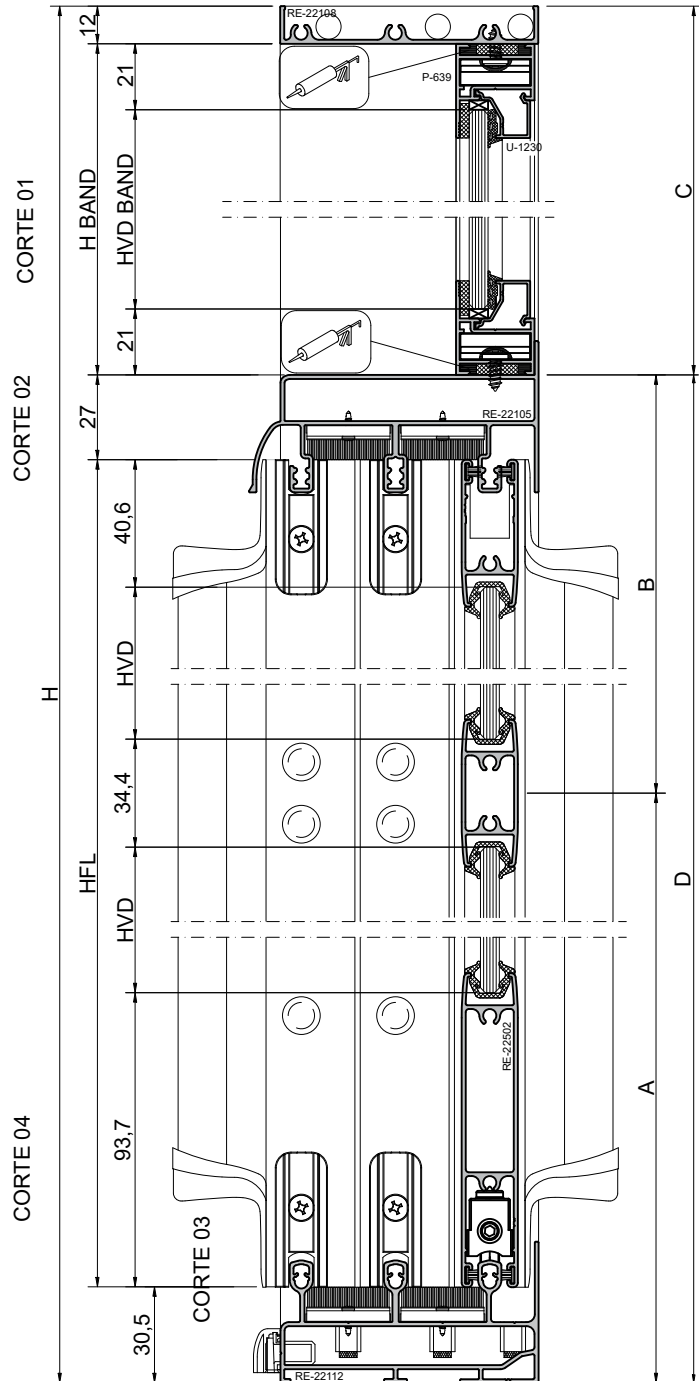

ESC.: 1:2

PORTA DE CORRER 3 FOLHAS PARA 3 PLANOS



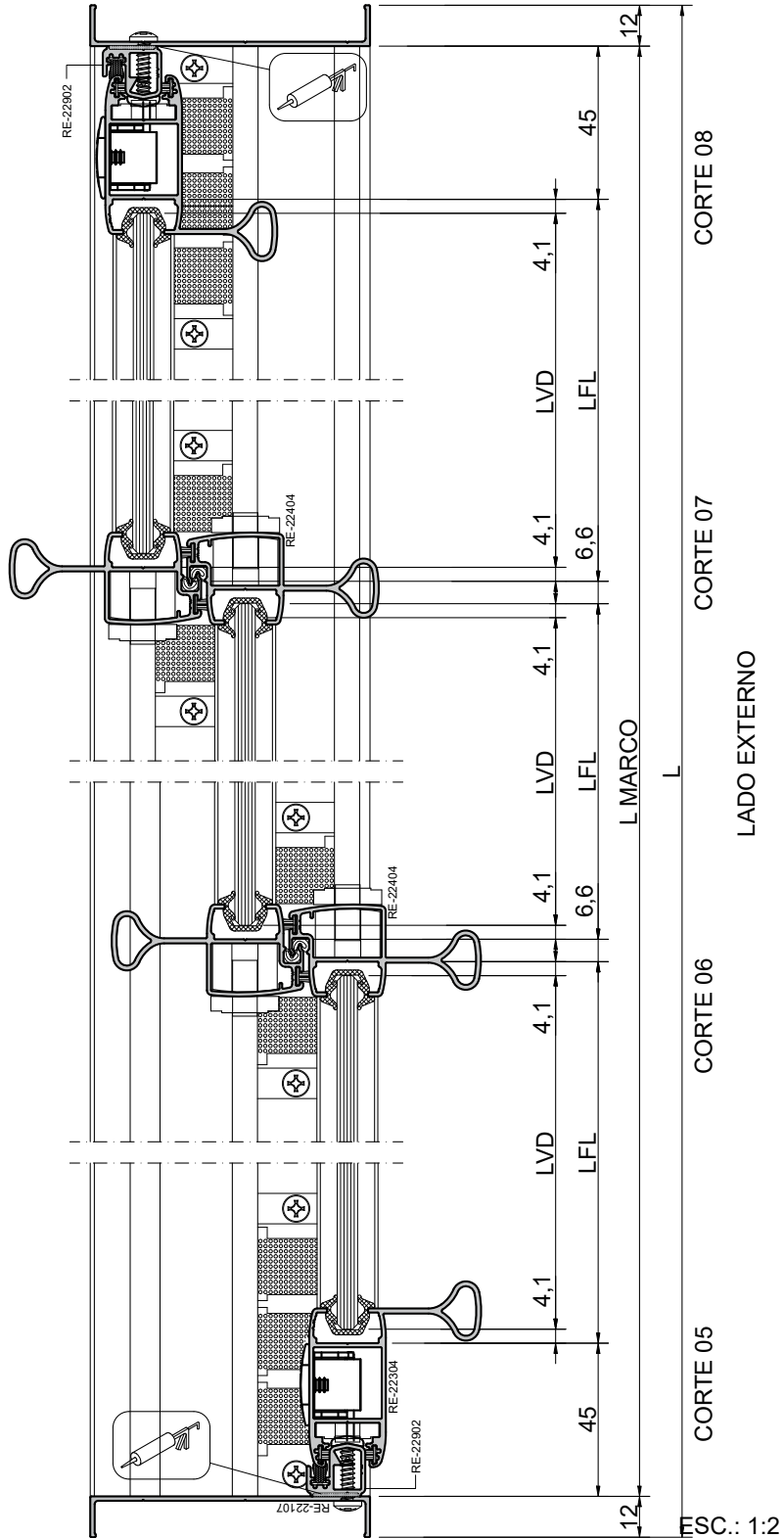
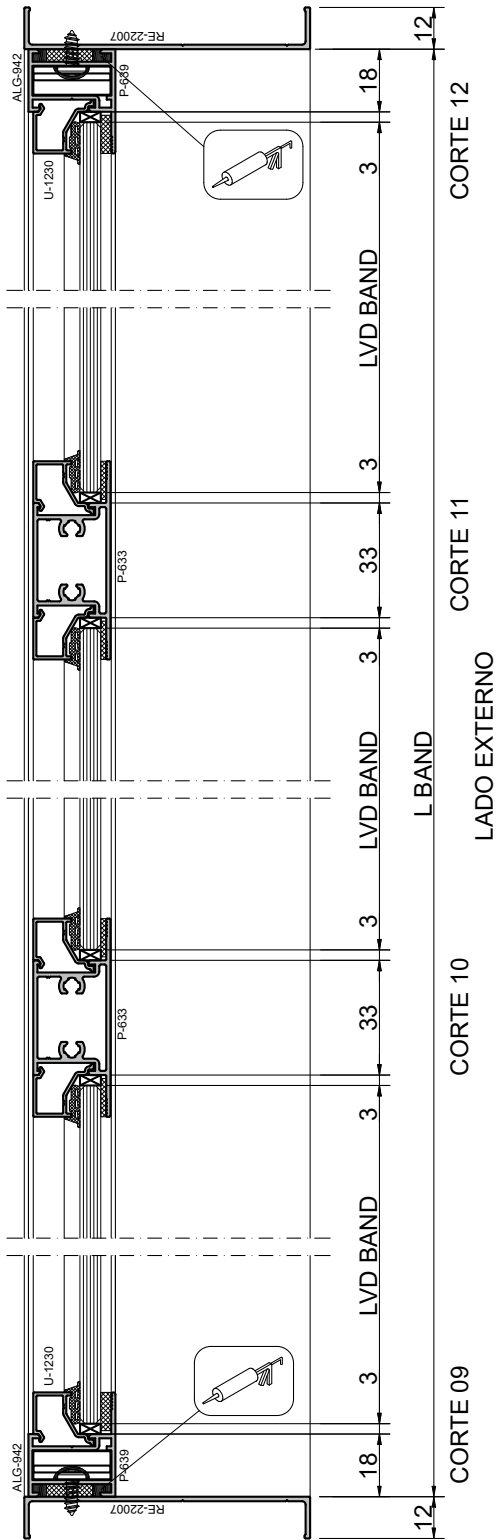













COM BANDEIRA FIXA









ESCALA: 1:2

PORTA DE CORRER 3 FOLHAS PARA 3 PLANOS

COM BANDEIRA FIXA

PERFIS					
CROQUI	CÓDIGO	CORTE	TAMANHO	QDE.	USINAGEM
	RE-22108	90 / 09	L-24	1	
	RE-22105	90 / 90	L-24	1	
	RE-22112	90 / 90	L-24	1	USI 12
	RE-22107	90 / 90	H	2	USI 6
	RE-22902	90 / 90	(A+B)-57	2	USI 8
	RE-22501	90 / 90	(L-127) / 3	3	
	RE-22503	90 / 90	(L-127) / 3	3	
	RE-22502	90 / 90	(L-127) / 3	3	
	RE-22304	90 / 90	(A+B)-57	2	USI 13
	RE-22404	90 / 90	(A+B)-57	4	USI 14
	P-639	45 / 45	L-24	2	
	P-639	45 / 45	C-12	2	
	P-633	90 / 90	C-48	2	
	U-1230	90 / 90	(L-126)/3	6	
	U-1230	90 / 90	C-72	6	
	CL-006	90 / 90	21	4	
	CL-011	90 / 90	21	8	

GUARNIÇÕES/ESCOVAS			
CROQUI	CÓDIGO	MEDIDA	DESCRIÇÃO
	QL-5375	2*AB	Qlon de vedação
	GXT-1128	(2*L)+(6*AB)	Gaxeta p/ vidro 6 mm
	GNC-0001	4*(H+AB)	Mão de amigo
	ECV-0010B	4*L	Escova 5X4 com barreira plastica
	EVC-0010B	4*H	Escova 5X4 com barreira plastica
	EVC-0001B	4*H	Escova 5X6 com barreira plastica
	GUA-259	(2*L)+(4*C)	Gaxeta de EPDM interna vidro 6mm

VIDRO PORTA

LARGURA	(L-152)/3
ALTURA	A-141
ALTURA	B-85

VIDRO BANDEIRA

LARGURA	(L-144)/3
ALTURA	C-54

PORTA DE CORRER 3 FOLHAS PARA 3 PLANOS

COM BANDEIRA FIXA

COMPONENTES				
CROQUI	REF.	QDE.	DESCRIÇÃO	OBS.
	PCP-4832PL	42	Fixação do marco/folha	
	PCP-3995	$((D/350)+1) \times 2$	Fixa mata junta	
	PCP-3995	$((2*(L+C))/350)+1$	Fixa bandeira	
	VDA-22001	8	Vedação superior e inferior	Ver tabela de componentes
	DRN-22001	3	Dreno	Ver tabela de componentes
	CTF-0001	2	Contra fecho	Ver tabela de componentes
	FCH-0004	2	Fecho concha PORTA	Ver tabela de componentes
	TRV-22001	2	Lingueta fecho concha	Ver tabela de componentes
	GDE-22001	4	Guia da folha lateral	Ver tabela de componentes
	GDE-22002	8	Guia da folha mão de amigo	Ver tabela de componentes
	RLD-22002	6	Roldana da folha	Ver tabela de componentes
	TMT-0002	12	Tampa montante	Ver tabela de componentes
	TMT-0004	18	Tampa furo	Ver tabela de componentes
	BTE-0001	6	Batedeira da folha	Ver tabela de componentes
	VDA-22005	12	Espuma polietileno fechamento interno	Ver tabela de componentes
	VDA-0011	2	Lã pet isolamento dos rasgos das conchas	Ver tabela de componentes
	P020010	24	Calço do vidro EPDM 6x3x50	Calço do vidro bandeira
	ESP-11x4	$(2*(L+B))$	Espuma polietileno 11x4	Vedação quadro fixo
	GUA-258	$(2*(L+B))$	Espuma PVC 11X4	Esp. vidro 6 mm
	GUA-171	4*B	Espuma PVC 11x3	Esp. vidro 6 mm coluna

JANELA DE CORRER
2 FOLHAS PARA 2 PLANOS

FIXAÇÃO DIRETO NO CONCRETO SEM CONTRAMARCO

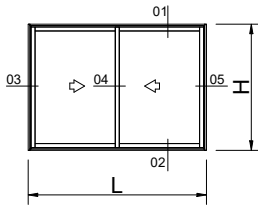

RE22-JCR200

VER COMBINAÇÕES DE PERFIS
NA SESSÃO: DETALHES

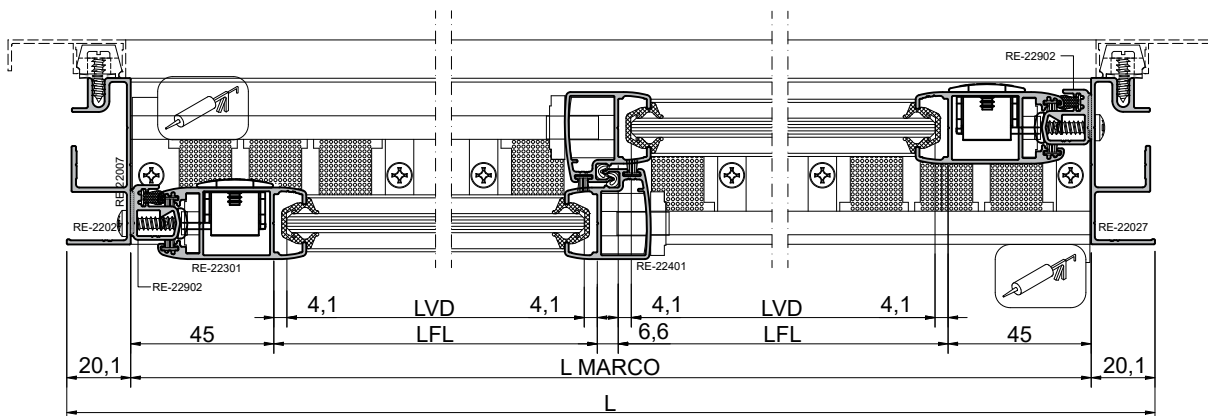
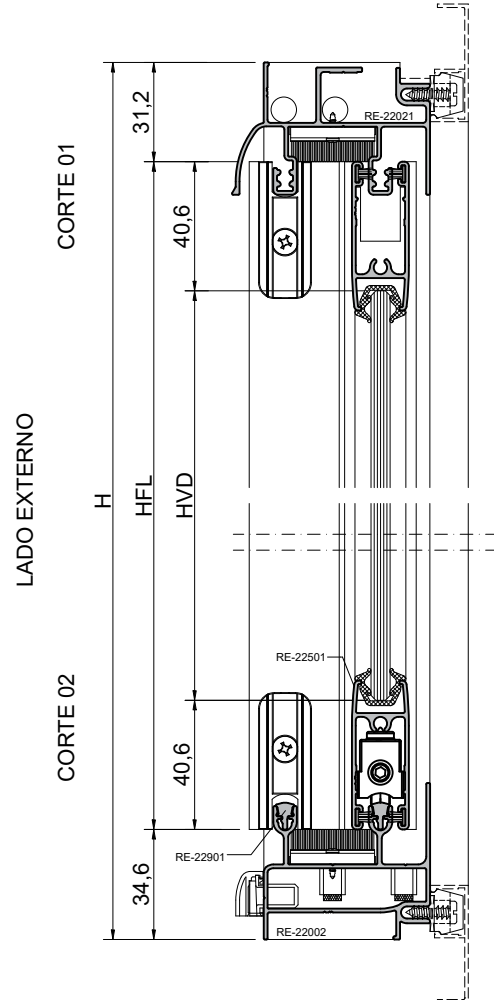

CORTE 03









CORTE 04
LADO EXTERNO







CORTE 05

ESC.: 1:2

JANELA DE CORRER 2 FOLHAS PARA 2 PLANOS

**FIXAÇÃO DIRETO NO CONCRETO
SEM CONTRAMARCO**

PERFIS					
CROQUI	CÓDIGO	CORTE	TAMANHO	QDE.	USINAGEM
	RE-22021	90 / 90	L-40	1	
	RE-22022	90 / 90	L-40	1	
	RE-22901	90 / 90	L-55	2	USI 19
	RE-22027	90 / 90	H	2	USI 34
	RE-22902	90 / 90	H-66	2	USI 8
	RE-22501	90 / 90	(L-137)/2	4	
	RE-22301	90 / 90	H-66	2	USI 13
	RE-22401	90 / 90	H-66	2	USI 14

GUARNIÇÕES/ESCOVAS			
CROQUI	CÓDIGO	MEDIDA	DESCRIÇÃO
	QL-5375	2*H	Qlon de vedação
	GXT-1128	(2*L)+(4*H)	Gaxeta p/ vidro 6 mm
	GNC-0001	2*H	Mão de amigo
	ECV-0010B	2*L	Escova 5X4 com barreira plastica
	EVC-0010B	4*H	Escova 5X4 com barreira plastica
	EVC-0001B	2*H	Escova 5X6 com barreira plastica

VIDRO JANELA	
LARGURA	(L-153)/2
ALTURA	H-147

JANELA DE CORRER

2 FOLHAS PARA 2 PLANOS

FIXAÇÃO DIRETO NO CONCRETO SEM CONTRAMARCO

COMPONENTES				
CROQUI	REF.	QDE.	DESCRIÇÃO	OBS.
	PCP-4832PL	16	Fixação do marco/folha	
	PCP-3995	$((H/350)+1)*2$	Fixa mata junta	
	VDA-22001	6	Vedação superior e inferior	Ver tabela de componentes
	DRN-22001	2	Dreno	Ver tabela de componentes
	CTF-0001	2	Contra fecho	Ver tabela de componentes
	FCH-0002	2	Fecho concha JANELA	Ver tabela de componentes
	TRV-22001	2	Lingueta fecho concha	Ver tabela de componentes
	GDE-22001	4	Guia da folha lateral	Ver tabela de componentes
	GDE-22002	4	Guia da folha mão de amigo	Ver tabela de componentes
	RLD-22001	4	Roldana da folha	Ver tabela de componentes
	BTE-0008	4	Batedeira da folha	Ver tabela de componentes
	VDA-22005	8	Espuma polietileno fechamento interno	Ver tabela de componentes
	VDA-0011	2	Lã pet isolamento dos rasgos das conchas	Ver tabela de componentes

PORTA DE CORRER 2 FOLHAS PARA 2 PLANOS

**FIXAÇÃO DIRETO NO CONCRETO
SEM CONTRAMARCO**

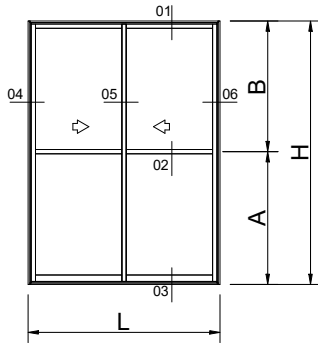

RE22-PCR200

VER COMBINAÇÕES DE PERFIS
NA SESSÃO: DETALHES

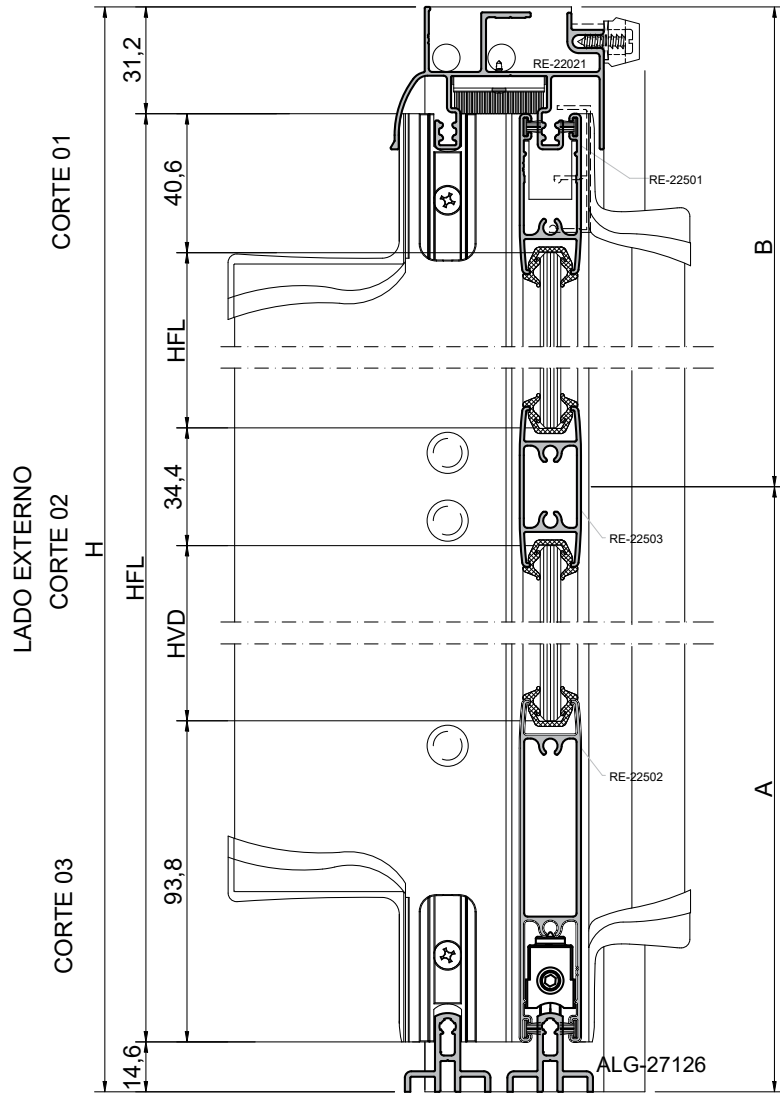

ESC.: 1:2

PORTA DE CORRER
2 FOLHAS PARA 2 PLANOS

FIXAÇÃO DIRETO NO CONCRETO
SEM CONTRAMARCO

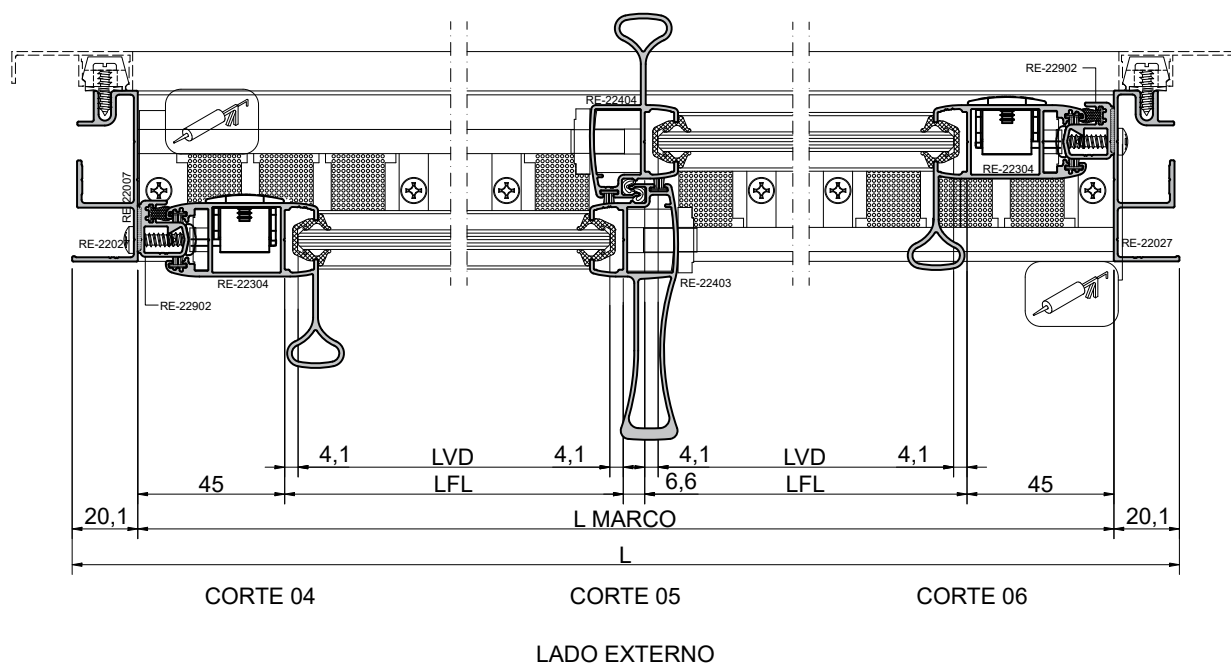

CORTE 04

CORTE 05

CORTE 06

LADO EXTERNO











GUARNIÇÕES/ESCOVAS			
CROQUI	CÓDIGO	MEDIDA	DESCRIÇÃO
	QL-5375	2*H	Qlon de vedação
	GXT-1128	(2*L)+(4*H)	Gaxeta p/ vidro 6 mm
	GNC-0001	2*H	Mão de amigo
	ECV-0010B	2*L	Escova 5X4 com barreira plastica
	EVC-0010B	4*H	Escova 5X4 com barreira plastica
	EVC-0001B	2*H	Escova 5X6 com barreira plastica

VIDRO JANELA	
LARGURA	(L-153)/2
ALTURA	A-126
ALTURA	B-89

ESC.: 1:2

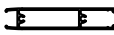
PORTA DE CORRER 2 FOLHAS PARA 2 PLANOS

**FIXAÇÃO DIRETO NO CONCRETO
SEM CONTRAMARCO**

PERFIS					
CROQUI	CÓDIGO	CORTE	TAMANHO	QDE.	USINAGEM
	RE-22021	90 / 90	L-40	1	
	ALG-27126	90 / 90	L-40	2	
	RE-22027	90 / 90	H	2	USI 35
	RE-22902	90 / 90	H-46	2	USI 8
	RE-22501	90 / 90	(L-137)/2	2	
	RE-22503	90 / 90	(L-137)/2	2	
	RE-22502	90 / 90	(L-137)/2	2	
	RE-22304	90 / 90	H-46	2	USI 13
	RE-22404	90 / 90	H-46	1	USI 14
	RE-22403	90 / 90	H-46	1	USI 14

PORTA DE CORRER
2 FOLHAS PARA 2 PLANOS
FIXAÇÃO DIRETO NO CONCRETO
SEM CONTRAMARCO

COMPONENTES				
CROQUI	REF.	QDE.	DESCRIÇÃO	OBS.
	PCP-4832PL	16	Fixação do marco/folha	
	PCP-3995	$((H/350)+1)*2$	Fixa mata junta	
	VDA-22001	6	Vedação superior e inferior	Ver tabela de componentes
	DRN-22001	2	Dreno	Ver tabela de componentes
	CTF-0001	2	Contra fecho	Ver tabela de componentes
	FCH-0004	2	Fecho concha PORTA	Ver tabela de componentes
	TRV-22001	2	Lingueta fecho concha	Ver tabela de componentes
	GDE-22001	4	Guia da folha lateral	Ver tabela de componentes
	GDE-22002	4	Guia da folha mão de amigo	Ver tabela de componentes
	RLD-22001	4	Roldana da folha	Ver tabela de componentes
	TMT-0002	6	Tampa montante	Ver tabela de componentes
	TMT-0021	2	Tampa montante	Ver tabela de componentes
	TMT-0004	12	Tampa furo	Ver tabela de componentes
	BTE-0001	4	Batedeira da folha	Ver tabela de componentes
	VDA-22005	8	Espuma polietileno fechamento interno	Ver tabela de componentes
	VDA-0011	2	Lã pet isolamento dos rasgos das conchas	Ver tabela de componentes

6

Detalhes Construtivos

MONTAGENS

**MONTAGENS COM MONTANTES CENTRAL
COM OPÇÃO DE PERFIL COM REFORÇO**

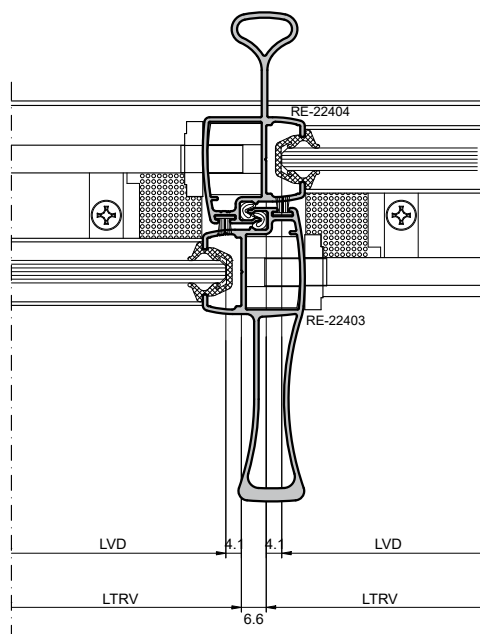
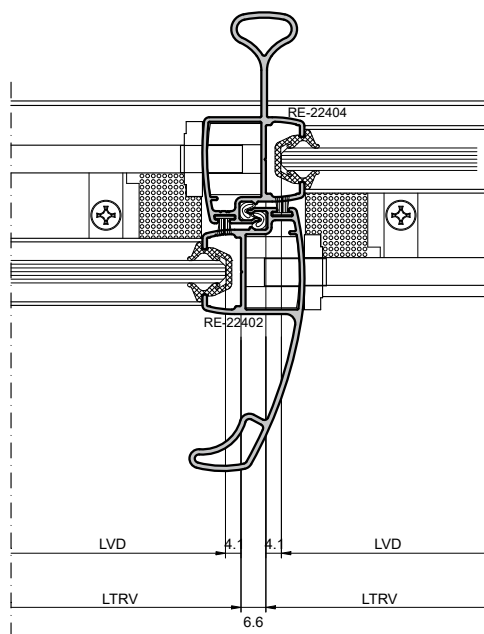
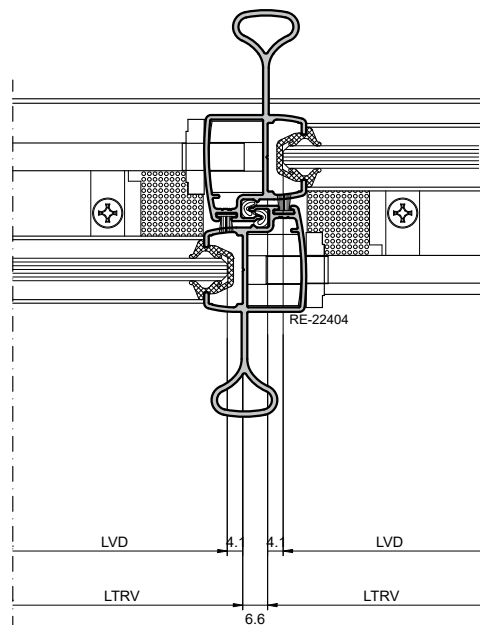
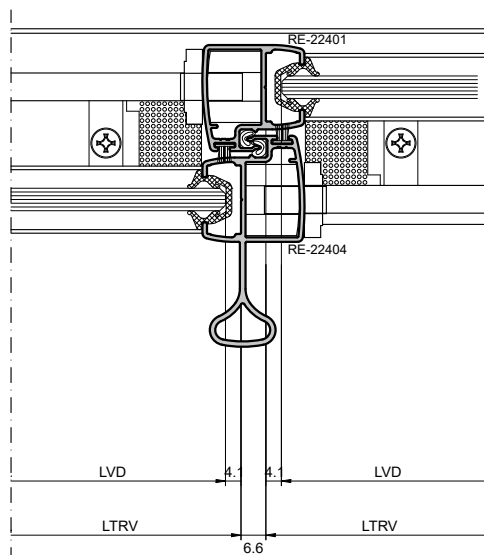

ESC.: 1:2

VEDAÇÃO COM ESCOVA COM BARREIRA PLÁSTICA;

MONTAGENS COM MONTANTES CENTRAL COM OPÇÃO DE PERFIL COM REFORÇO

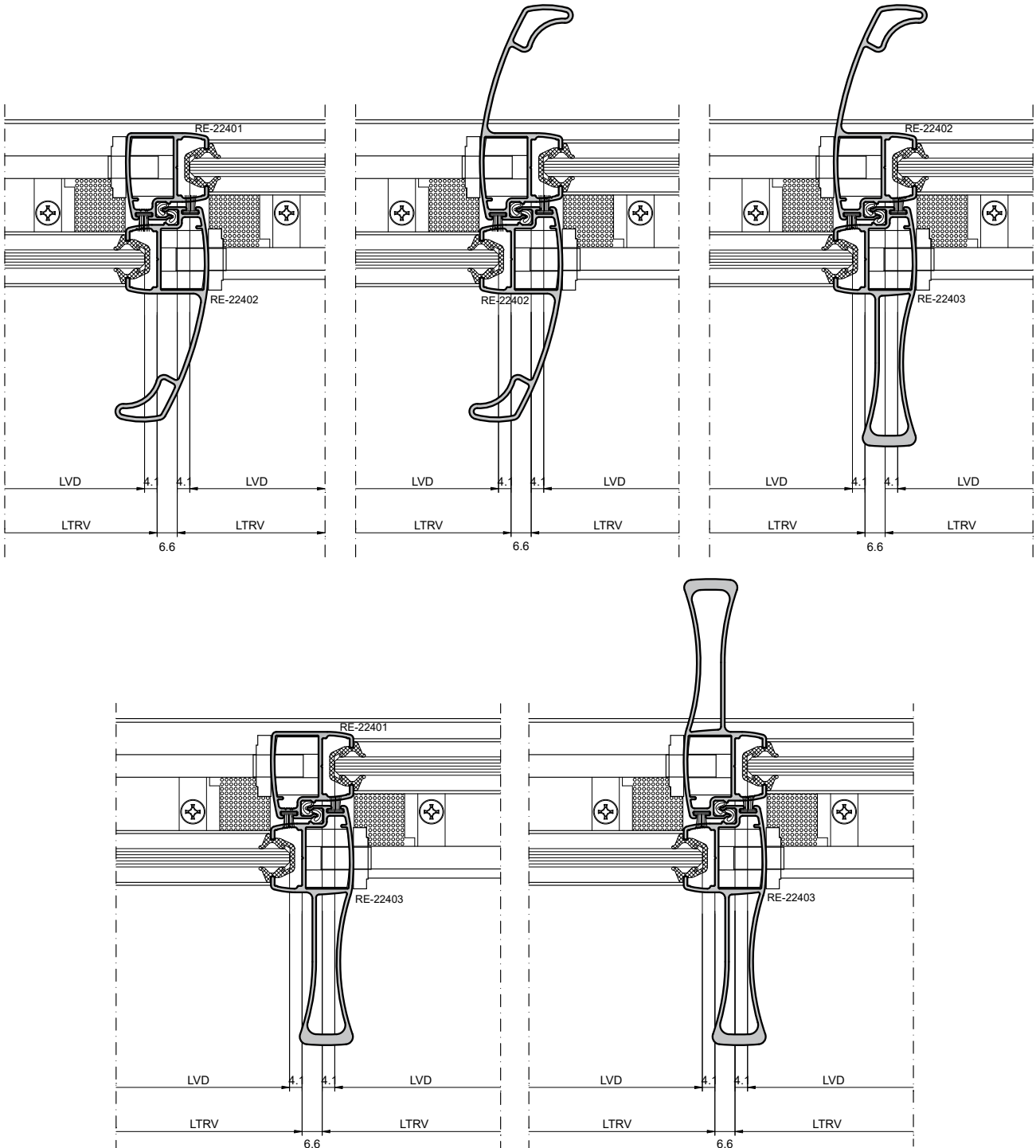

ESC.: 1:2

VEDAÇÃO COM ESCOVA COM BARREIRA PLÁSTICA;

**MONTAGENS COM MONTANTES CENTRAL
COM OPÇÃO DE PERFIL COM REFORÇO**

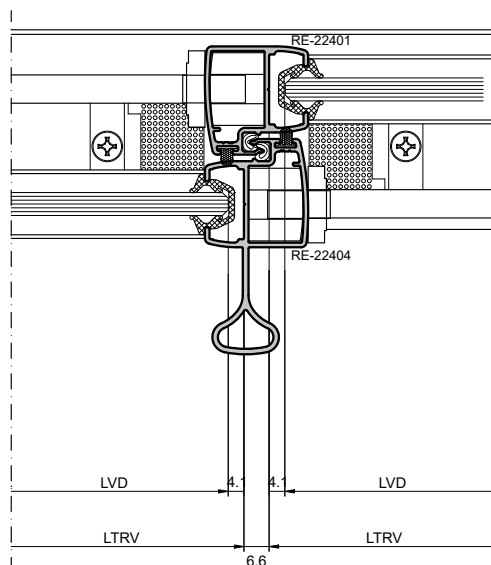

CORTE 04

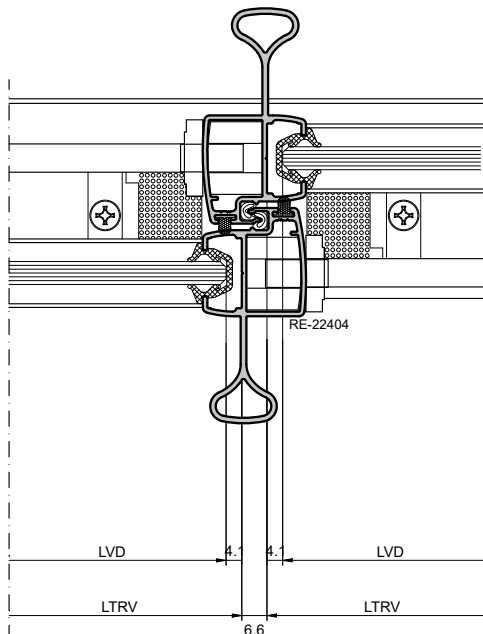

CORTE 04

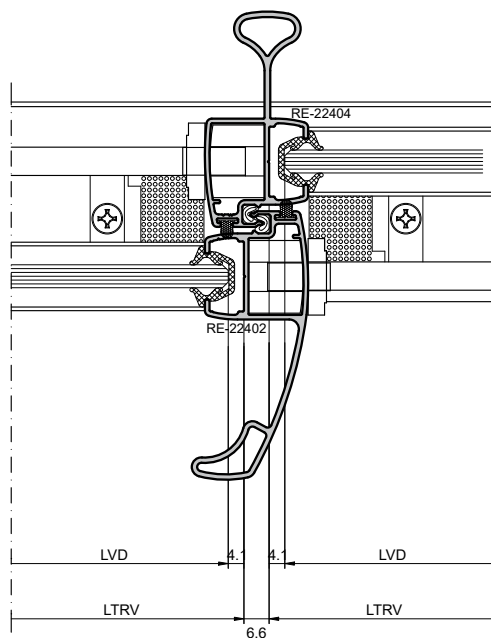

CORTE 04

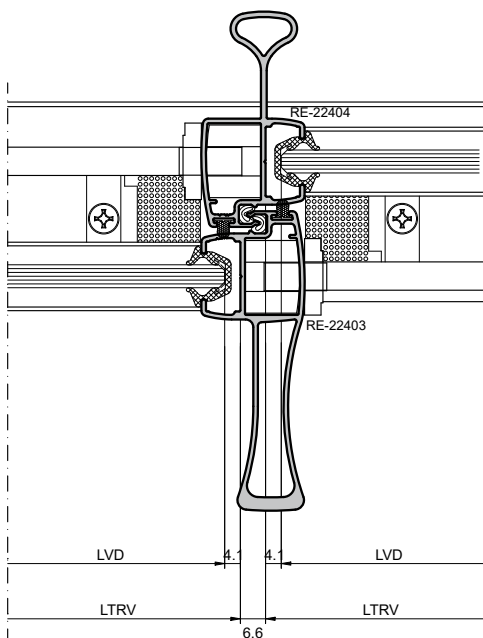

CORTE 04

ESC.: 1:2

VEDAÇÃO COM QLON;

MONTAGENS COM MONTANTES CENTRAL COM OPÇÃO DE PERFIL COM REFORÇO

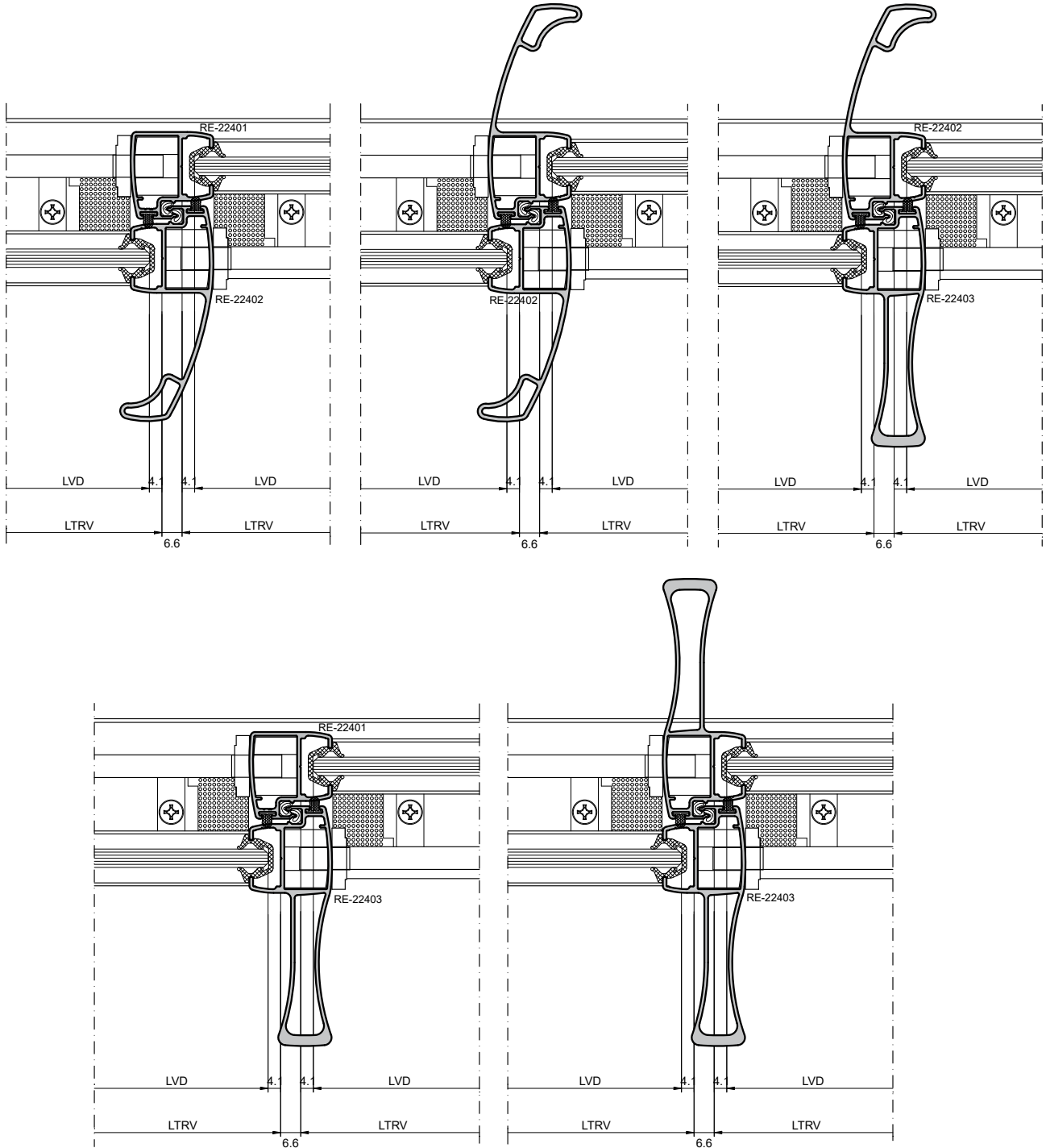

ESC.: 1:2

VEDAÇÃO COM QLON;

**MONTAGENS COM MONTANTES LATERAL
"MATA JUNTA" COM OPÇÃO DE PERFIL COM REFORÇO**

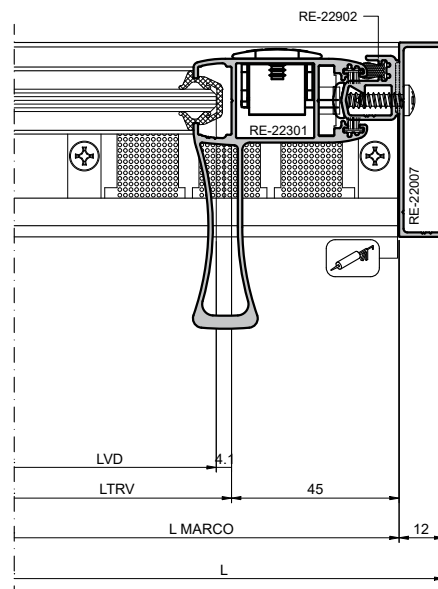
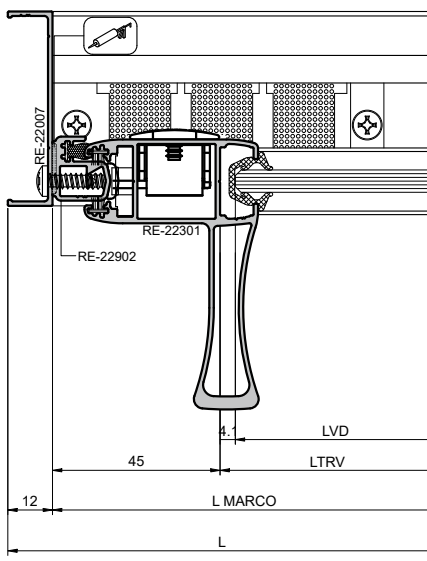
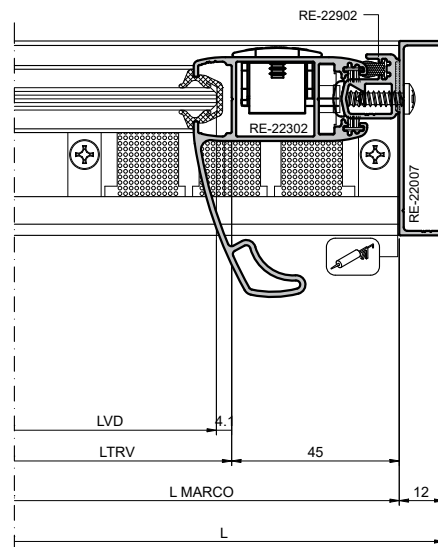
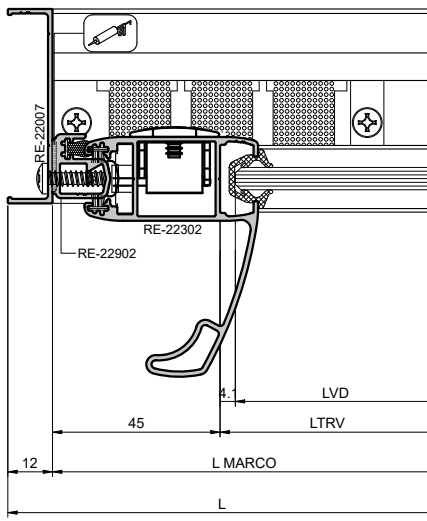
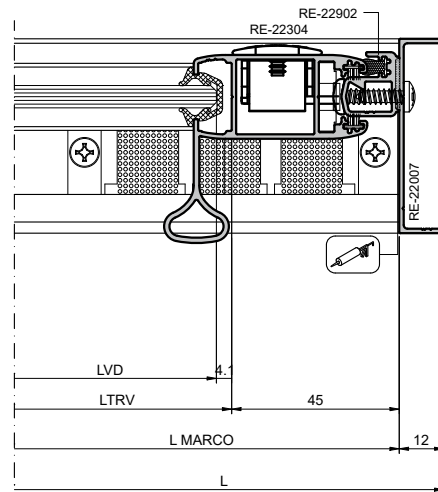
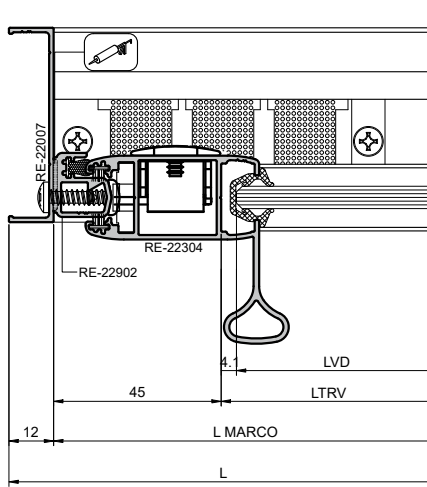

ESC.: 1:2

VEDAÇÃO COM ESCOVA COM BARREIRA PLÁSTICA;

MONTAGENS COM MONTANTES LATERAL "MATA JUNTA UNIFICADA COM MARCO LATERAL" COM OPÇÃO DE PERFIL COM REFORÇO

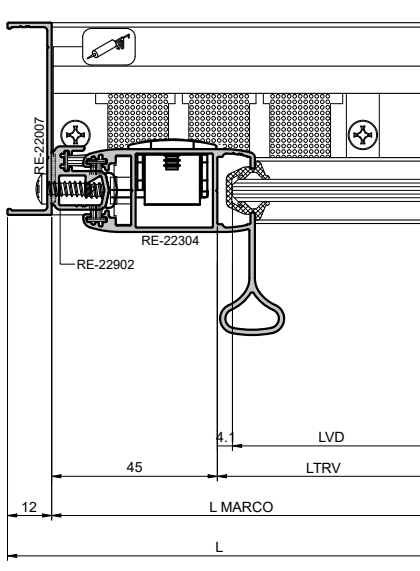

CORTE 03 A

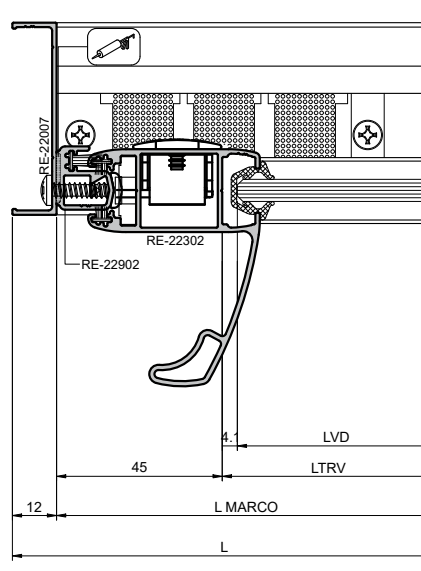

CORTE 03 A

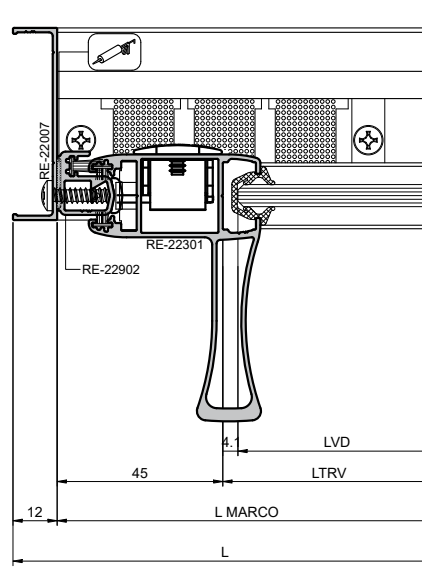

CORTE 03 A

ESC.: 1:2

VEDAÇÃO COM QLON;

**MONTAGENS COM MONTANTES LATERAL
 "MATA JUNTA UNIFICADA COM MARCO LATERAL"
 COM OPÇÃO DE PERFIL COM REFORÇO OU SEM ESFORÇO**

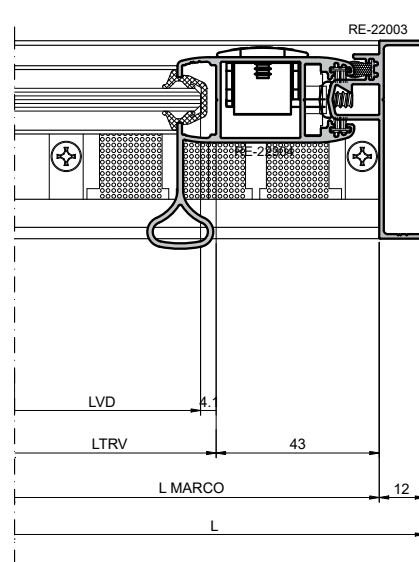
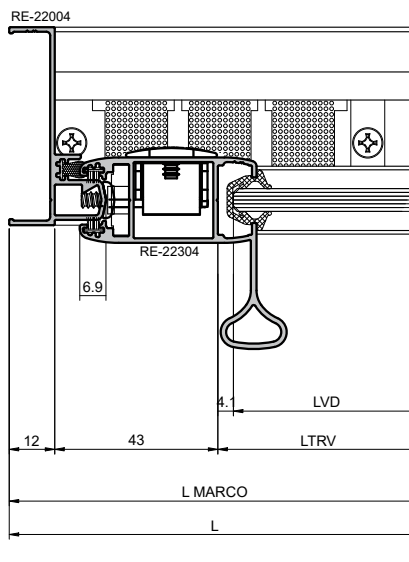
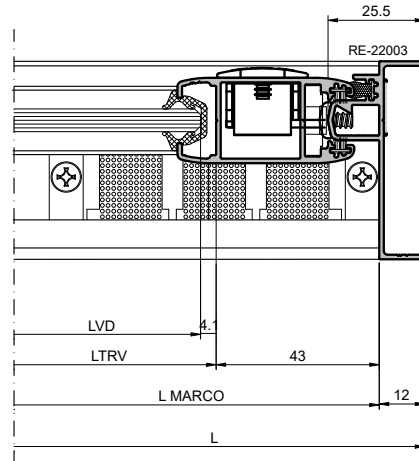
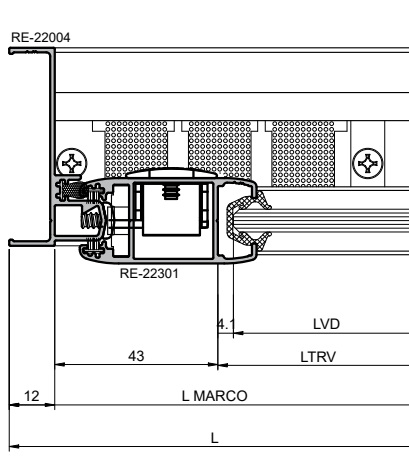

MONTAGENS COM MONTANTES LATERAL “MATA JUNTA UNIFICADA COM MARCO LATERAL” COM OPÇÃO DE PERFIL COM REFORÇO OU SEM ESFORÇO

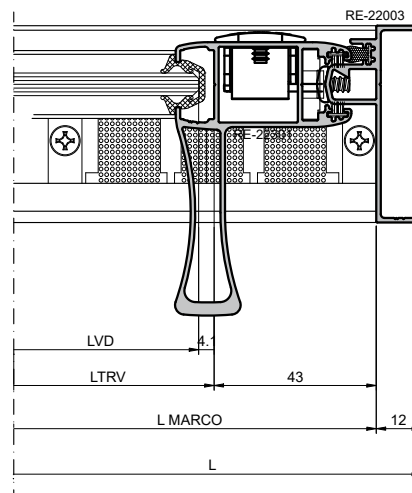
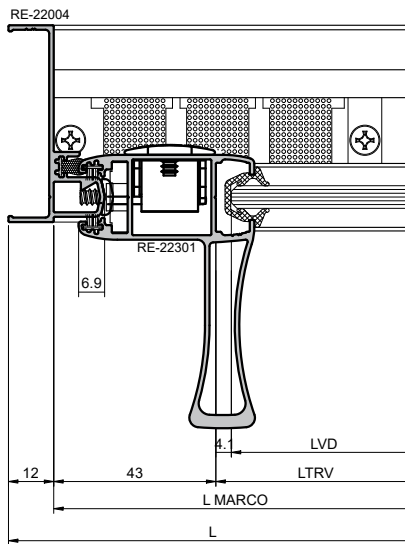
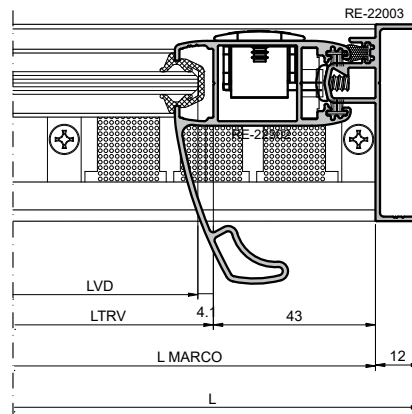
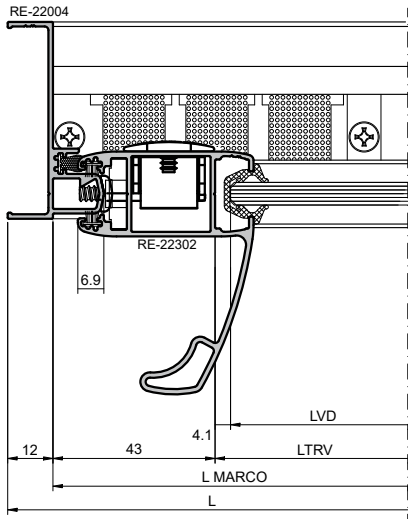

**MONTAGENS COM CENTRAL
"MATA JUNTA" COM OPÇÃO DE PERFIL COM REFORÇO**

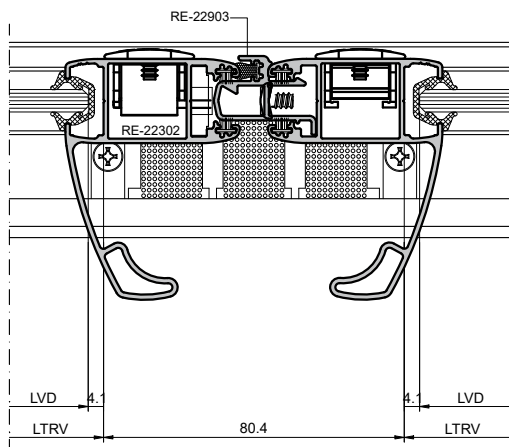
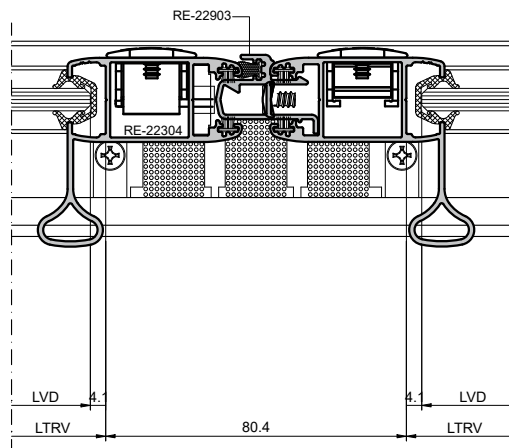
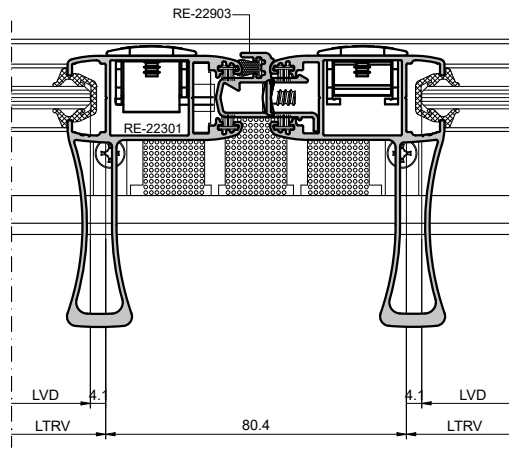

ESC.: 1:2

MONTAGENS COM PERFIL DE TRILHO INFERIOR

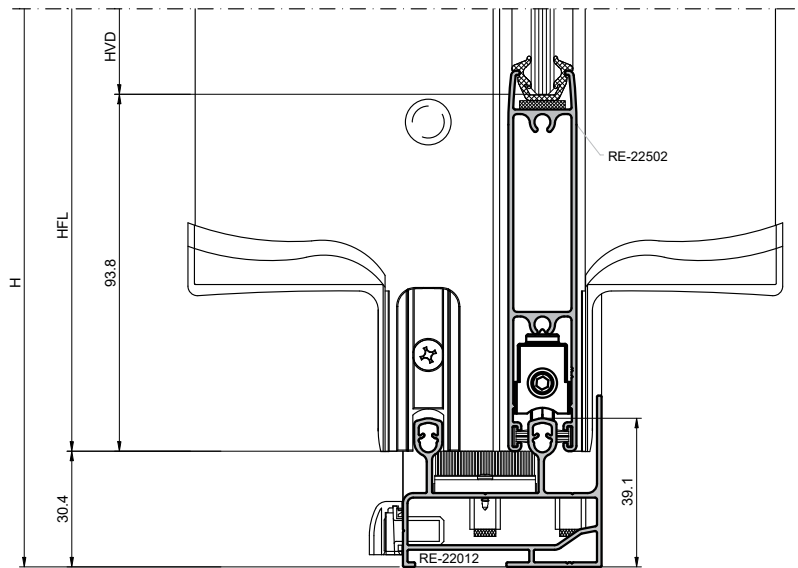
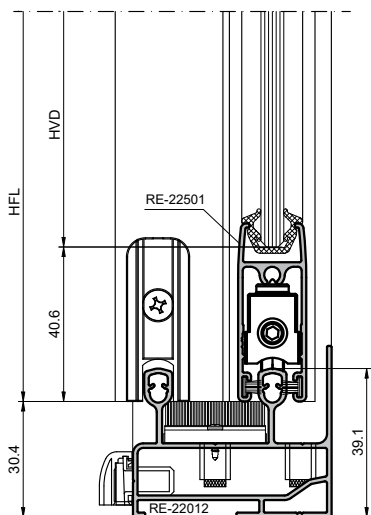
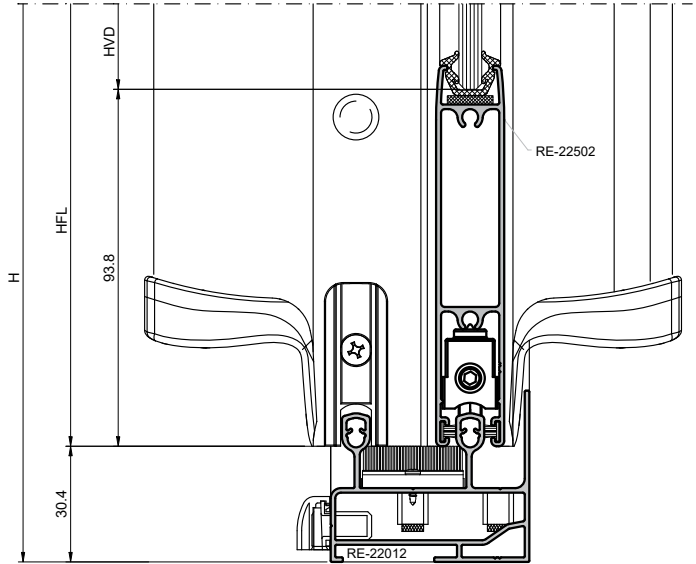
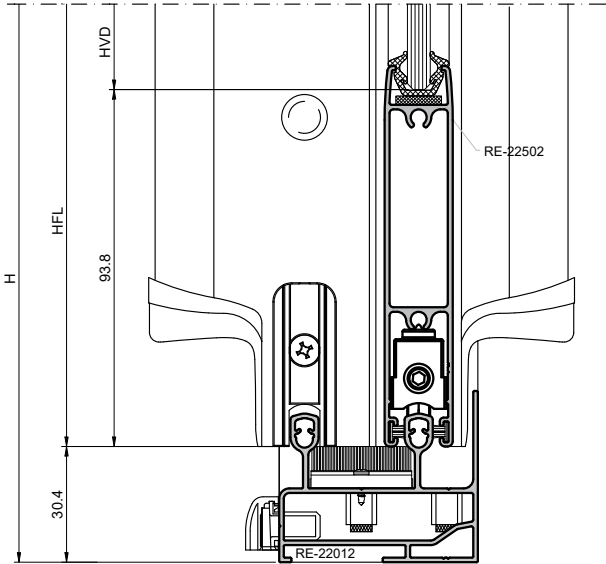

ESC.: 1:2

**MONTAGENS COM PERFIL DE TRILHO SUPERIOR
2 TRILHOS PARA 2 FOLHAS E TRAVESSA INTERMEDIÁRIA**

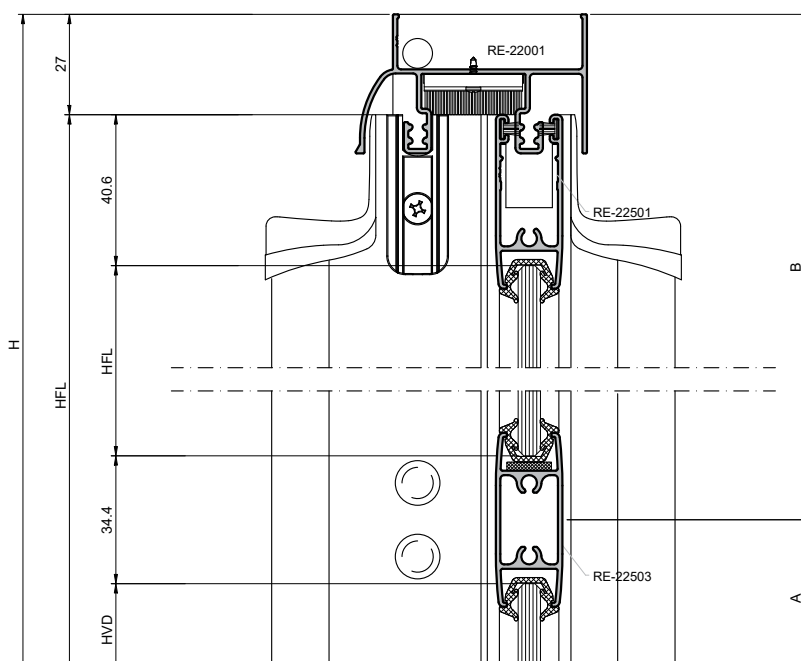
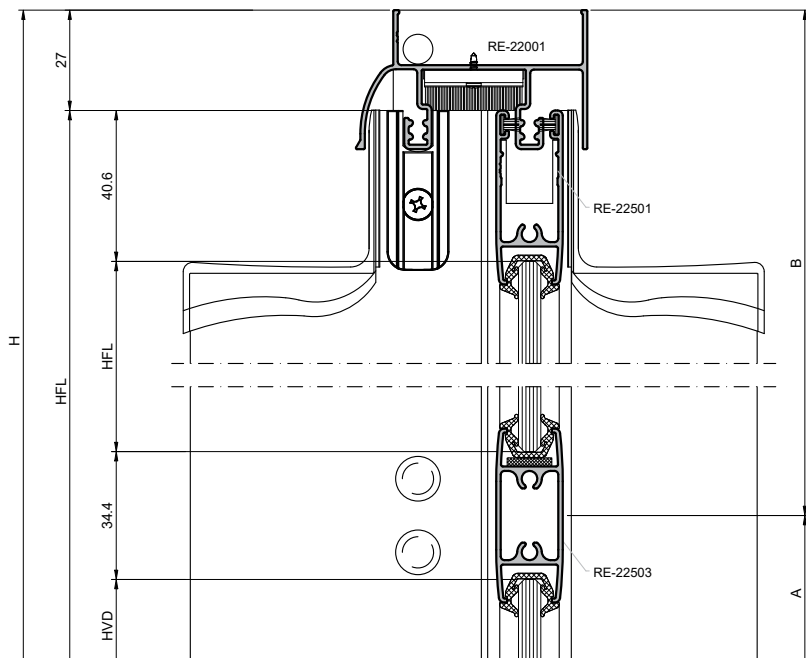

ESC.: 1:2

MONTAGENS COM PERFIL DE TRILHO SUPERIOR 2 TRILHOS PARA 2 FOLHAS E TRAVESSA INTERMEDIÁRIA

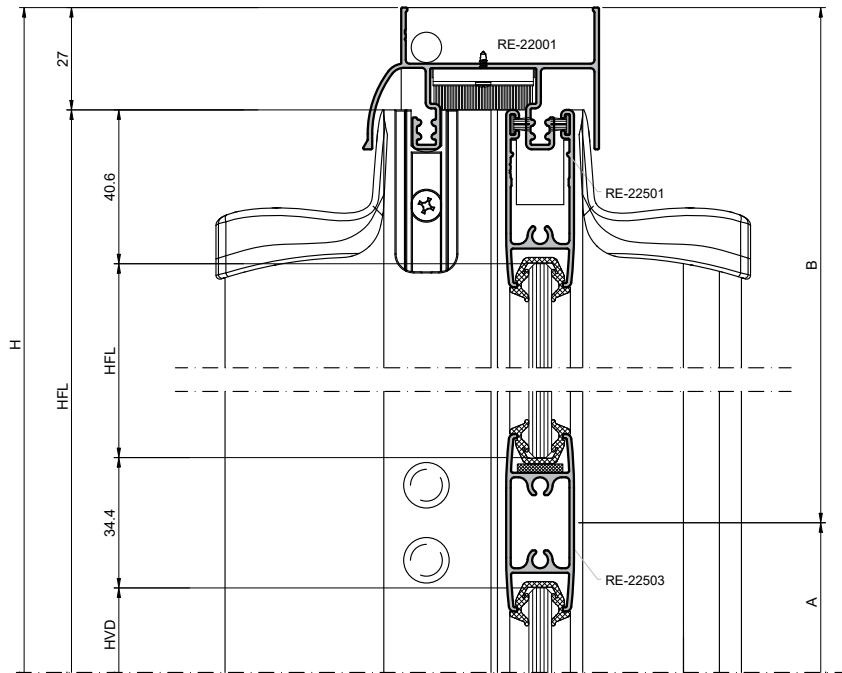

**CAIXA PERSIANA INTEGRADA REDONDA
"JANELA" COM RECOLHEDOR MANUAL EIXO DE 40MM
E TRILHOS SUPERIOR RE-22201**

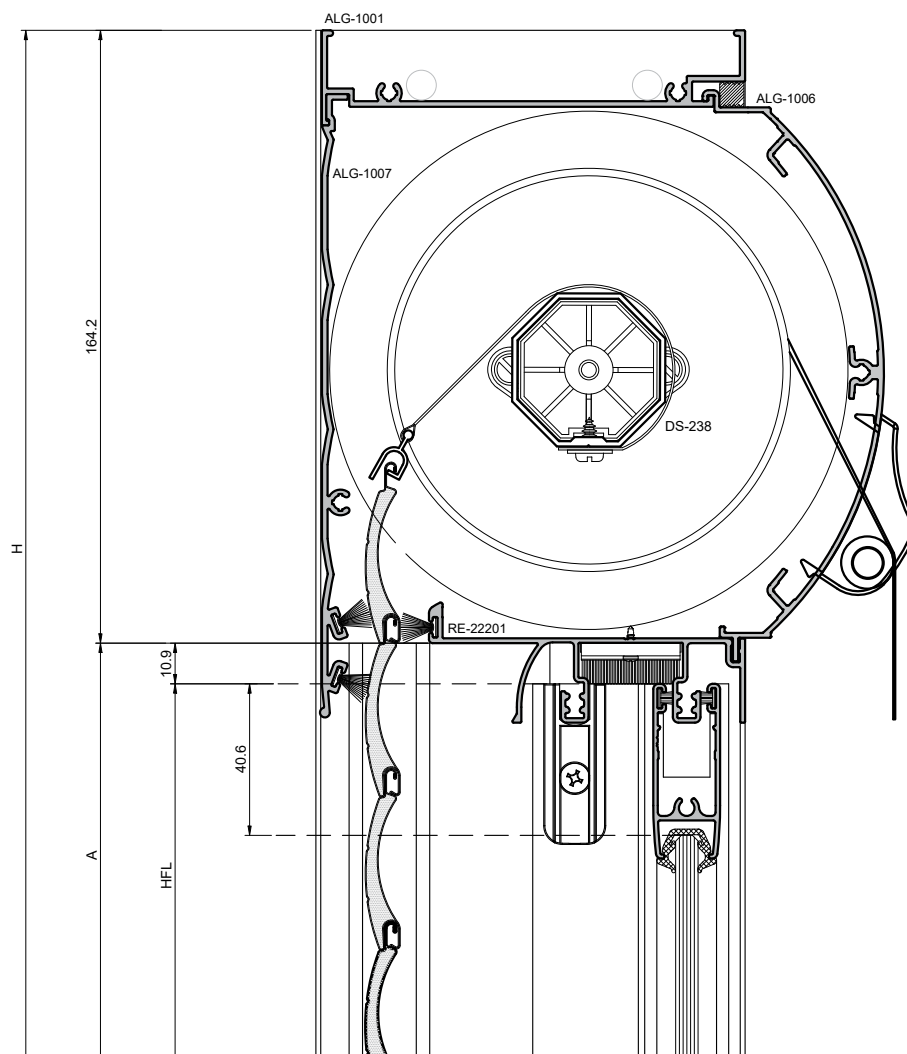

ESC.: 1:2

**CAIXA PERSIANA INTEGRADA REDONDA "JANELA"
COM RECOLHEDOR MANUAL EIXO DE 40MM E
TRILHOS SUPERIOR RE-22201**

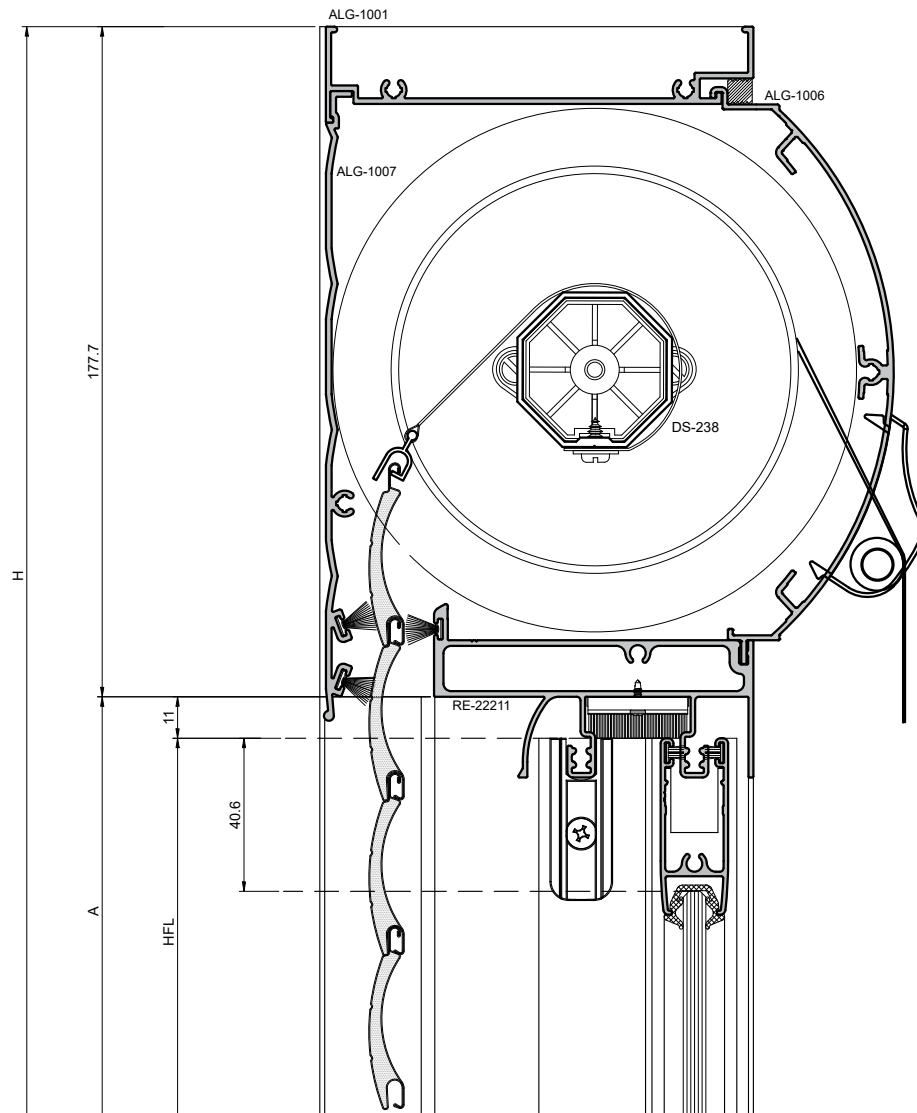

CAIXA PERSIANA INTEGRADA REDONDA "JANELA" COM MOTOR E EIXO DE 40MM E TRILHOS SUPERIOR RE-22201

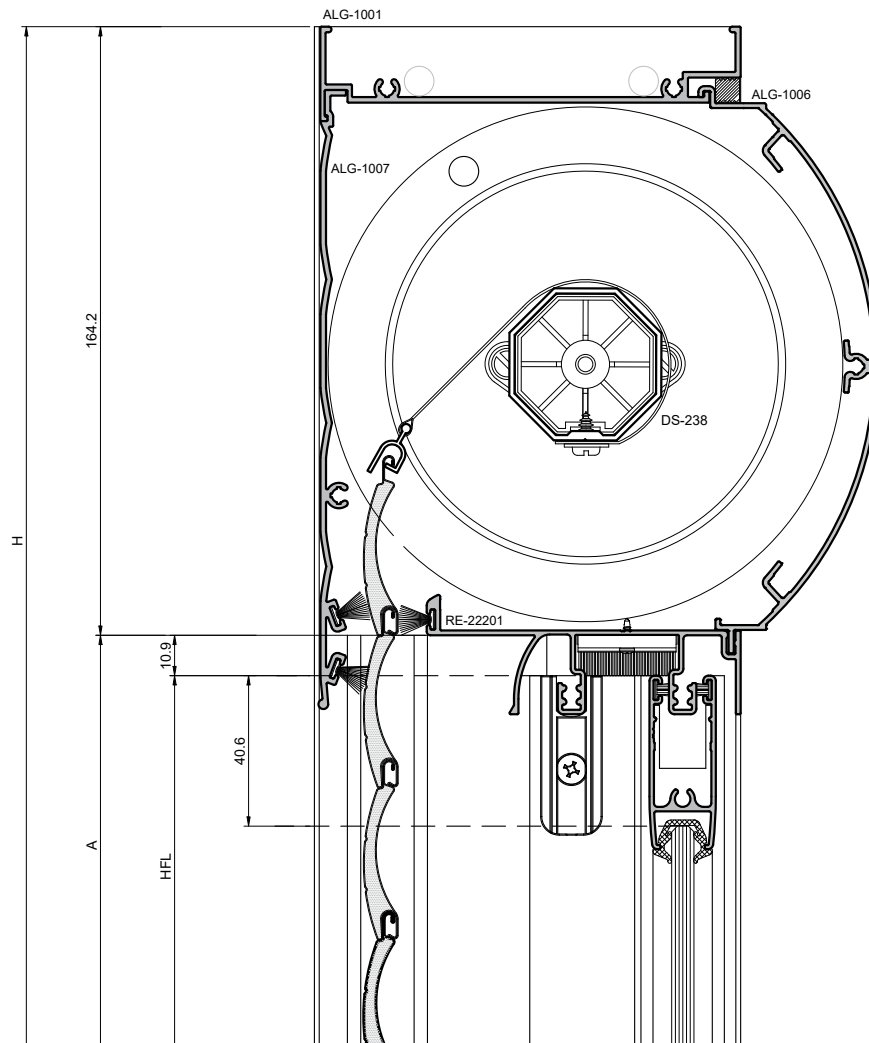

CAIXA PERSIANA INTEGRADA REDONDA "JANELA" COM MOTOR E EIXO DE 40MM E TRILHOS SUPERIOR RE-22211

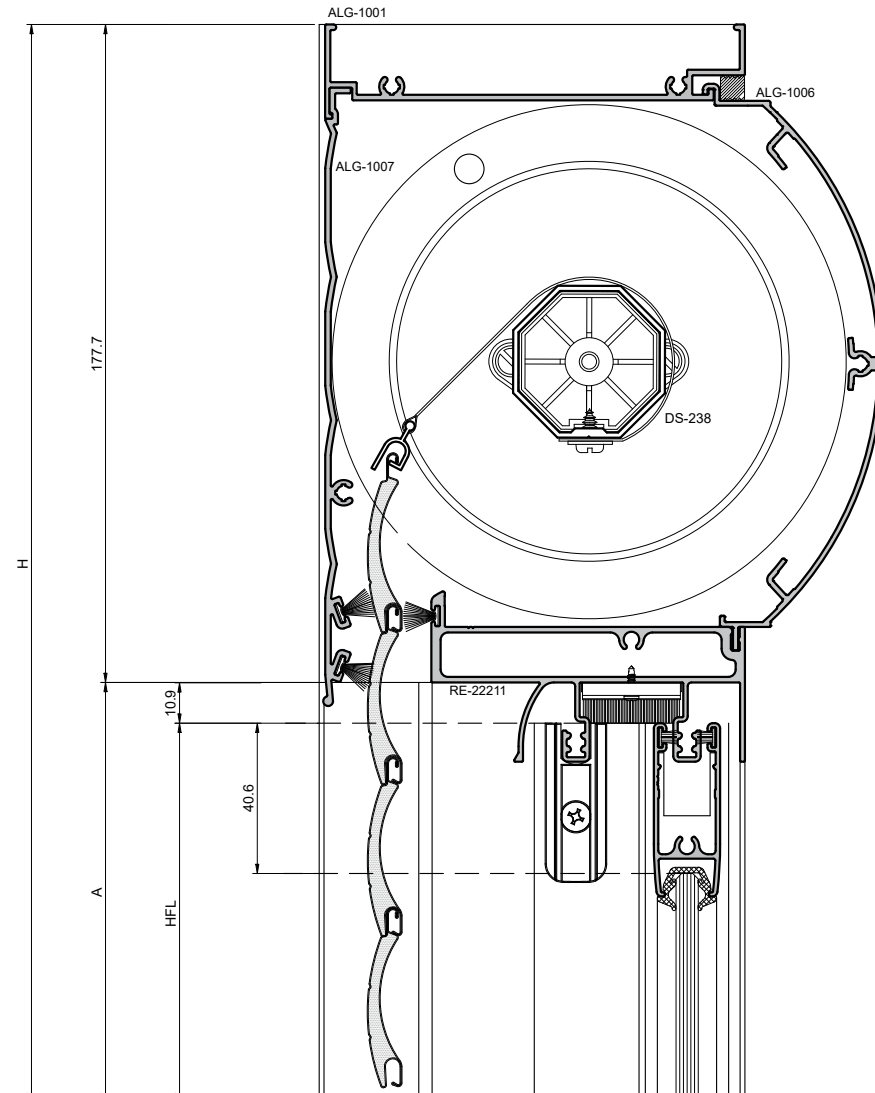

**CAIXA PERSIANA INTEGRADA REDONDA "JANELA"
COM RECOLHEDOR MANUAL EIXO DE 60MM E
TRILHOS SUPERIOR RE-22201**

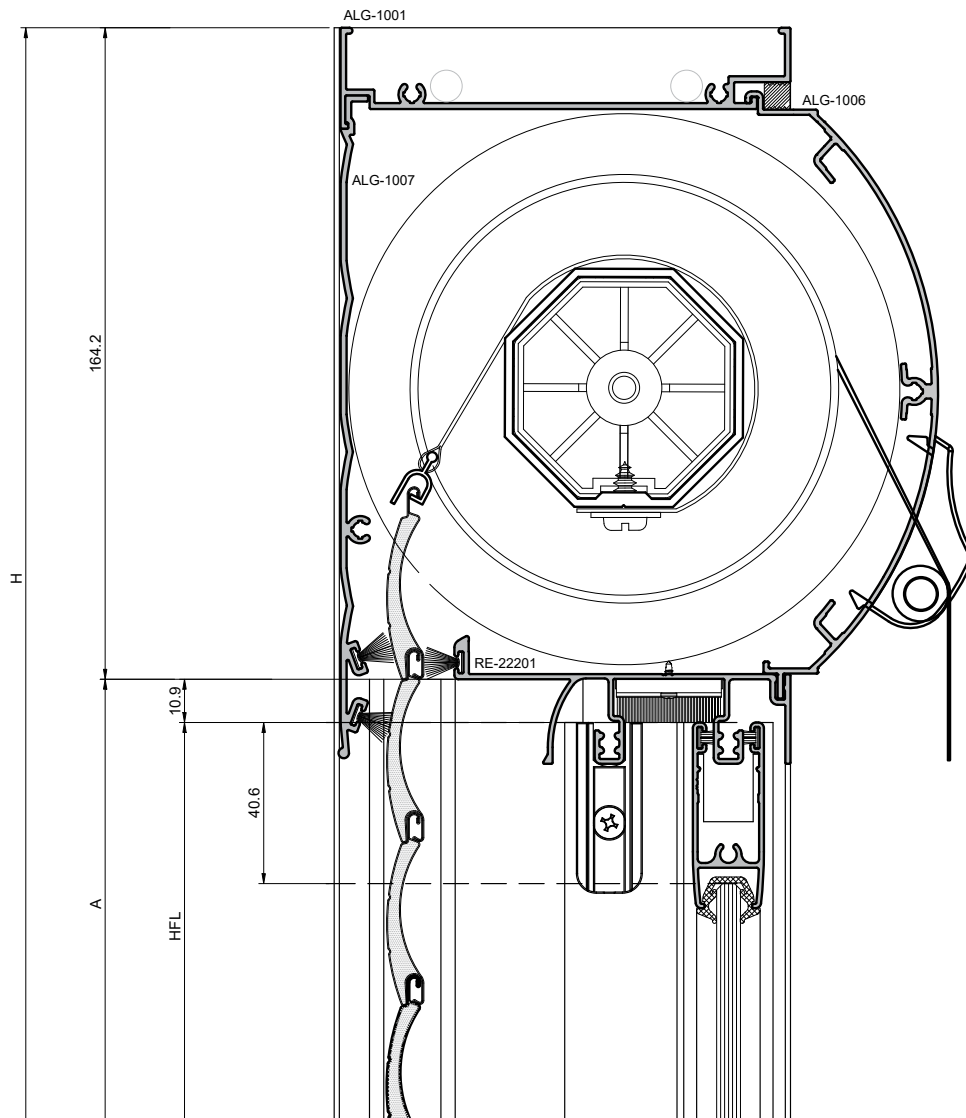

**CAIXA PERSIANA INTEGRADA REDONDA "JANELA"
COM RECOLHEDOR MANUAL EIXO DE 60MM E
TRILHOS SUPERIOR RE-22211**

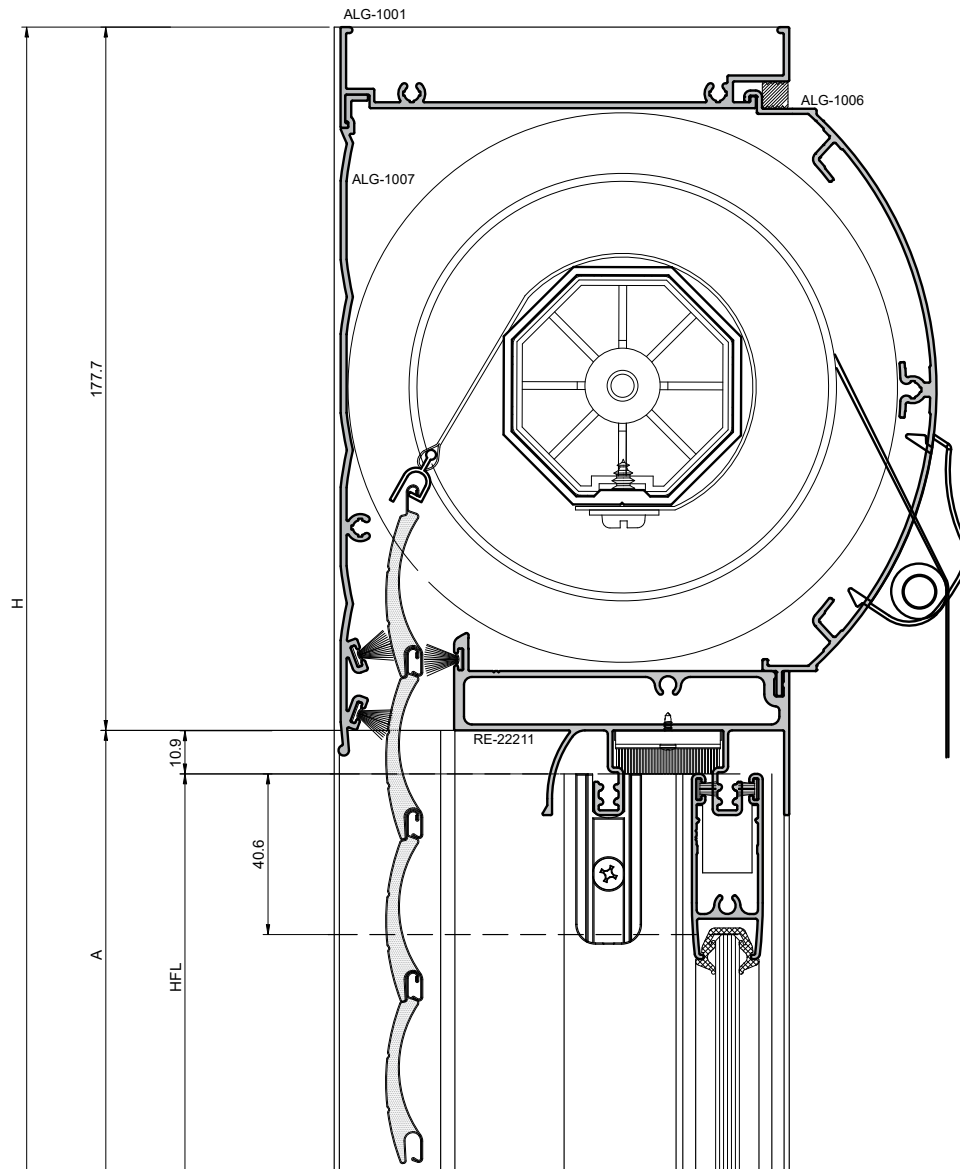

**CAIXA PERSIANA INTEGRADA REDONDA "JANELA"
COM RECOLHEDOR DE MOTOR EIXO DE 60MM E
TRILHOS SUPERIOR RE-22201**

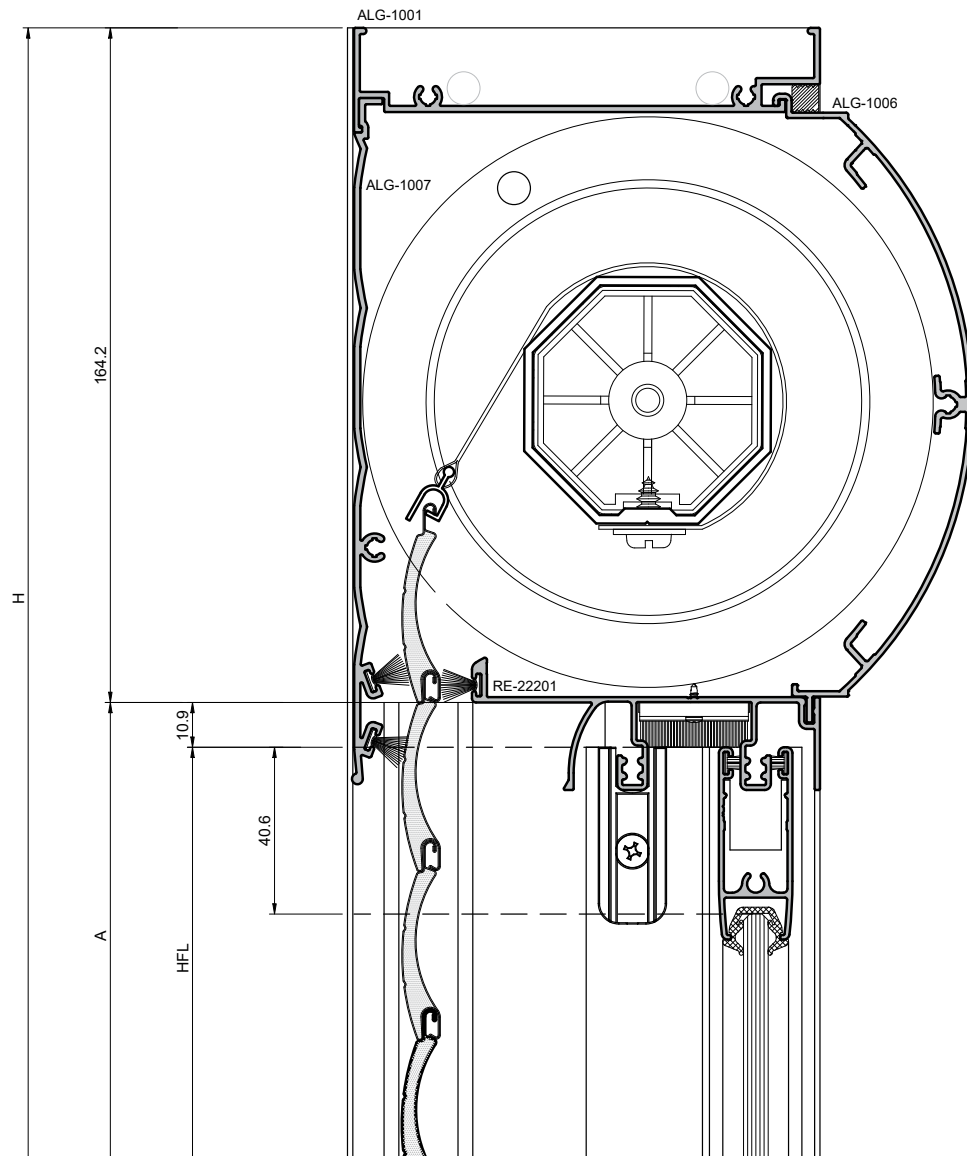

**CAIXA PERSIANA INTEGRADA REDONDA "JANELA"
COM RECOLHEDOR DE MOTOR E EIXO DE 60MM E
TRILHOS SUPERIOR RE-22211**

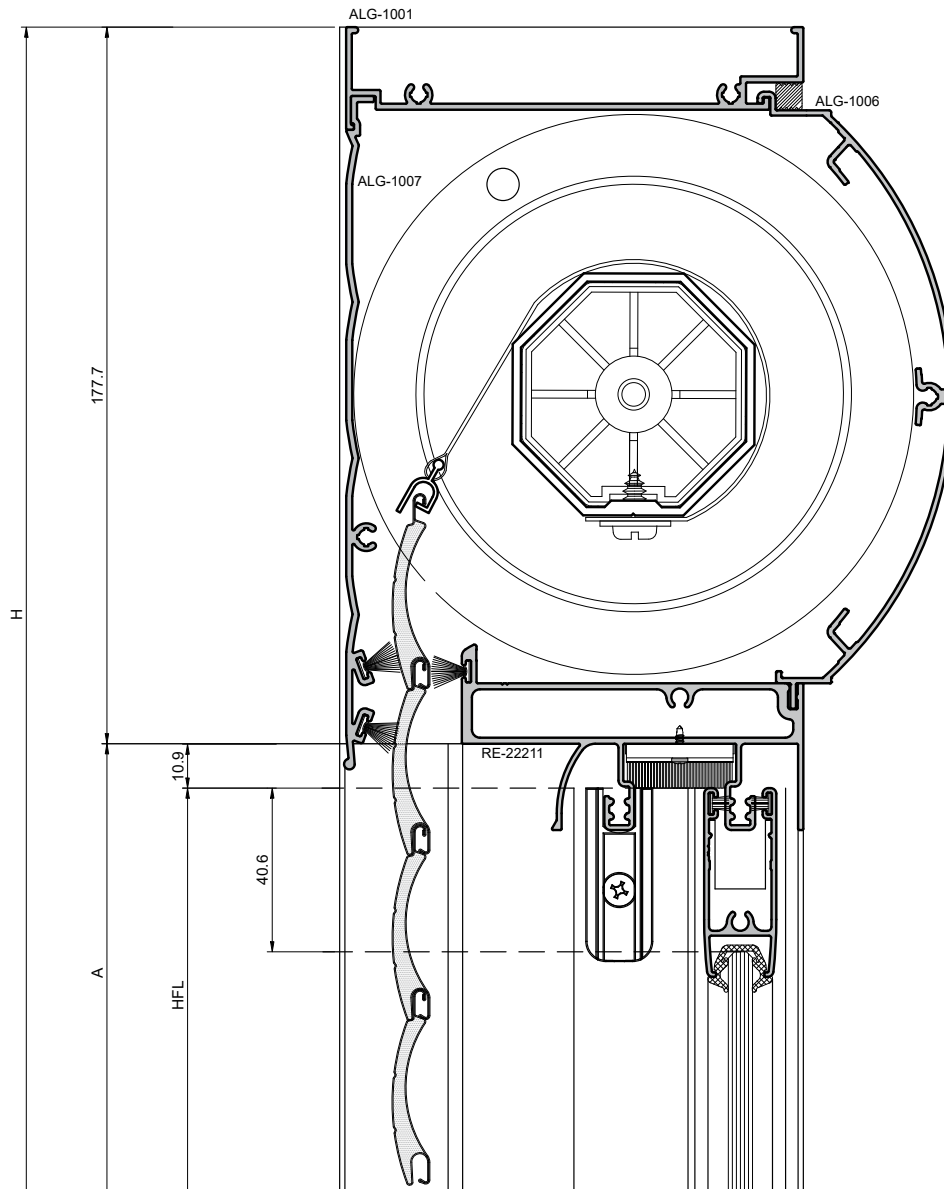

**CAIXA PERSIANA INTEGRADA REDONDA "PORTA"
COM RECOLHEDOR MANUAL EIXO DE 40MM E
TRILHOS SUPERIOR RE-22201**

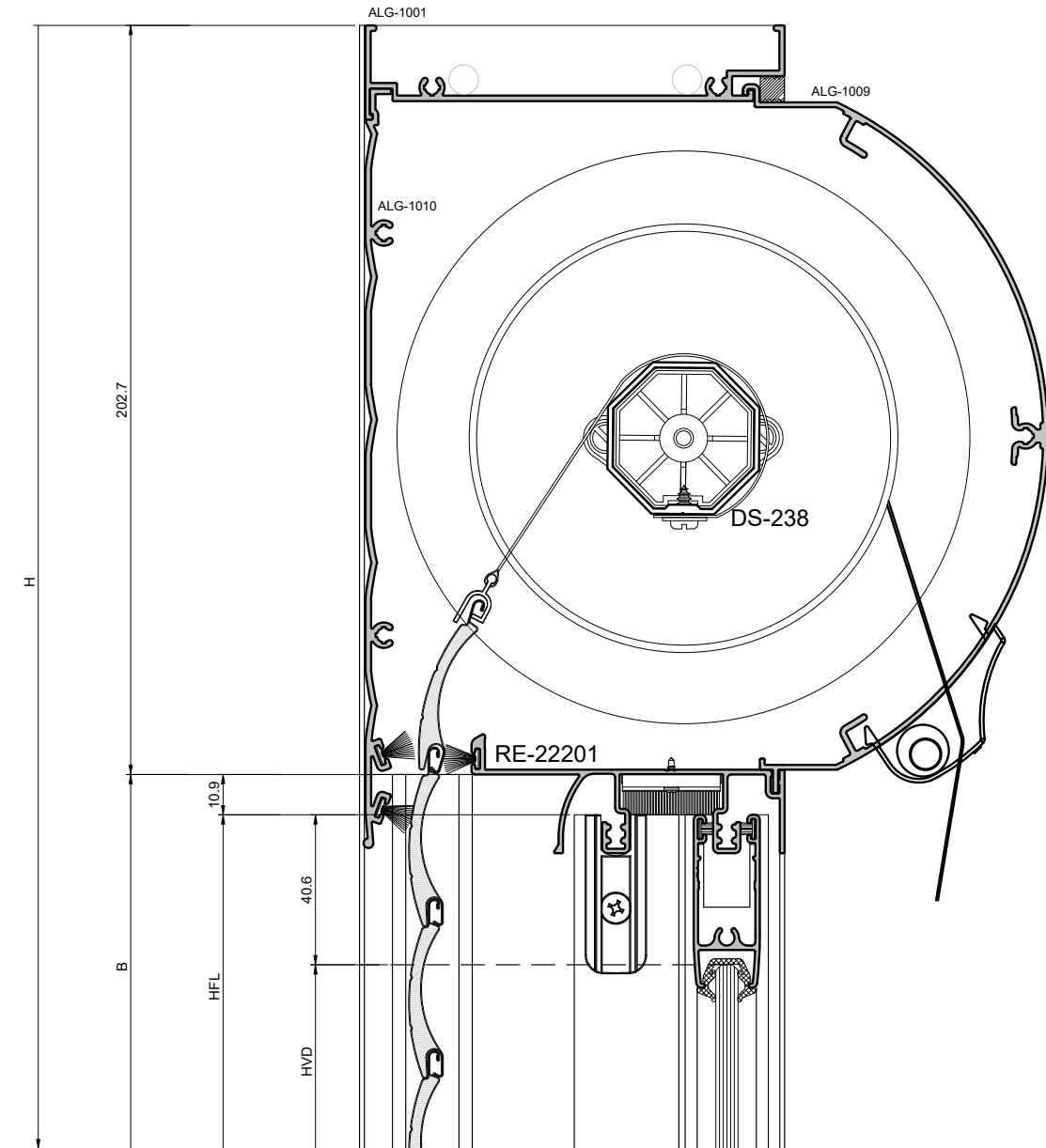

**CAIXA PERSIANA INTEGRADA REDONDA
"PORTA" COM RECOLHEDOR MANUAL EIXO DE
40MM E TRILHOS SUPERIOR RE-22211**

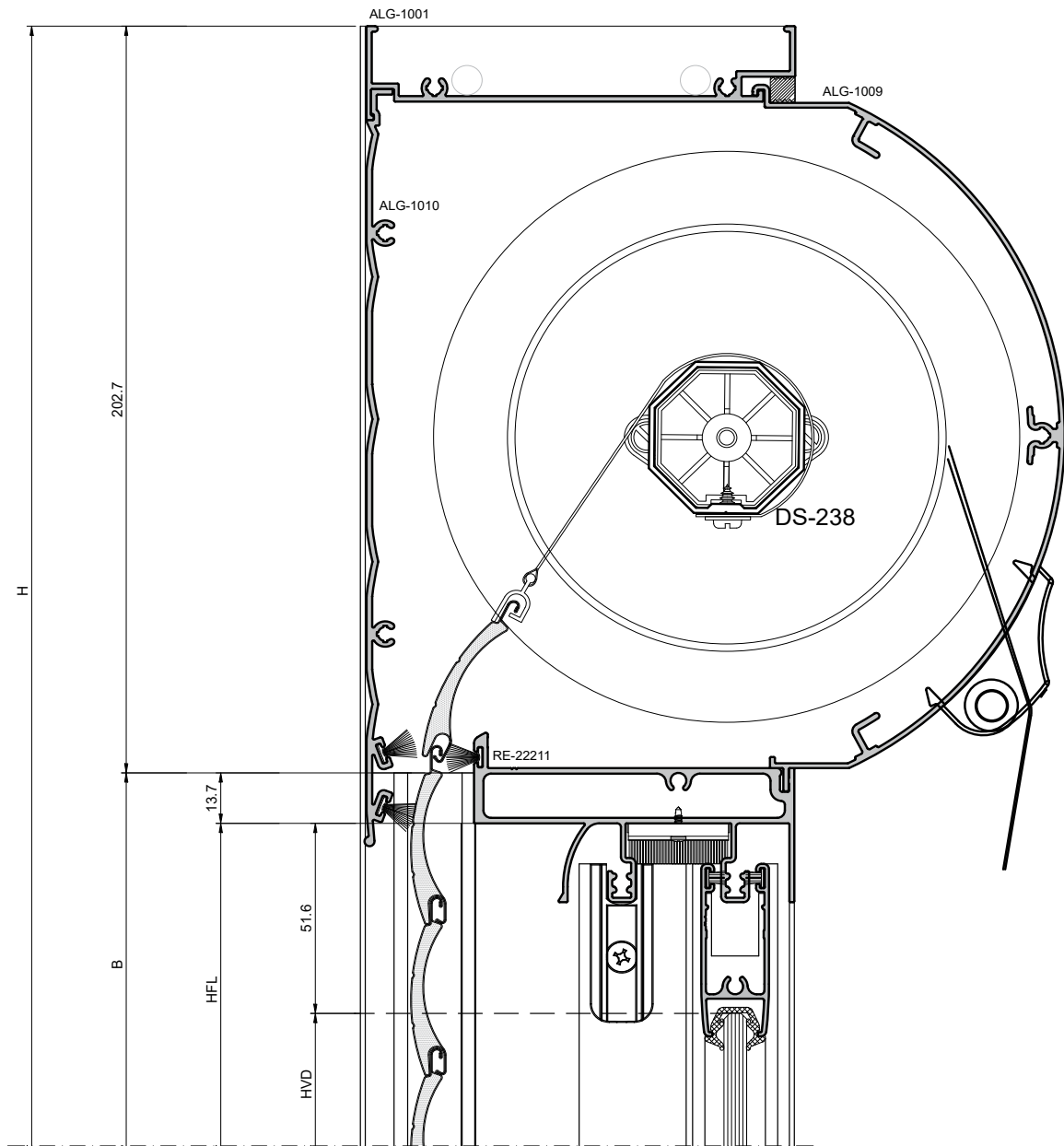

**CAIXA PERSIANA INTEGRADA REDONDA
"PORTA" COM MOTOR E EIXO DE 40MM E TRILHOS
SUPERIOR RE-22201**

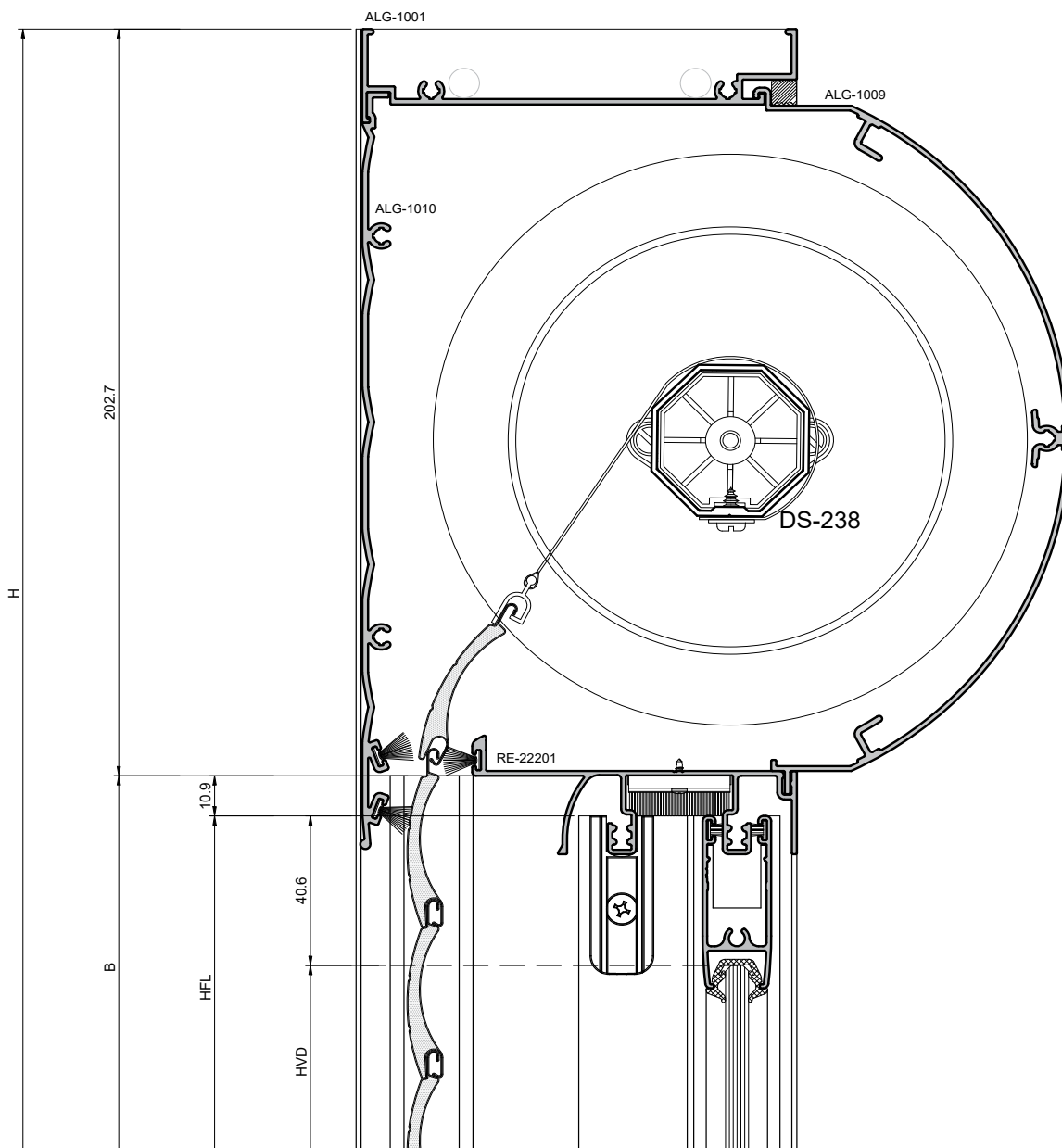

**CAIXA PERSIANA INTEGRADA REDONDA "PORTA"
COM MOTOR E EIXO DE 40MM E TRILHOS SUPERIOR
RE-22211**

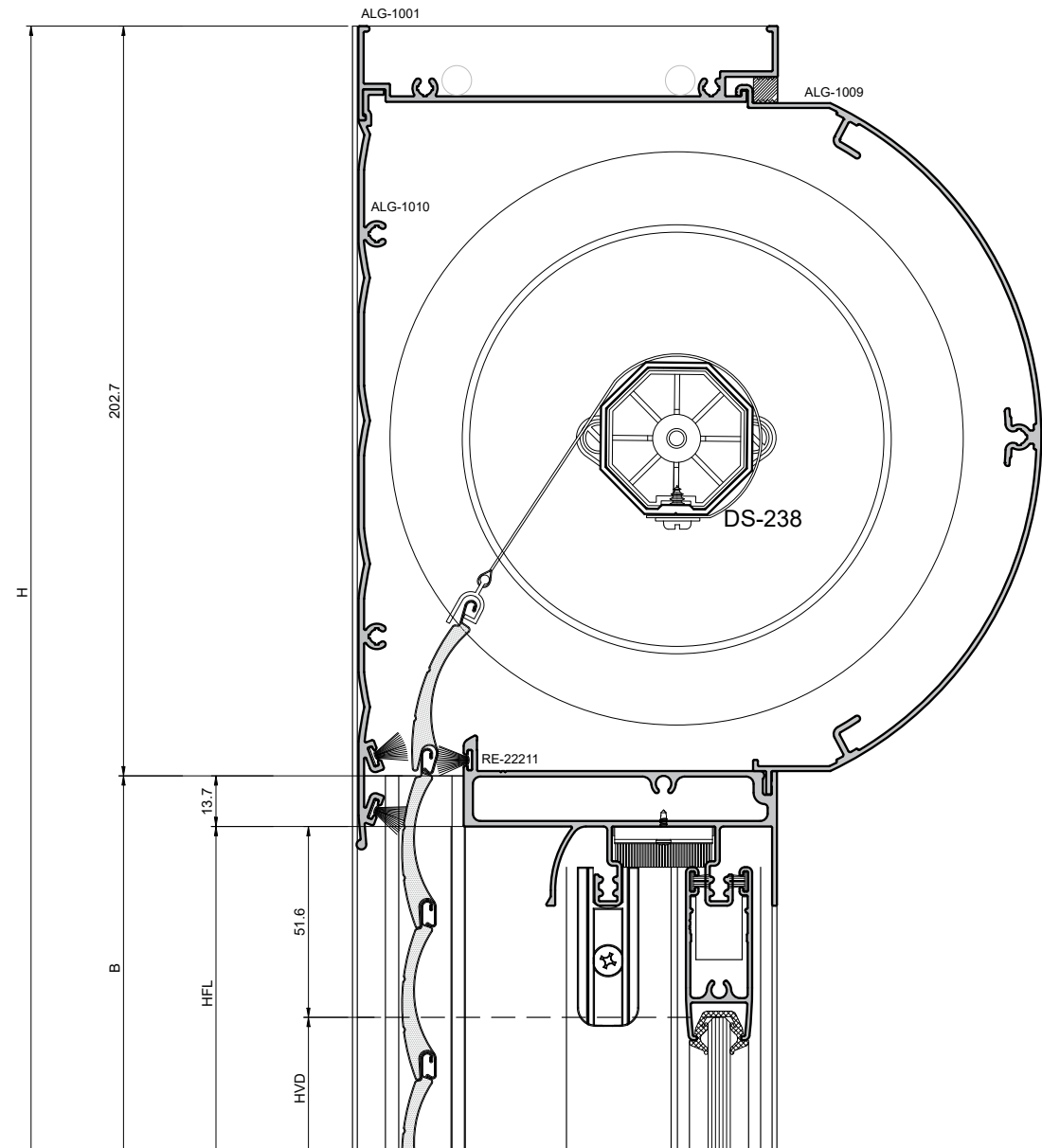

**CAIXA PERSIANA INTEGRADA REDONDA "PORTA"
COM RECOLHEDOR MANUAL EIXO DE 60MM E
TRILHOS SUPERIOR RE-22201**

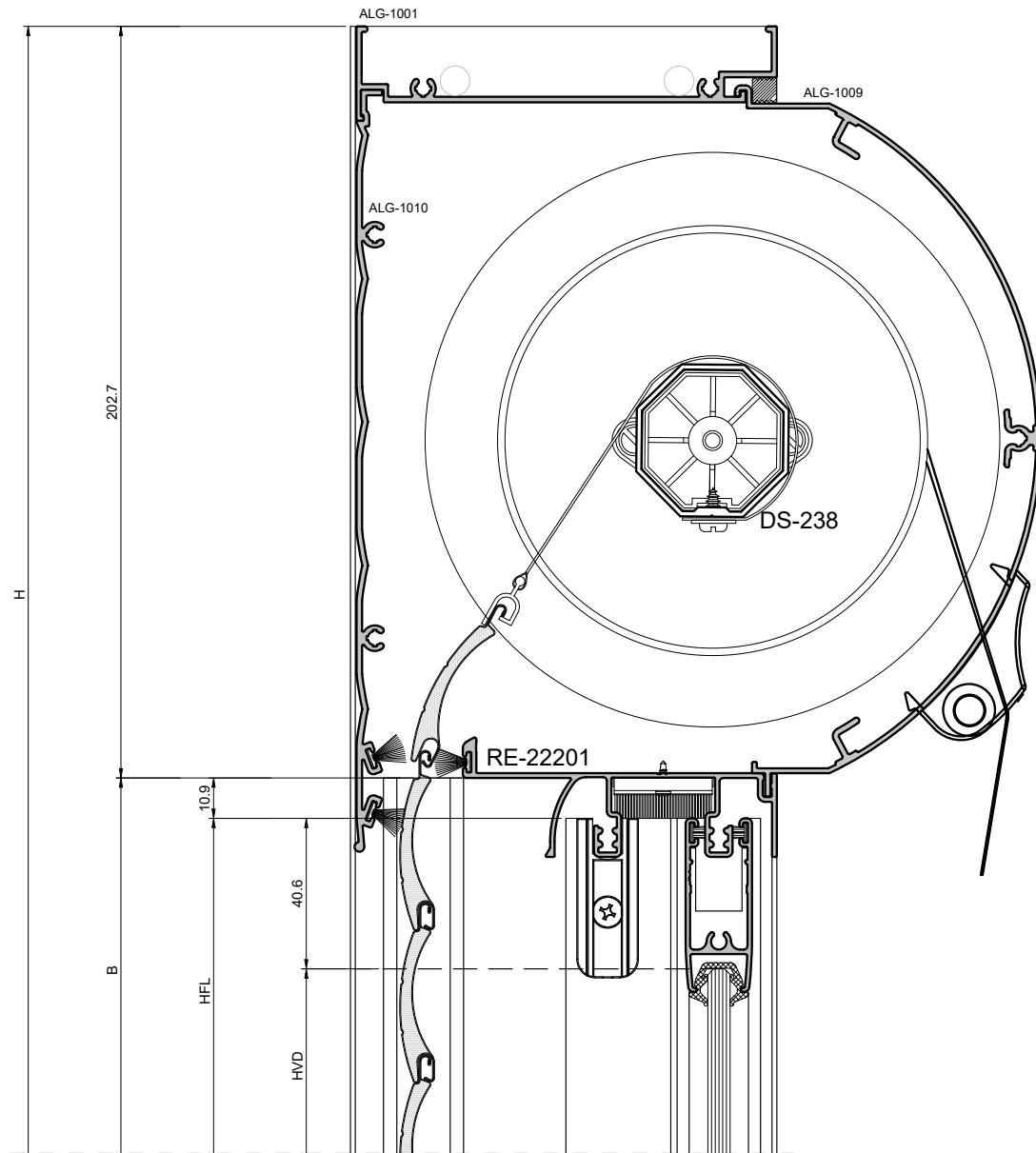

**CAIXA PERSIANA INTEGRADA REDONDA "PORTA"
COM RECOLHEDOR MANUAL EIXO DE 60MM E
TRILHOS SUPERIOR RE-22211**

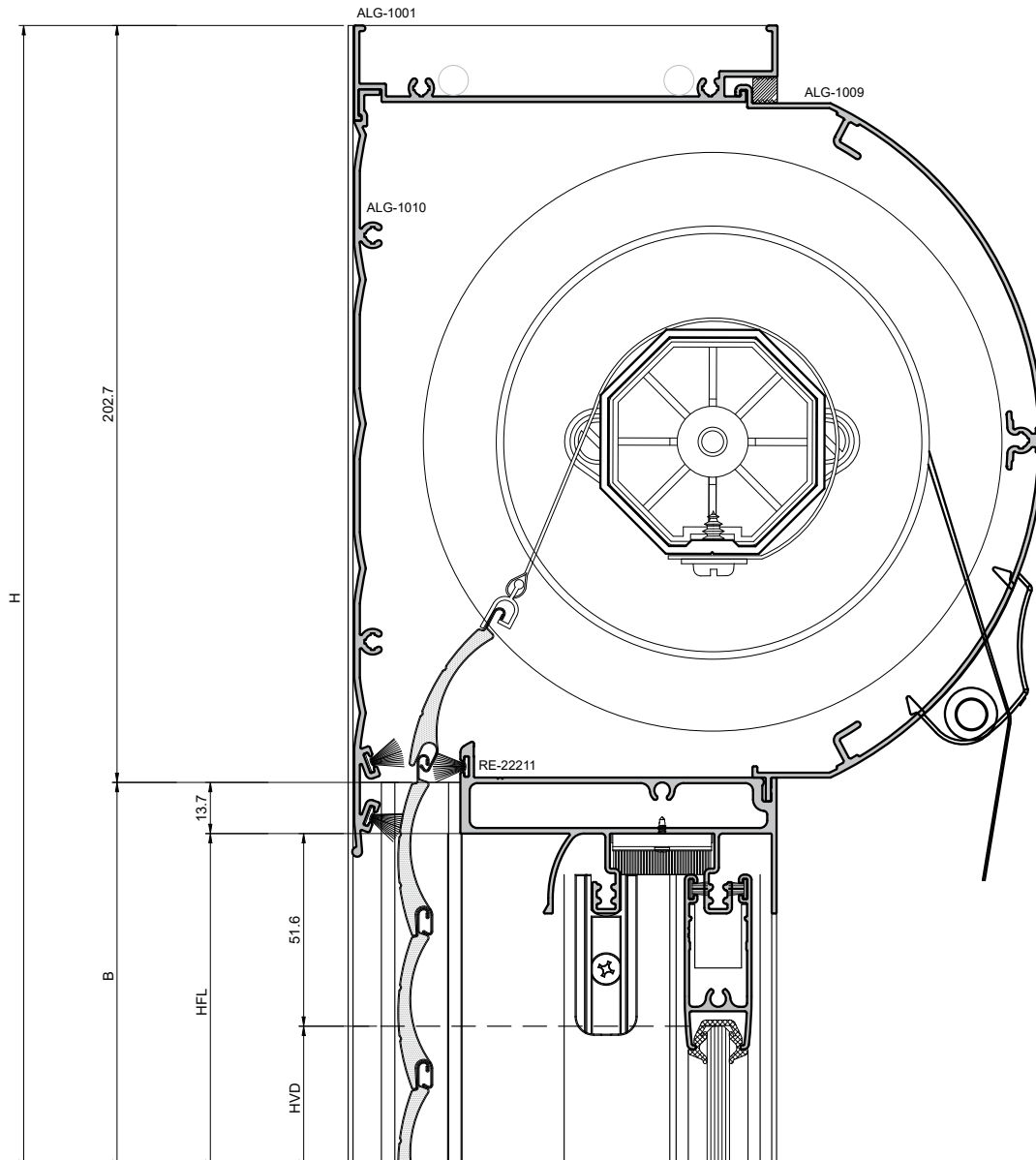

**CAIXA PERSIANA INTEGRADA REDONDA "PORTA"
COM RECOLHEDOR DE MOTOR E EIXO DE 60MM E
TRILHOS SUPERIOR RE-22201**

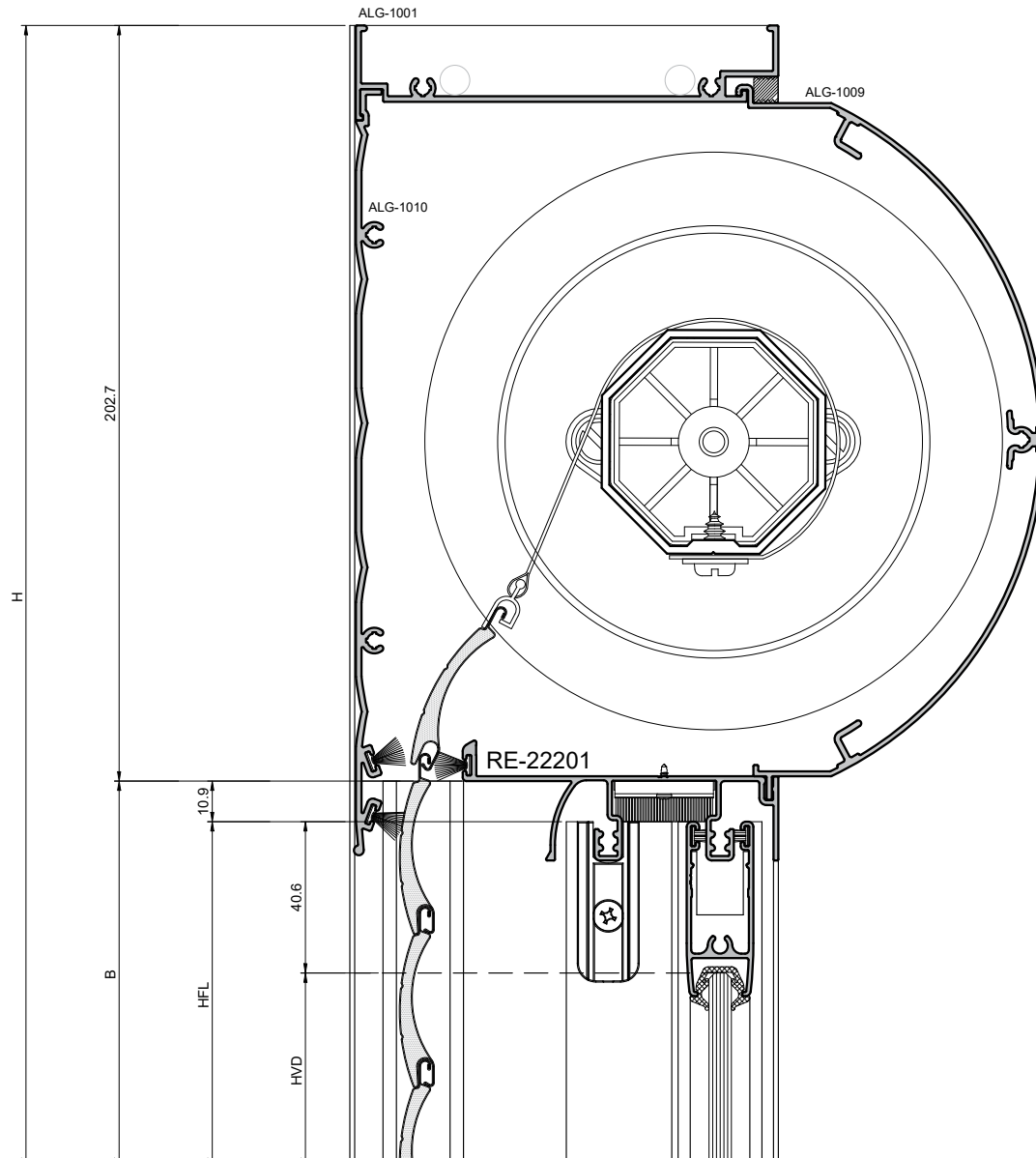

**CAIXA PERSIANA INTEGRADA REDONDA "PORTA"
COM RECOLHEDOR DE MOTOR E EIXO DE 60MM E
TRILHOS SUPERIOR RE-22211**

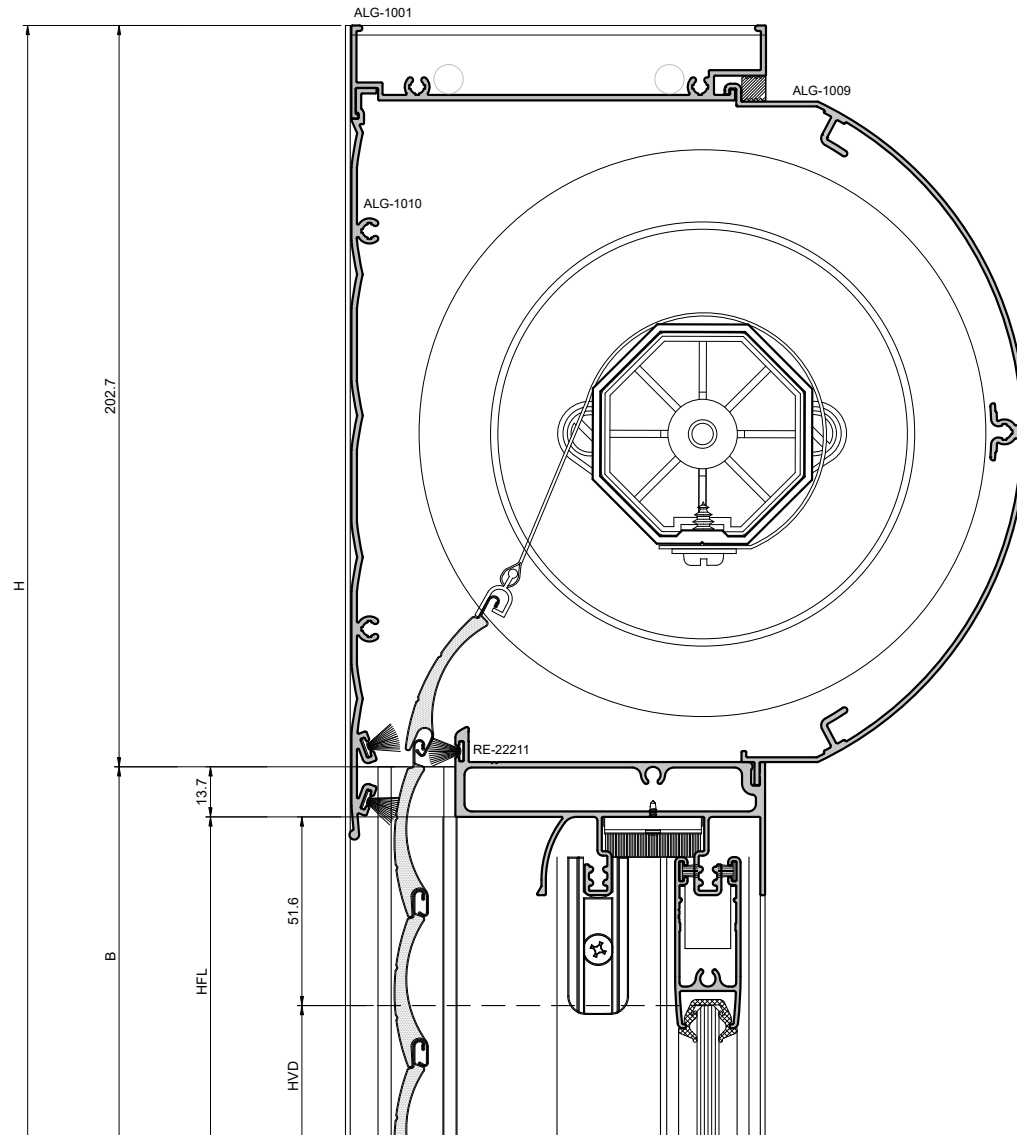

ESC.: 1:2

MONTAGENS COM 3 PLANOS COM MONTANTES LATERAL E CENTRAL COM OPÇÃO DE PERFIL COM REFORÇO

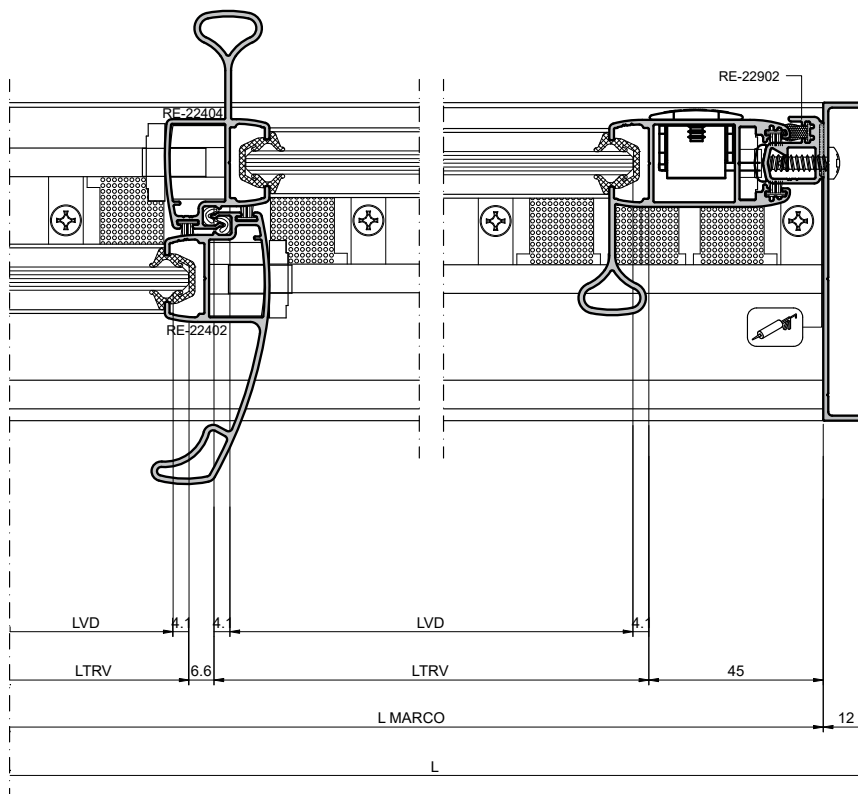
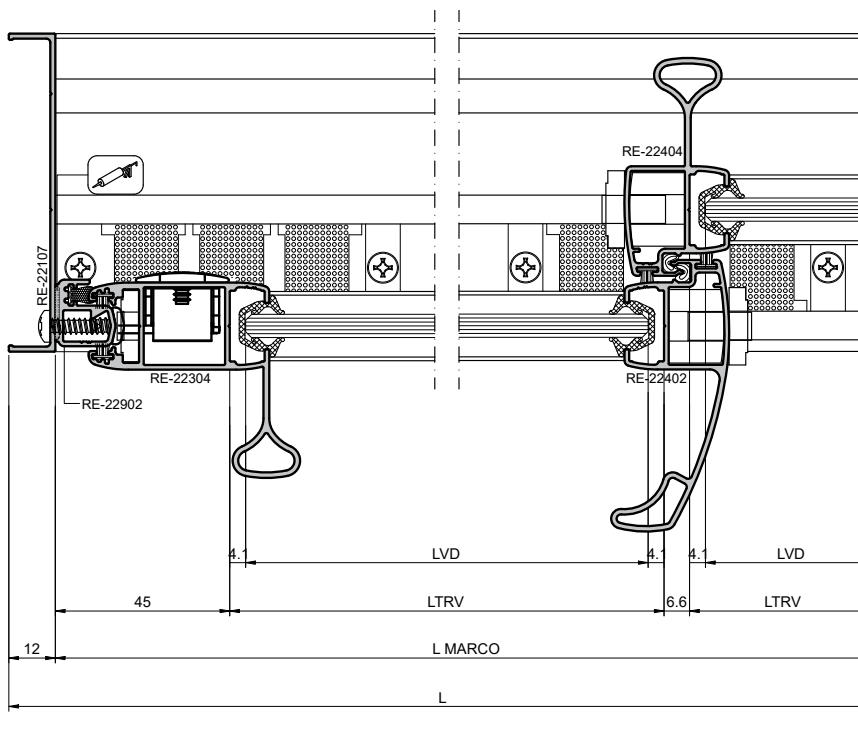

ESC.: 1:2

MONTAGENS COM 3 PLANOS COM MONTANTES LATERAL E CENTRAL COM OPÇÃO DE PERFIL COM REFORÇO

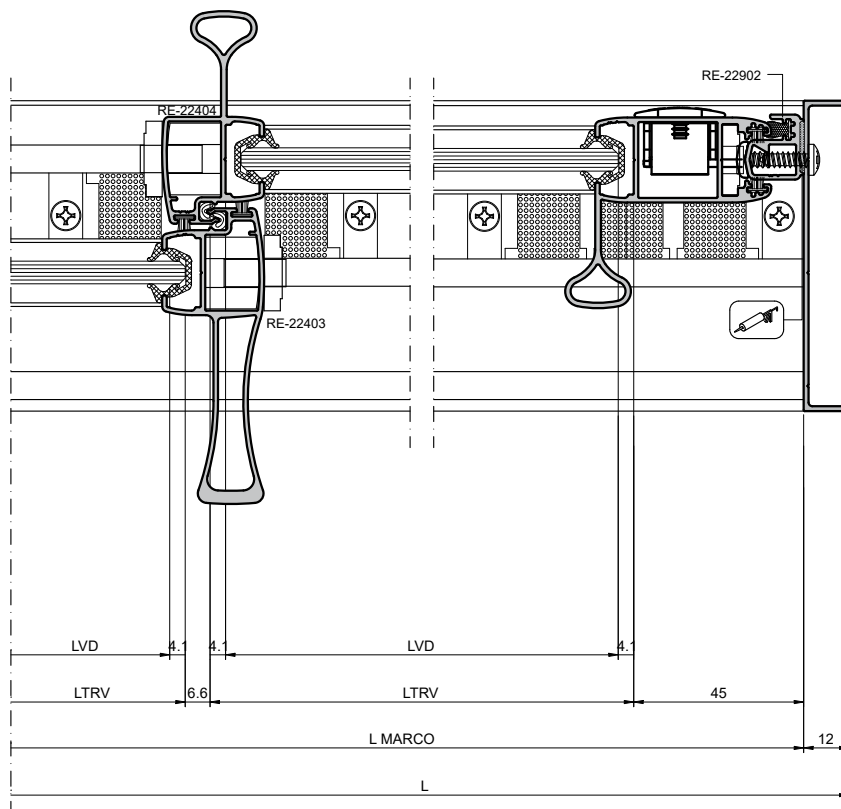
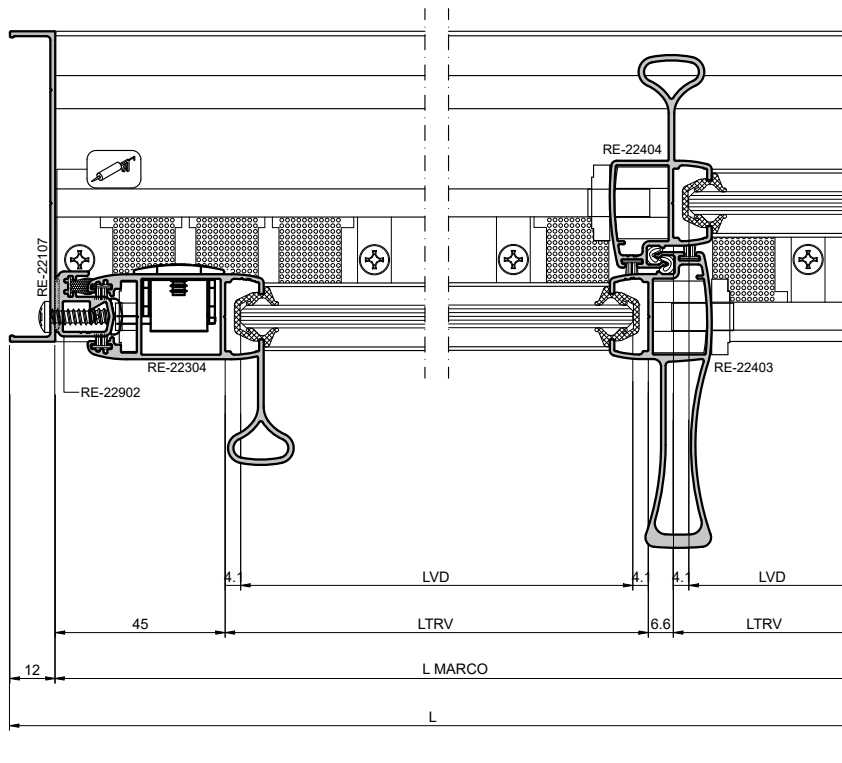

ESC.: 1:2

MONTAGENS COM 3 PLANOS COM MONTANTES LATERAL E CENTRAL COM OPÇÃO DE PERFIL COM REFORÇO

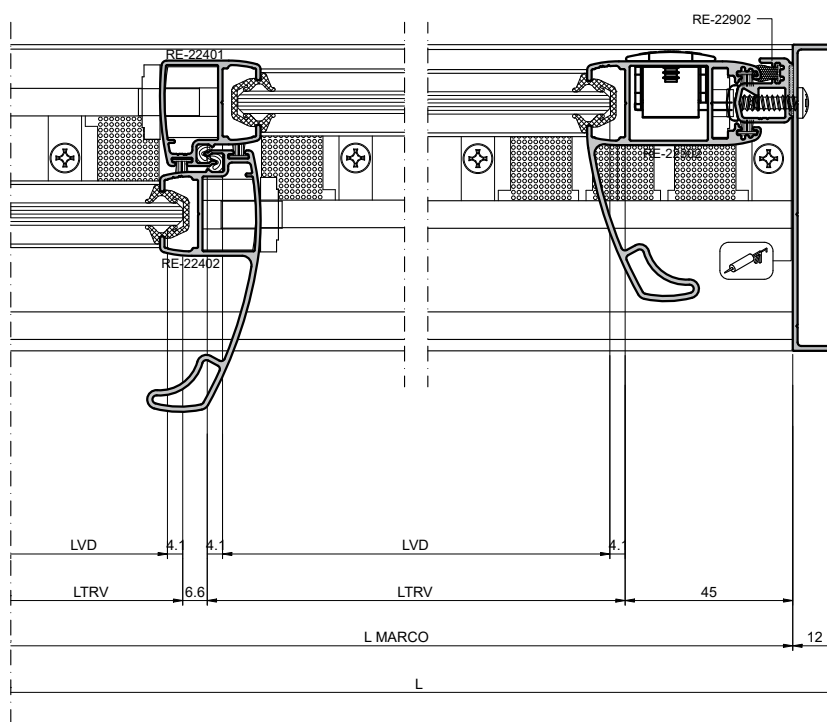
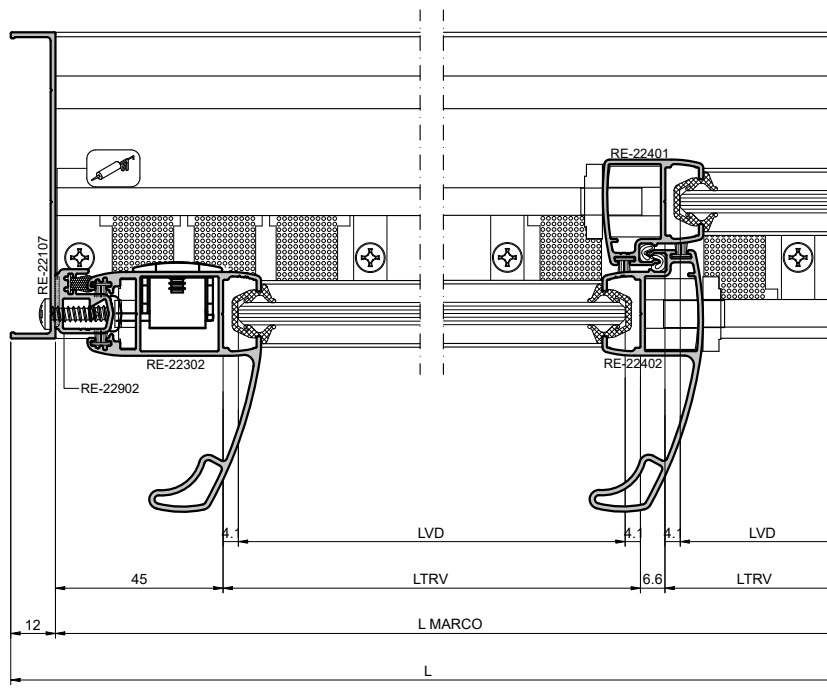

ESC.: 1:2

MONTAGENS COM 3 PLANOS COM MONTANTES LATERAL E CENTRAL COM OPÇÃO DE PERFIL COM REFORÇO

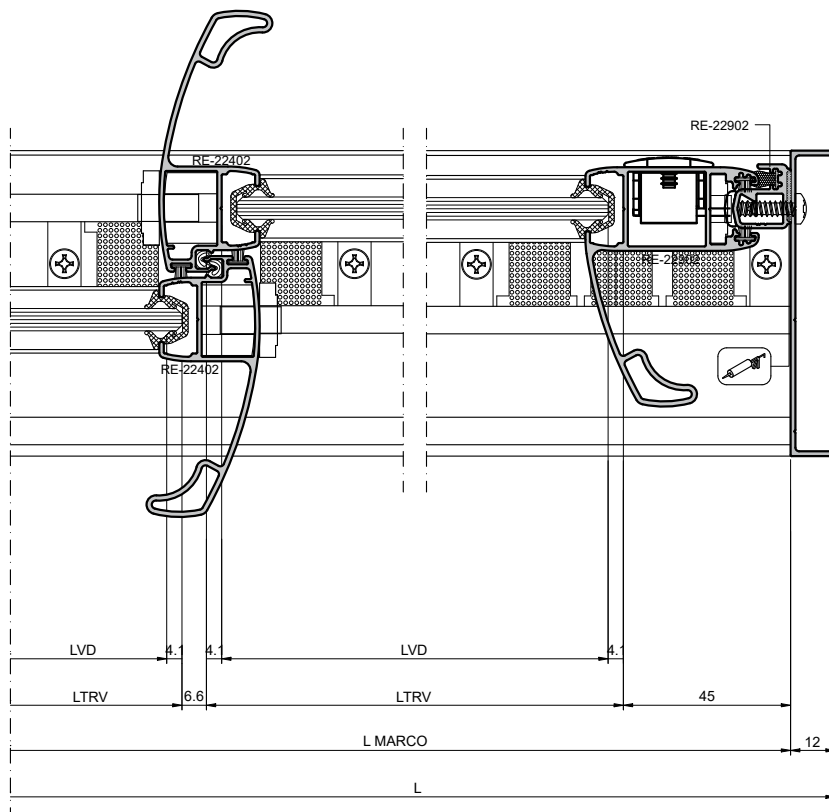
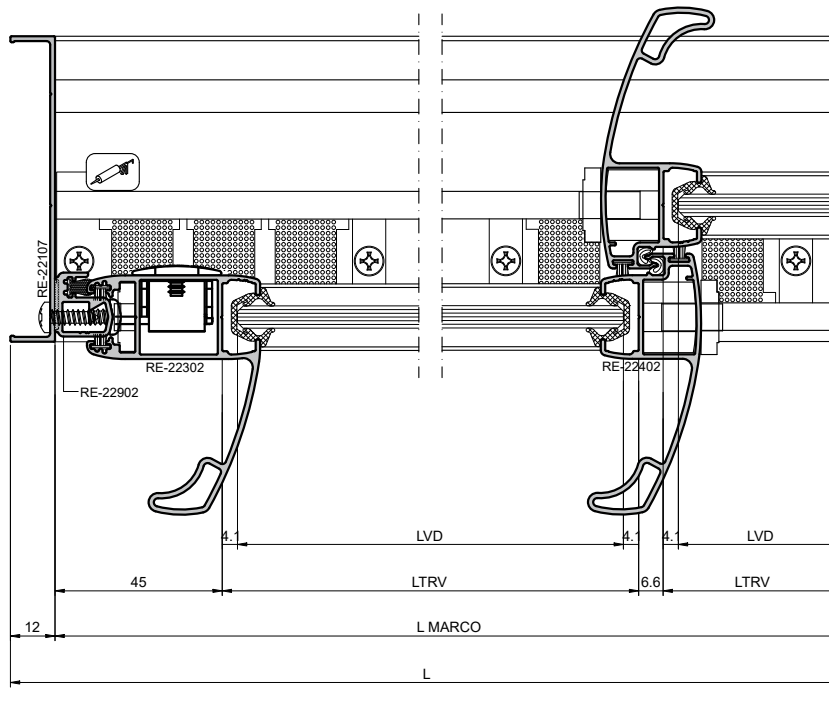

ESC.: 1:2

MONTAGENS COM 3 PLANOS COM MONTANTES LATERAL E CENTRAL COM OPÇÃO DE PERFIL COM REFORÇO

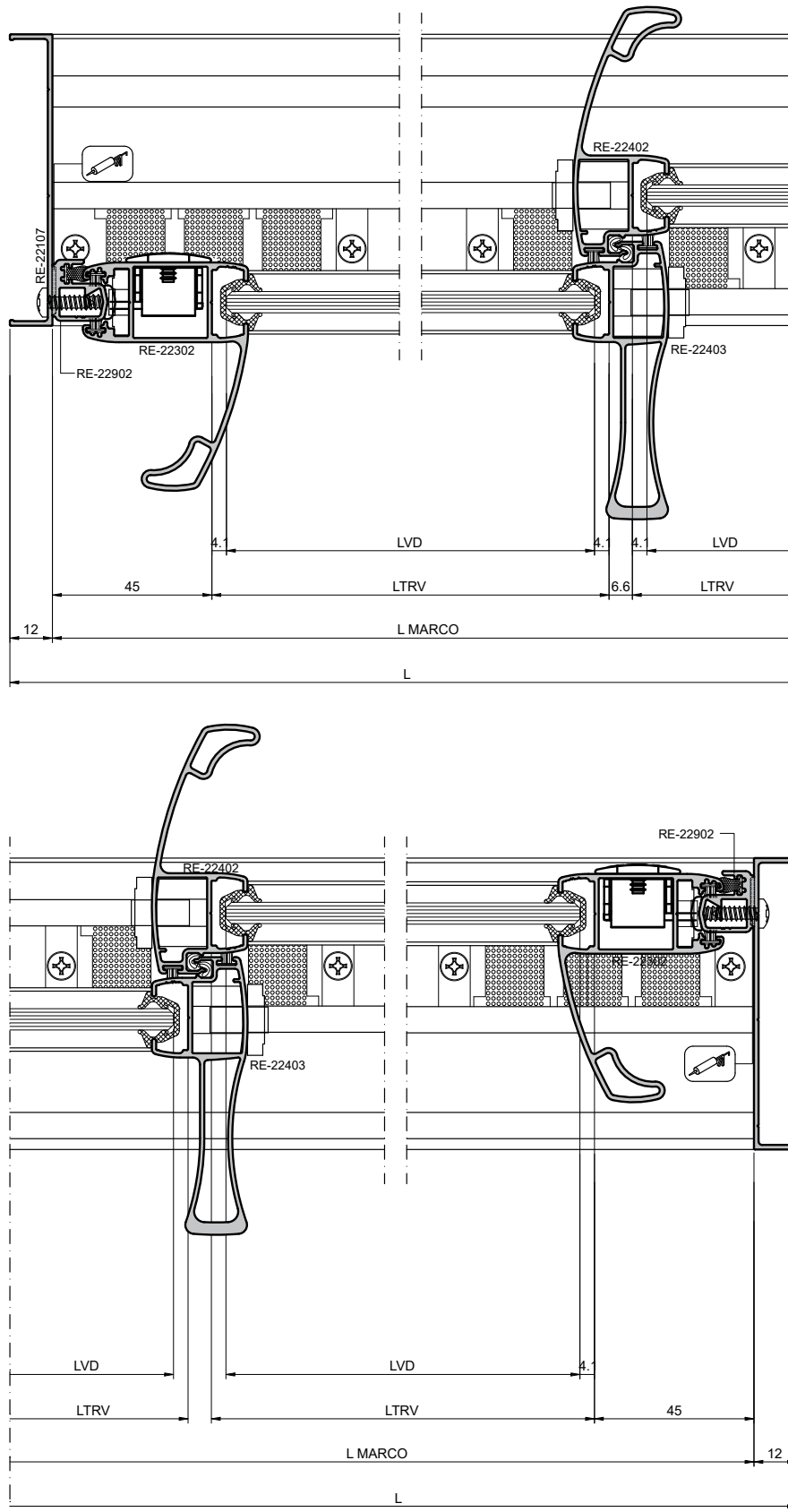

ESC.: 1:2

MONTAGENS COM 3 PLANOS COM MONTANTES LATERAL E CENTRAL COM OPÇÃO DE PERFIL COM REFORÇO

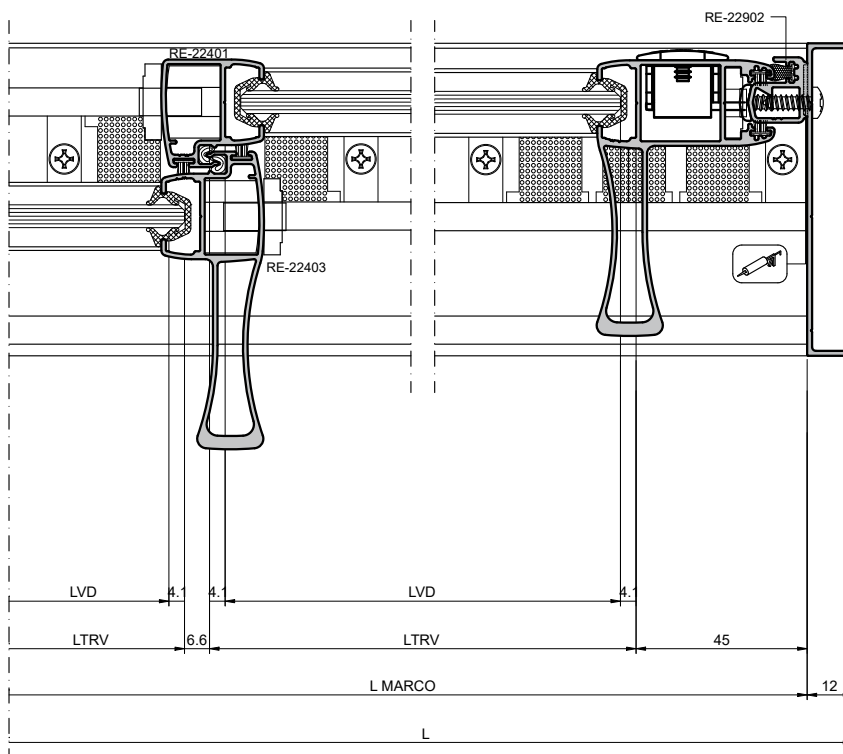
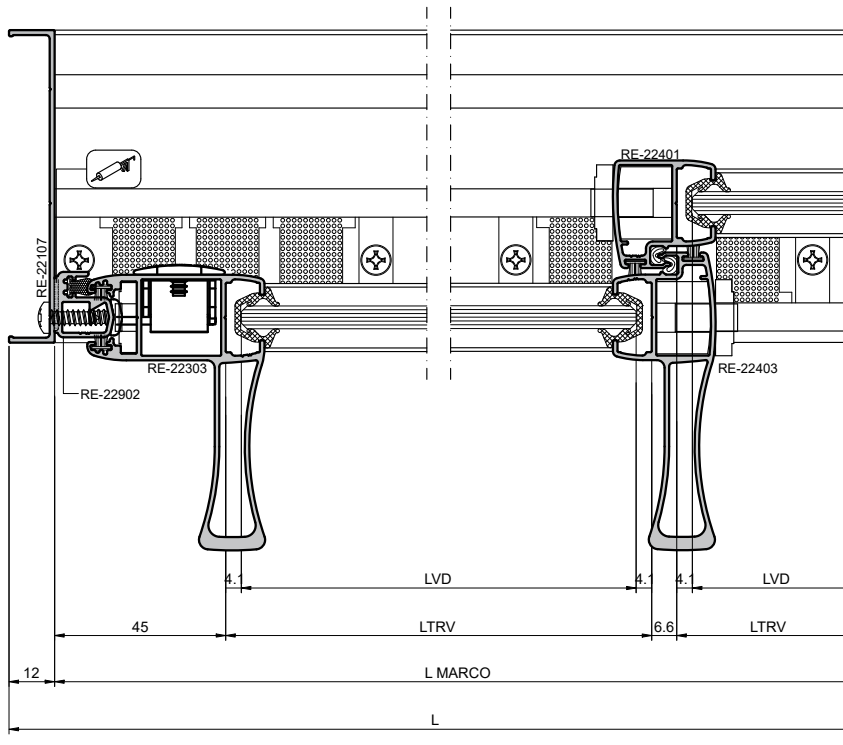

ESC.: 1:2

MONTAGENS COM 3 PLANOS COM MONTANTES LATERAL E CENTRAL COM OPÇÃO DE PERFIL COM REFORÇO

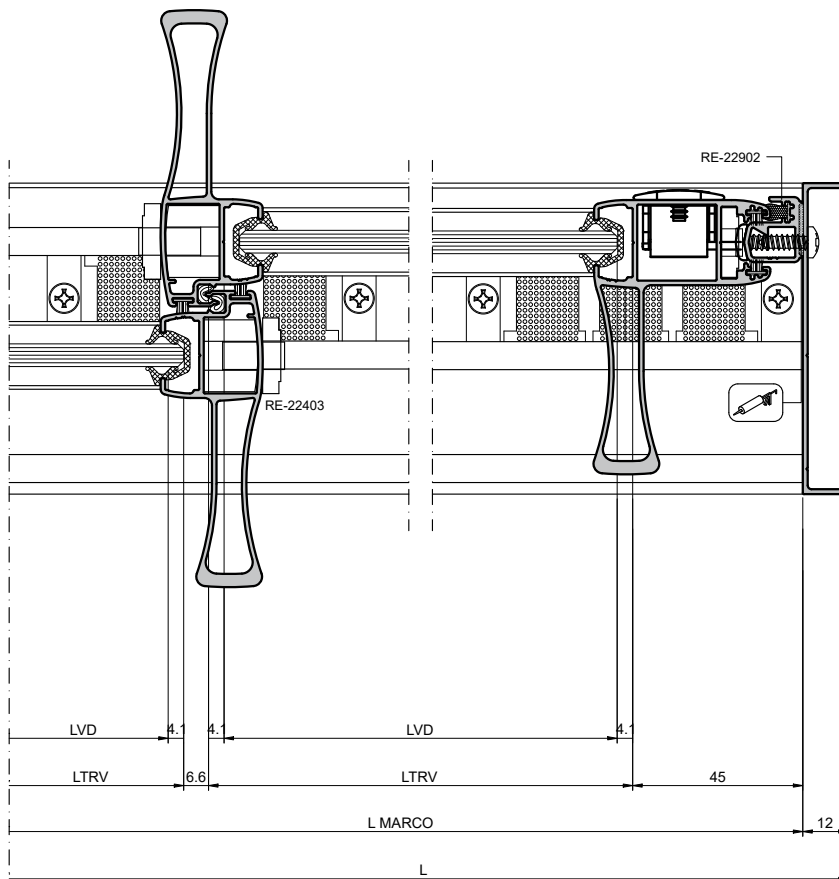
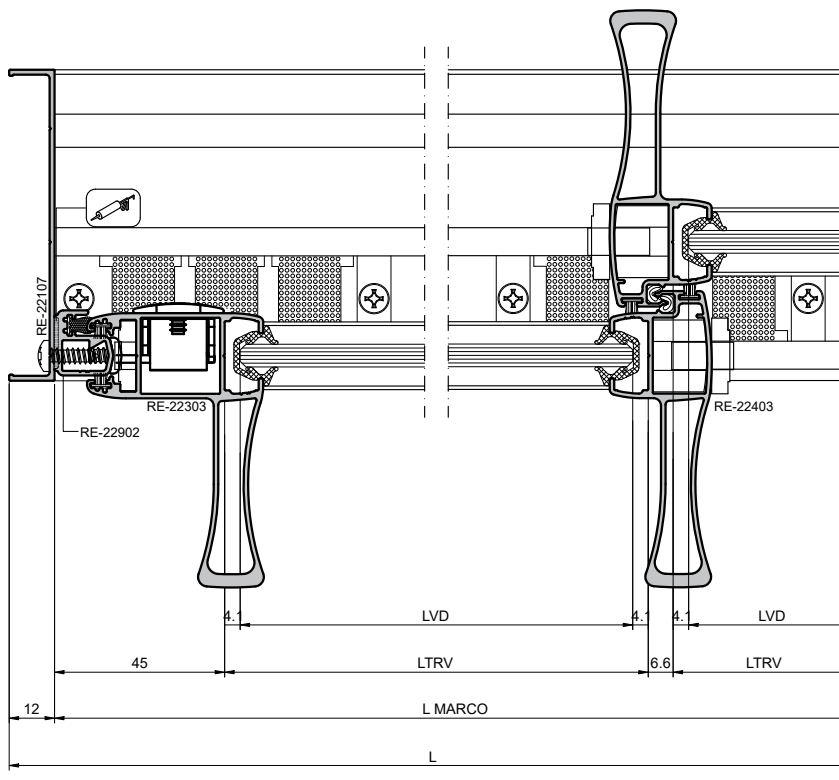

ESC.: 1:2

Montagem marco lateral e trilho superior

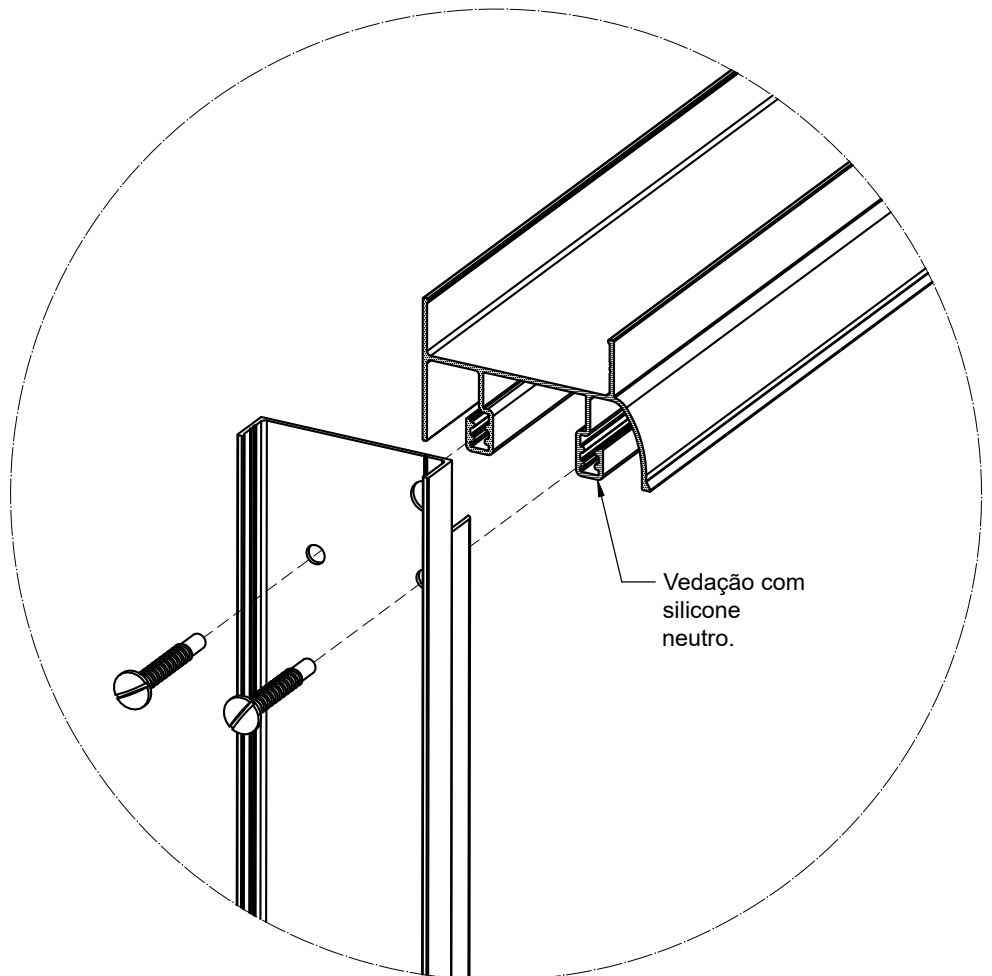
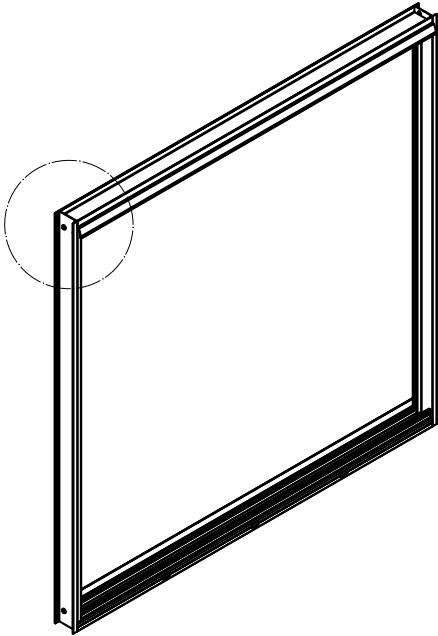

Montagem marco lateral e trilho inferior

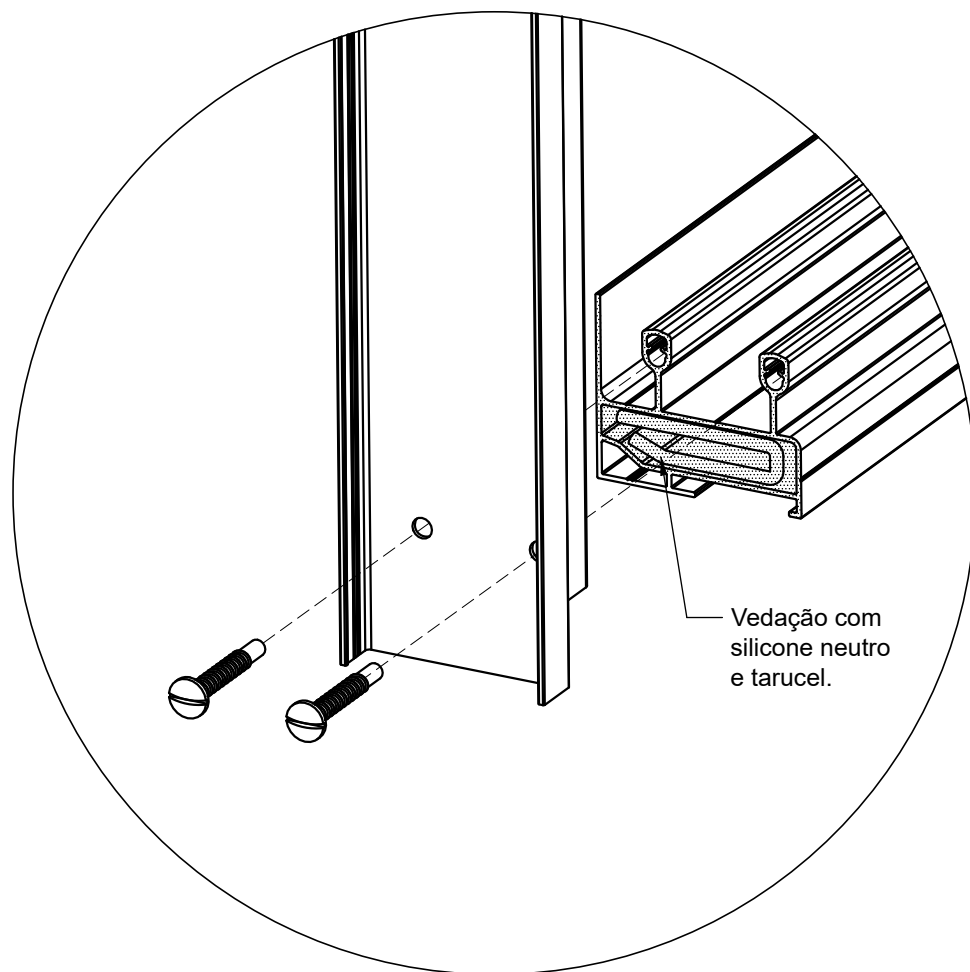
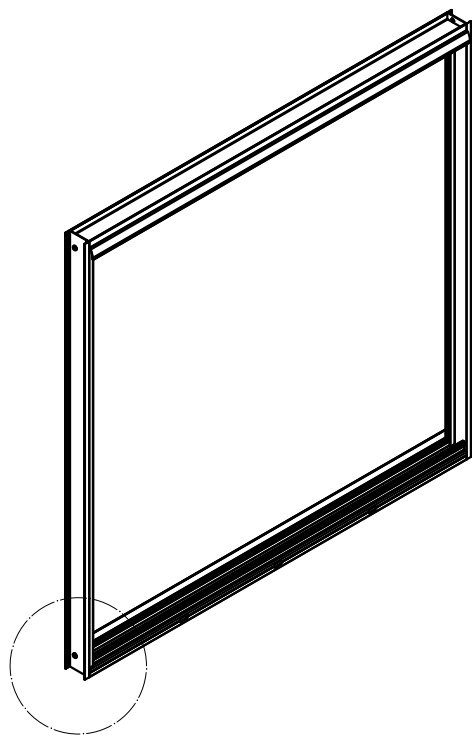

Montagem vedação central dos montantes

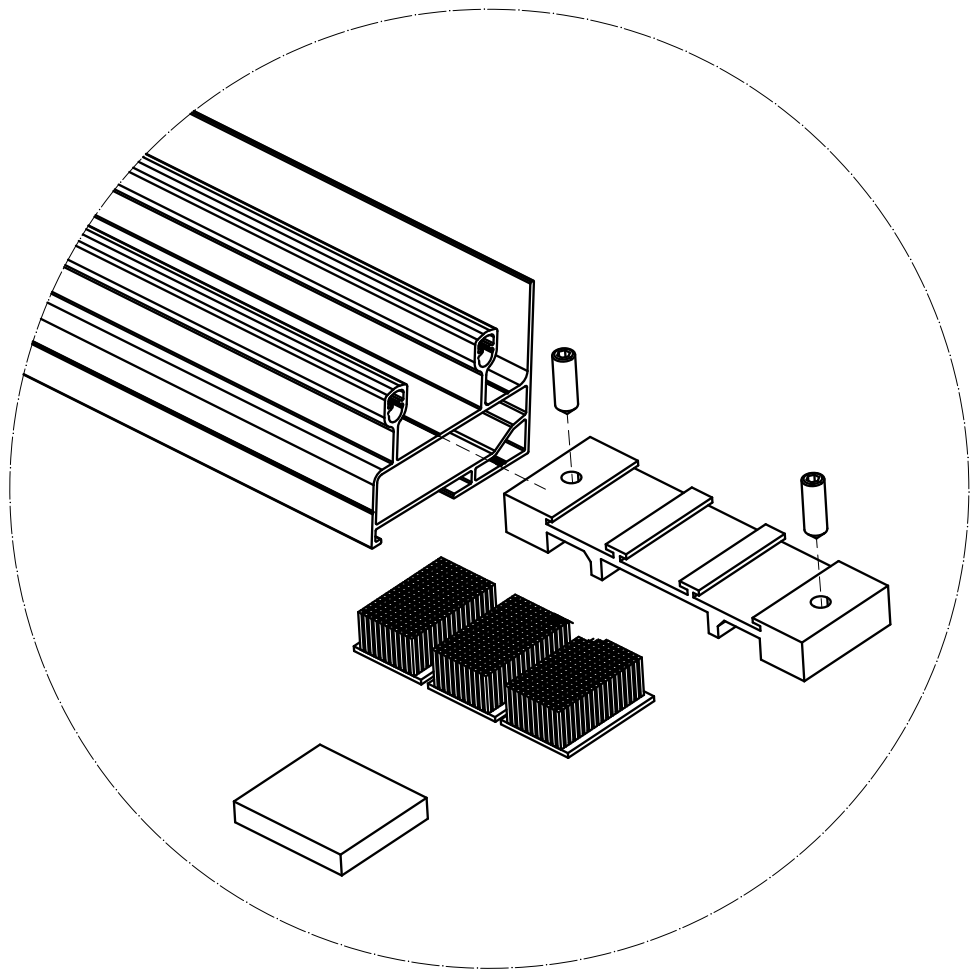
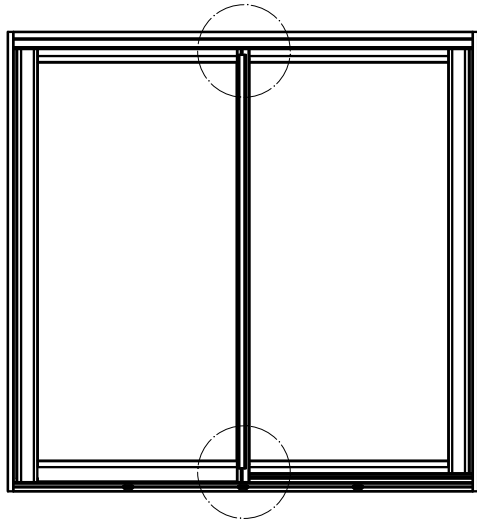

Montagem vedação lateral dos montantes

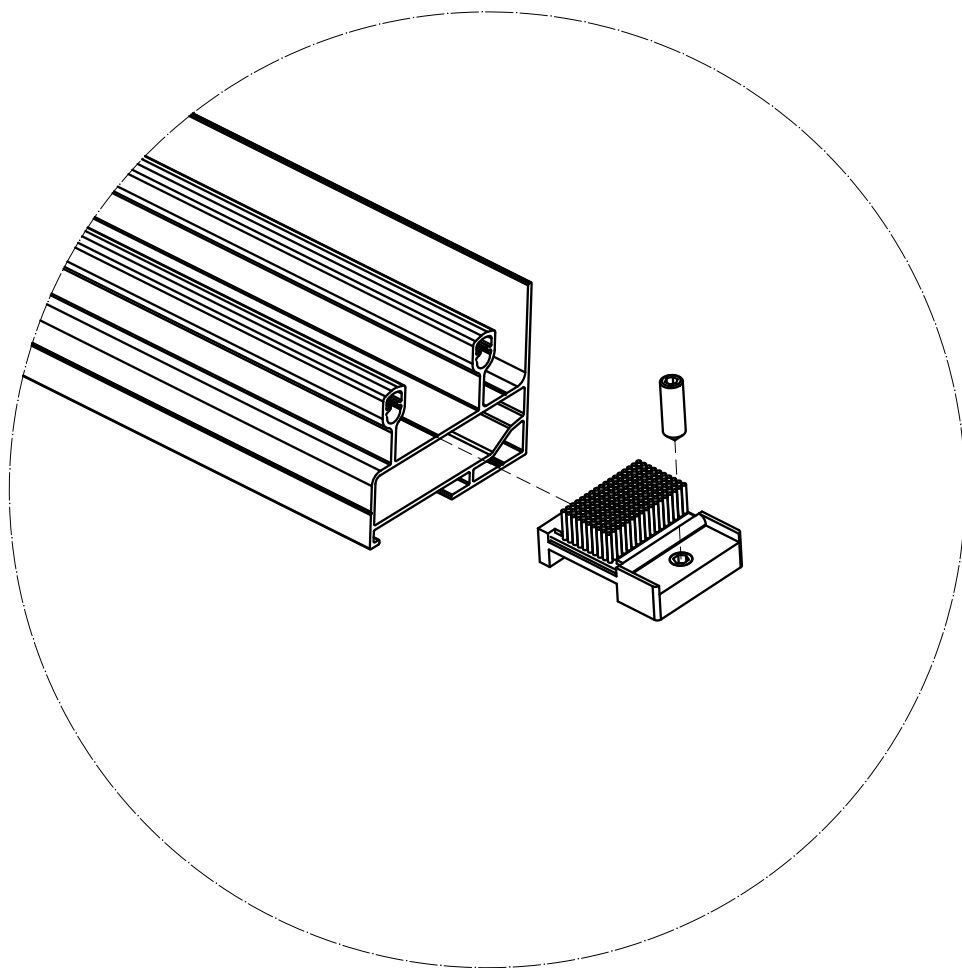
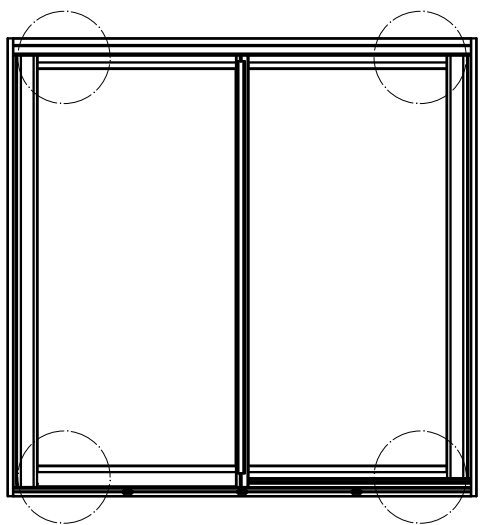

Montagem dreno

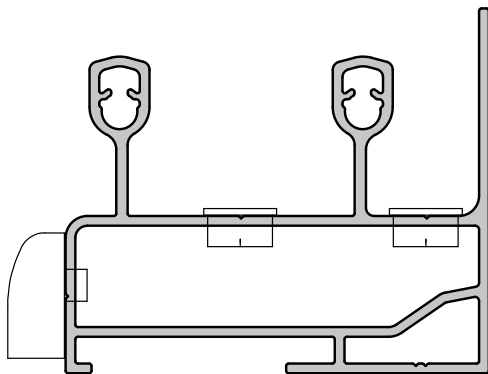
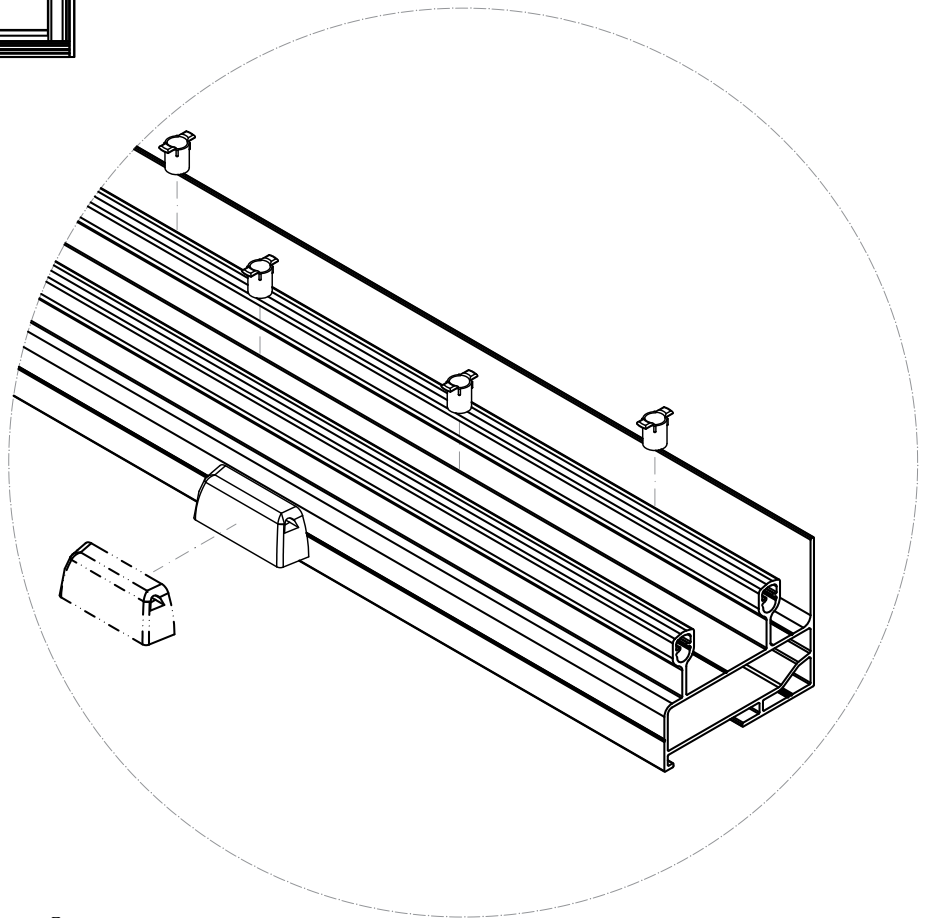
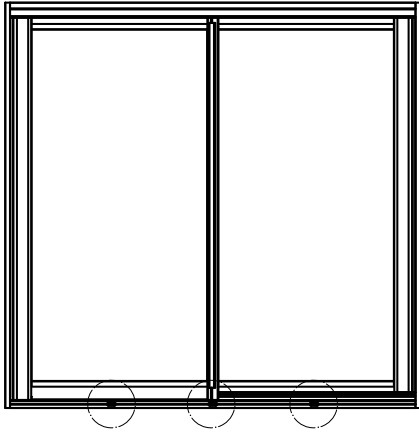

Montagem guia montante lateral

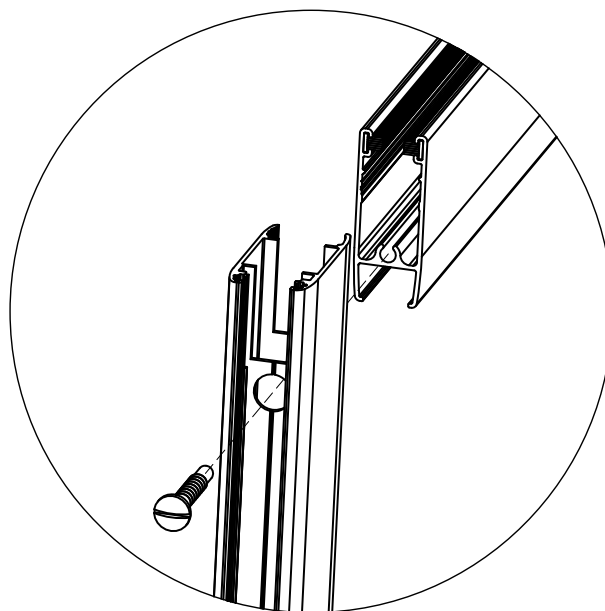
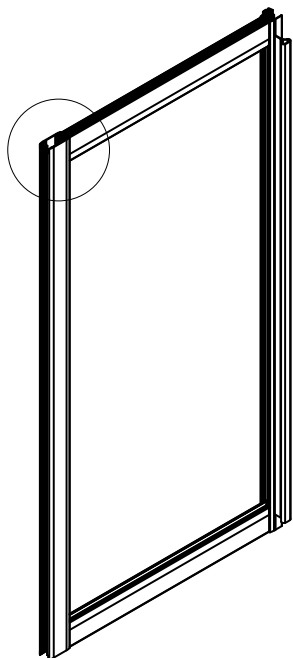

Montagem guia montante lateral

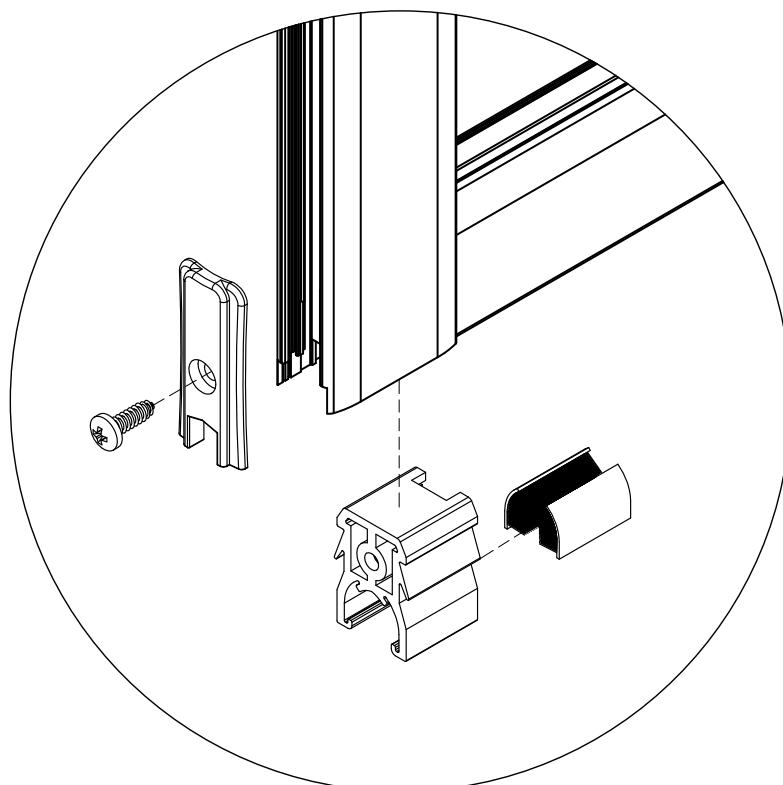
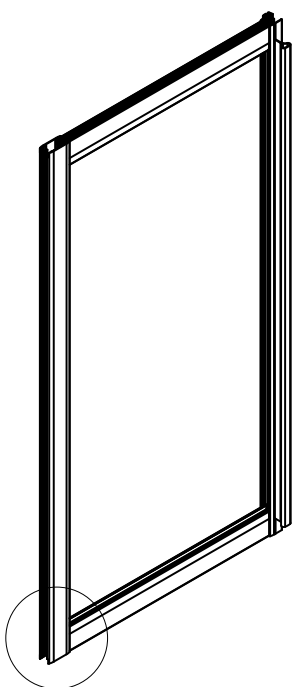

Montagem montante mão de amigo e travessa

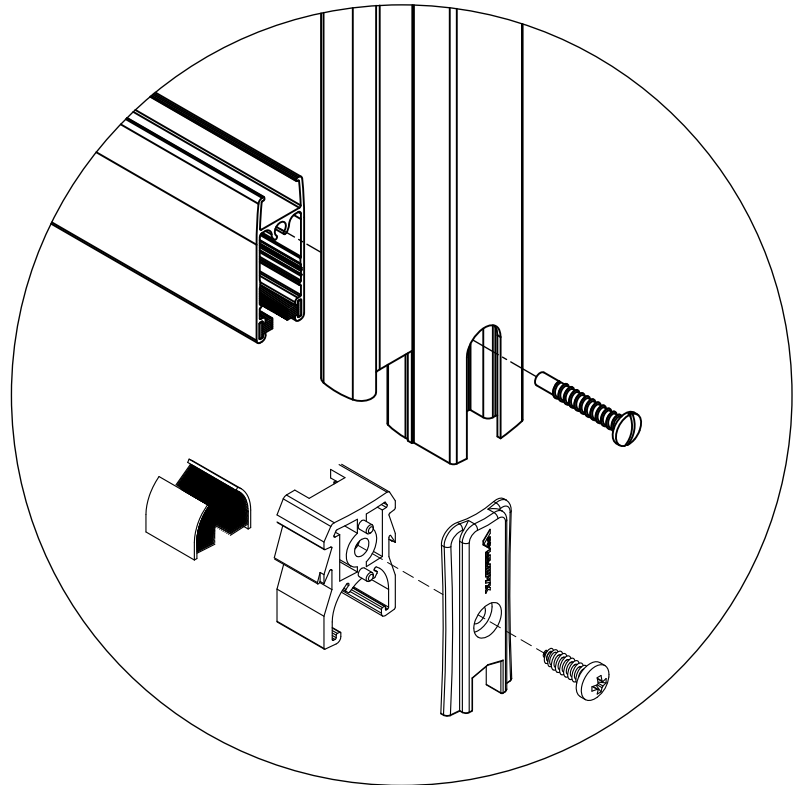
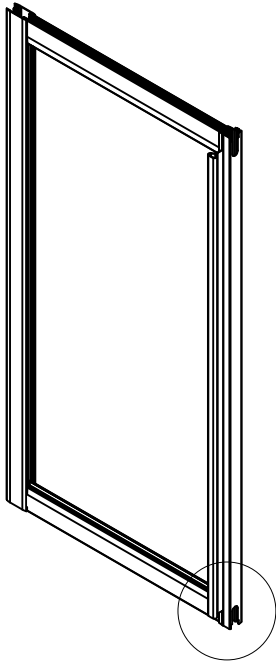

Montagem montante mão de amigo e travessa

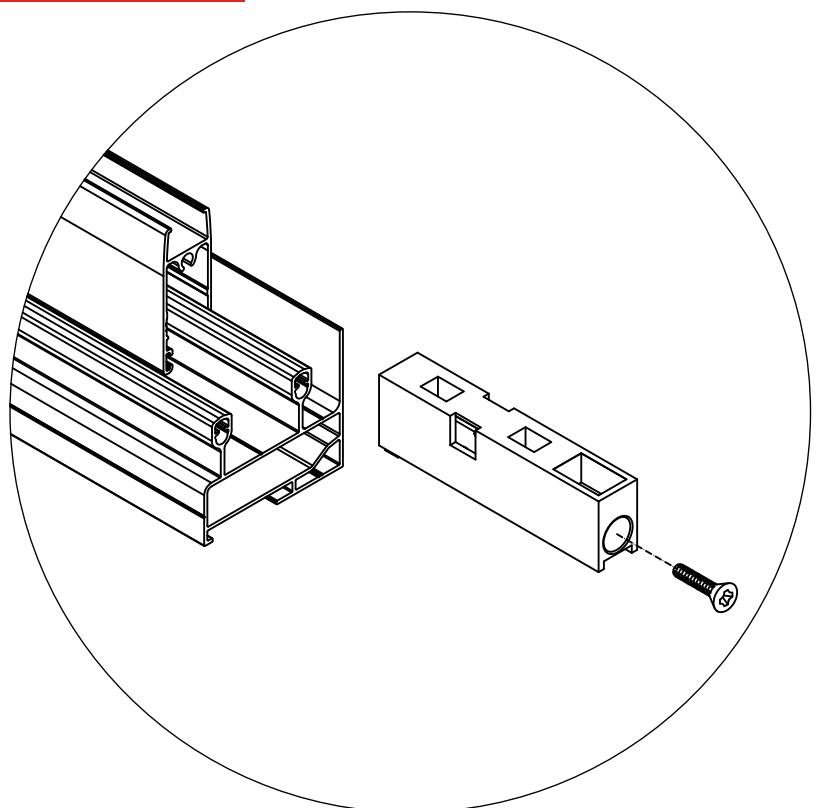
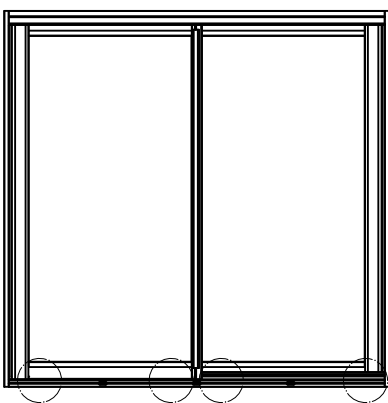

Montagem caixa integrada e marco lateral

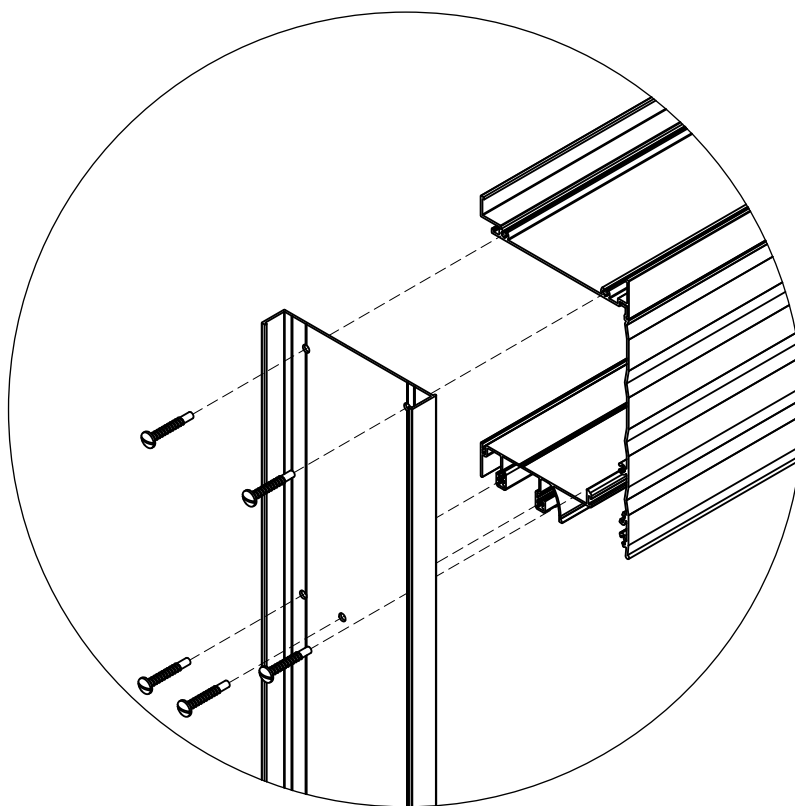

Montagem caixa integrada e tampa

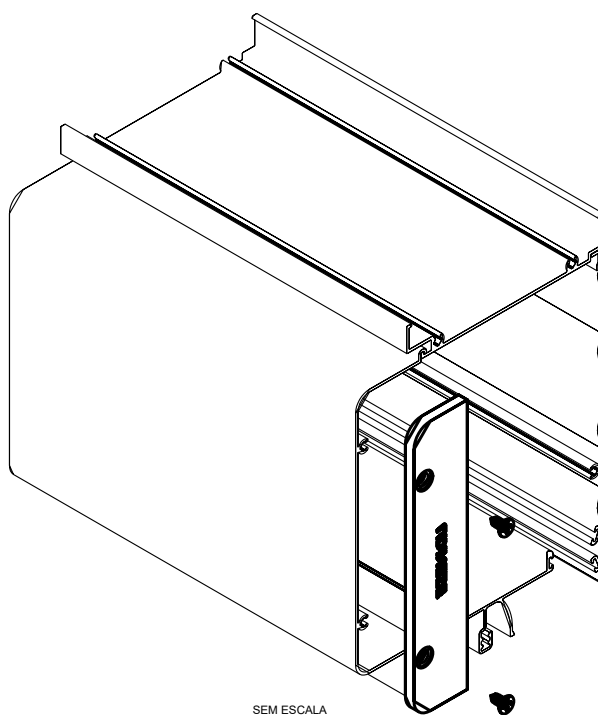

7

Usinagens

APLICAÇÕES

Perfil: **RE-22007**

USI 1

ESCALA 1:1

usinagem marco lateral 2 planos

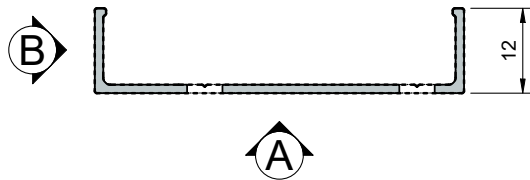
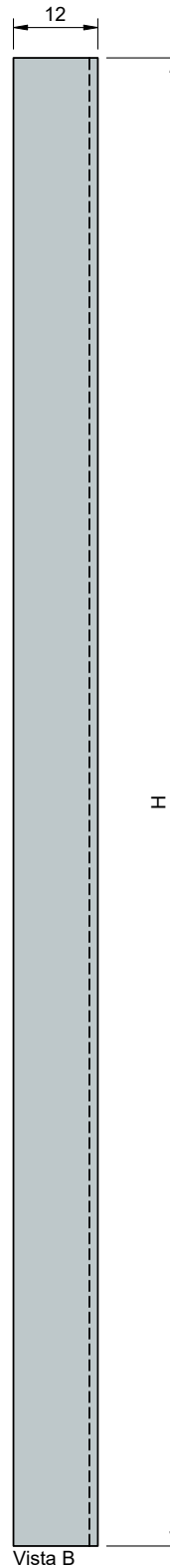
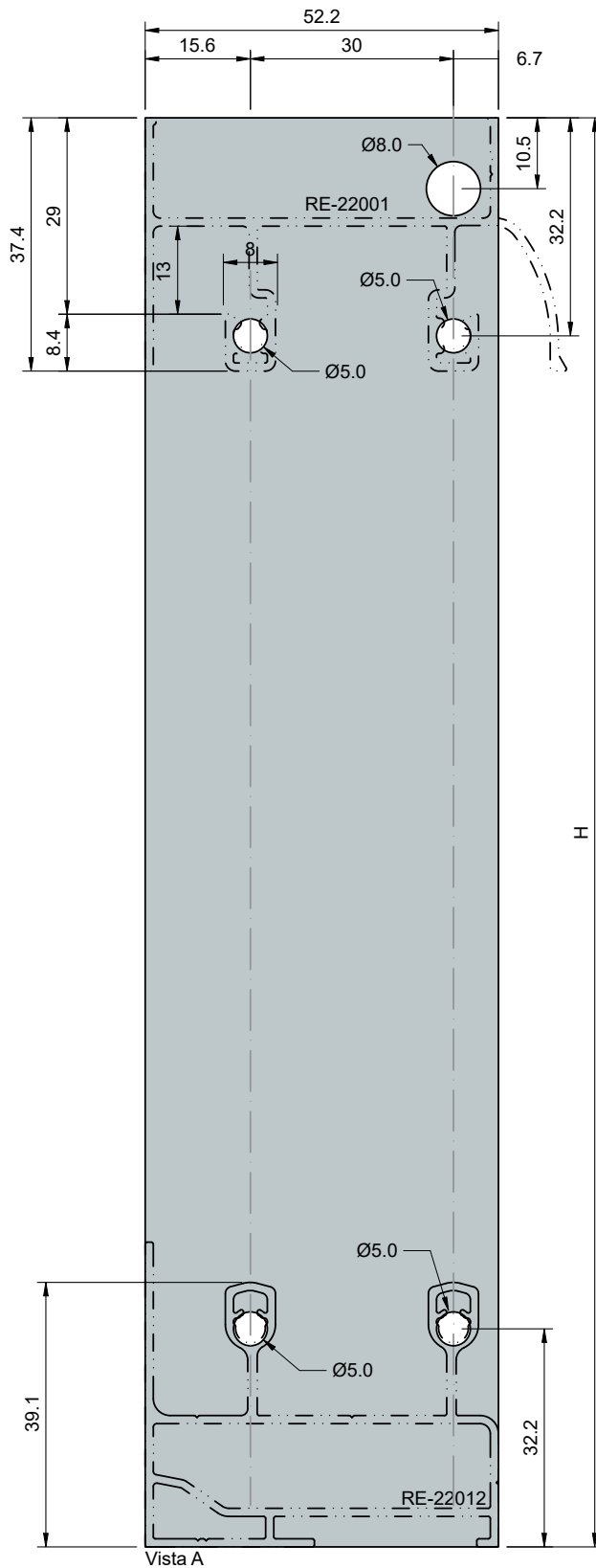
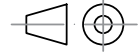

RE-22003

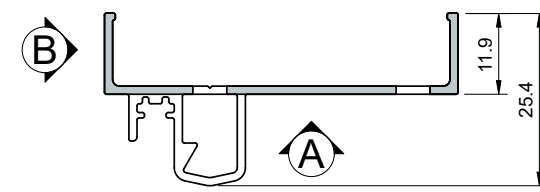
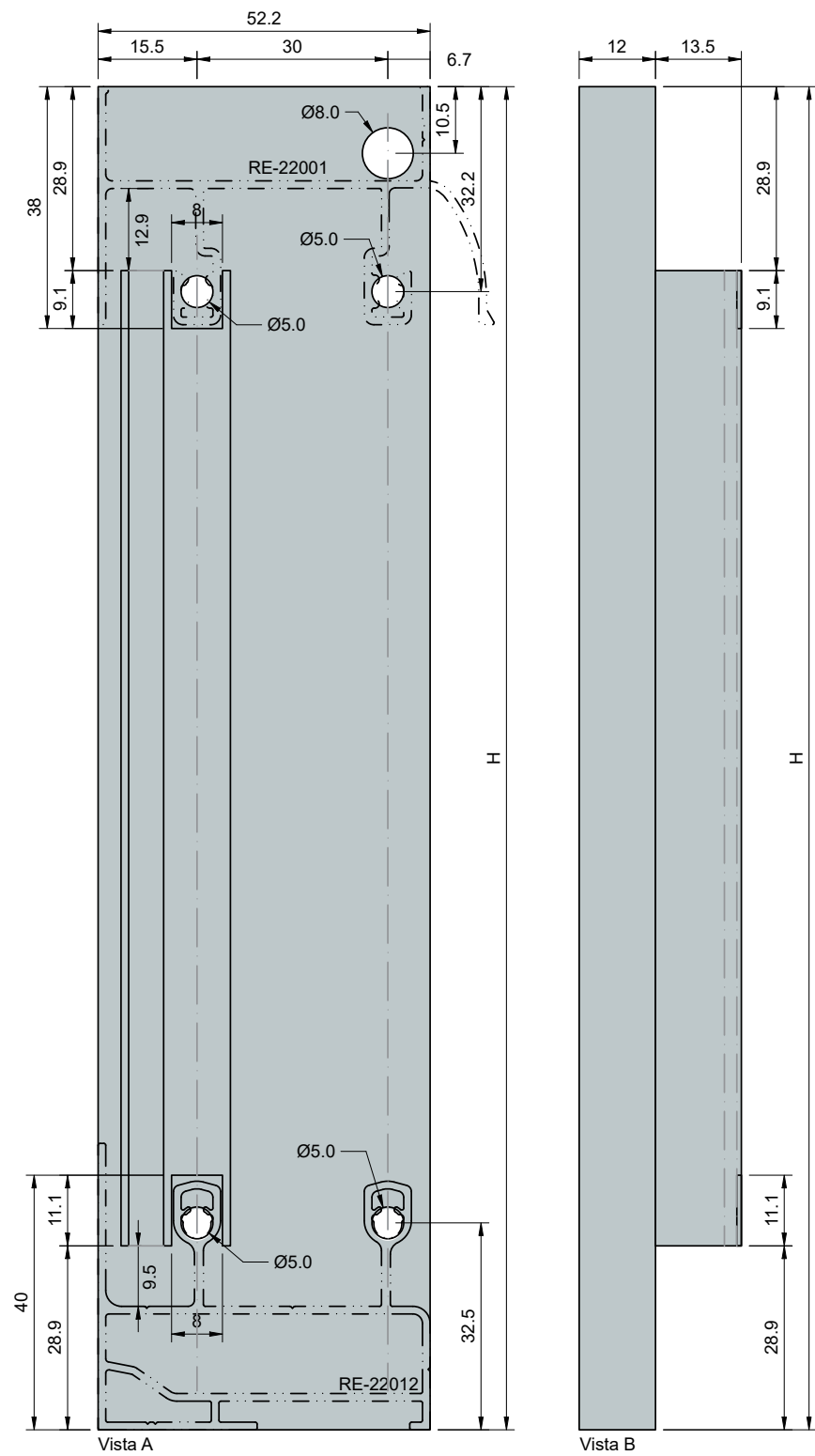

RE-22004

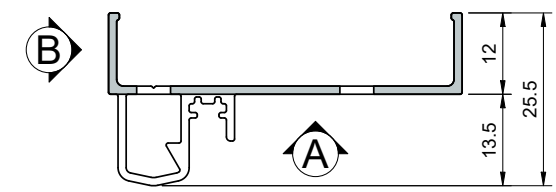
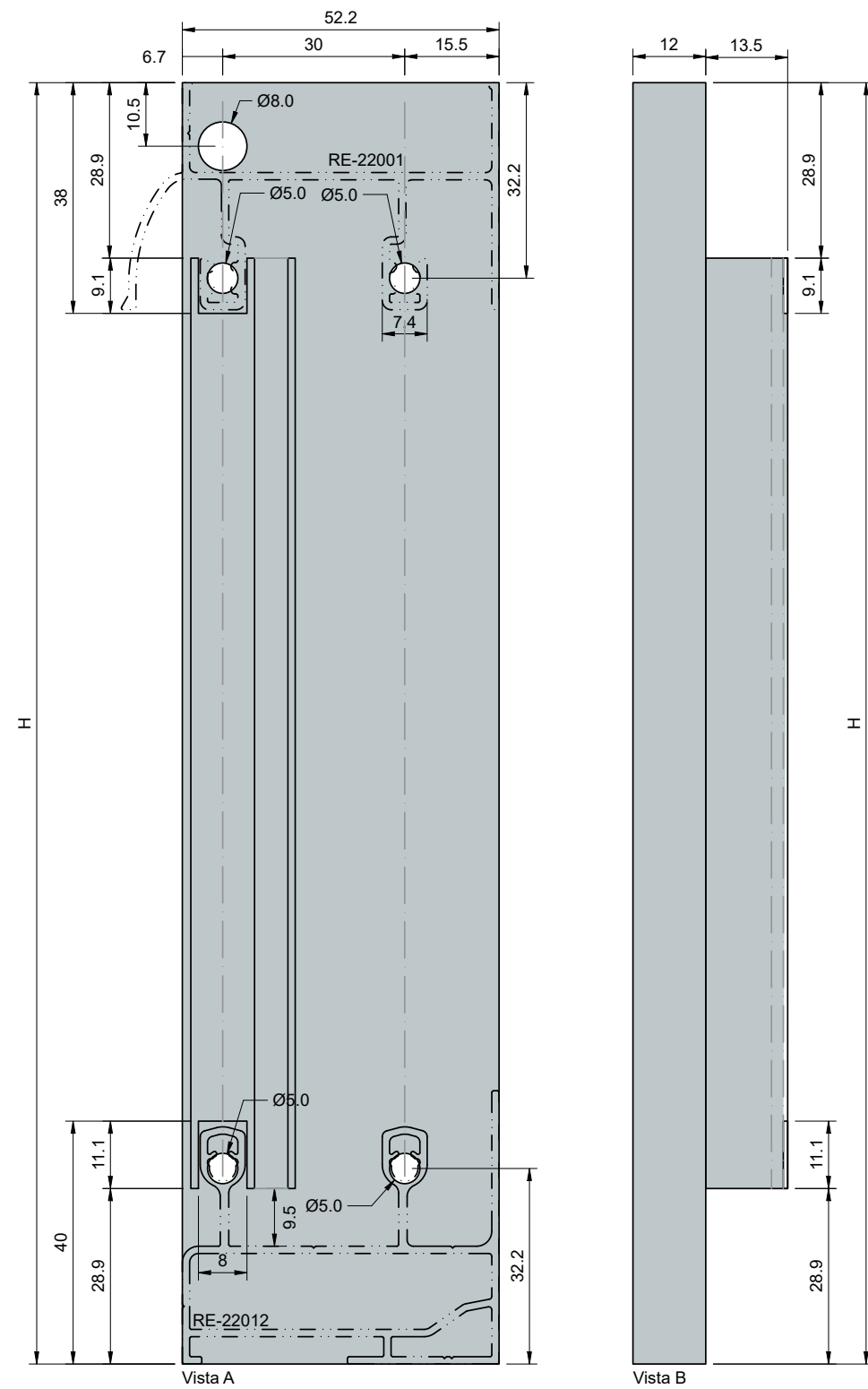

Perfil: **USI 2** RE-22004
RE-22003

ESCALA 1:1
usinagem marco lateral 2 planos

Perfil:

RE-22103

USI 3

ESCALA 1:1

usinagem marco lateral 3 planos

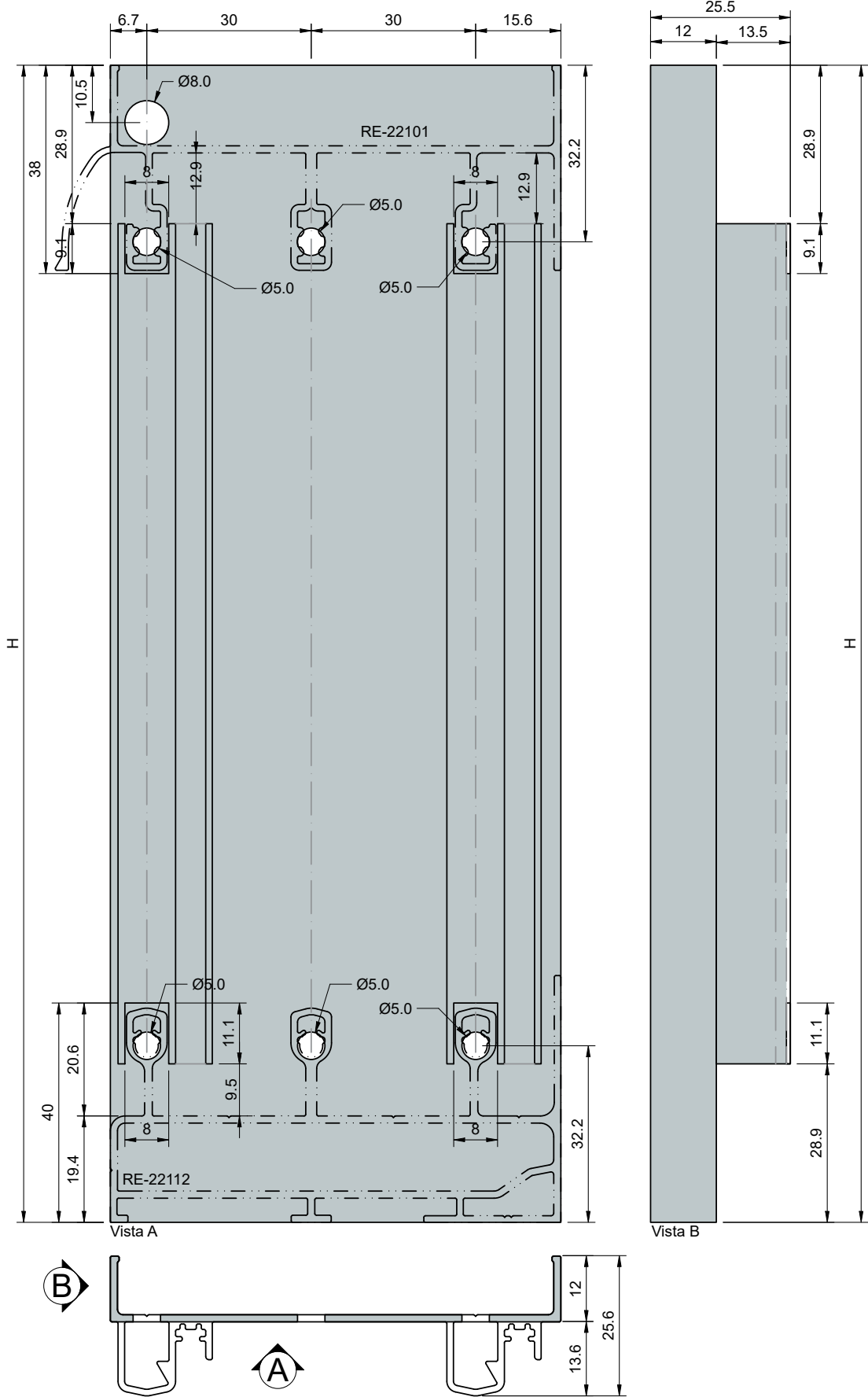

Perfil:

RE-22104

USI 4

ESCALA 1:1

usinagem marco lateral 3 planos

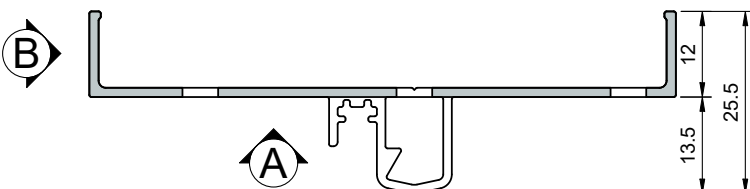
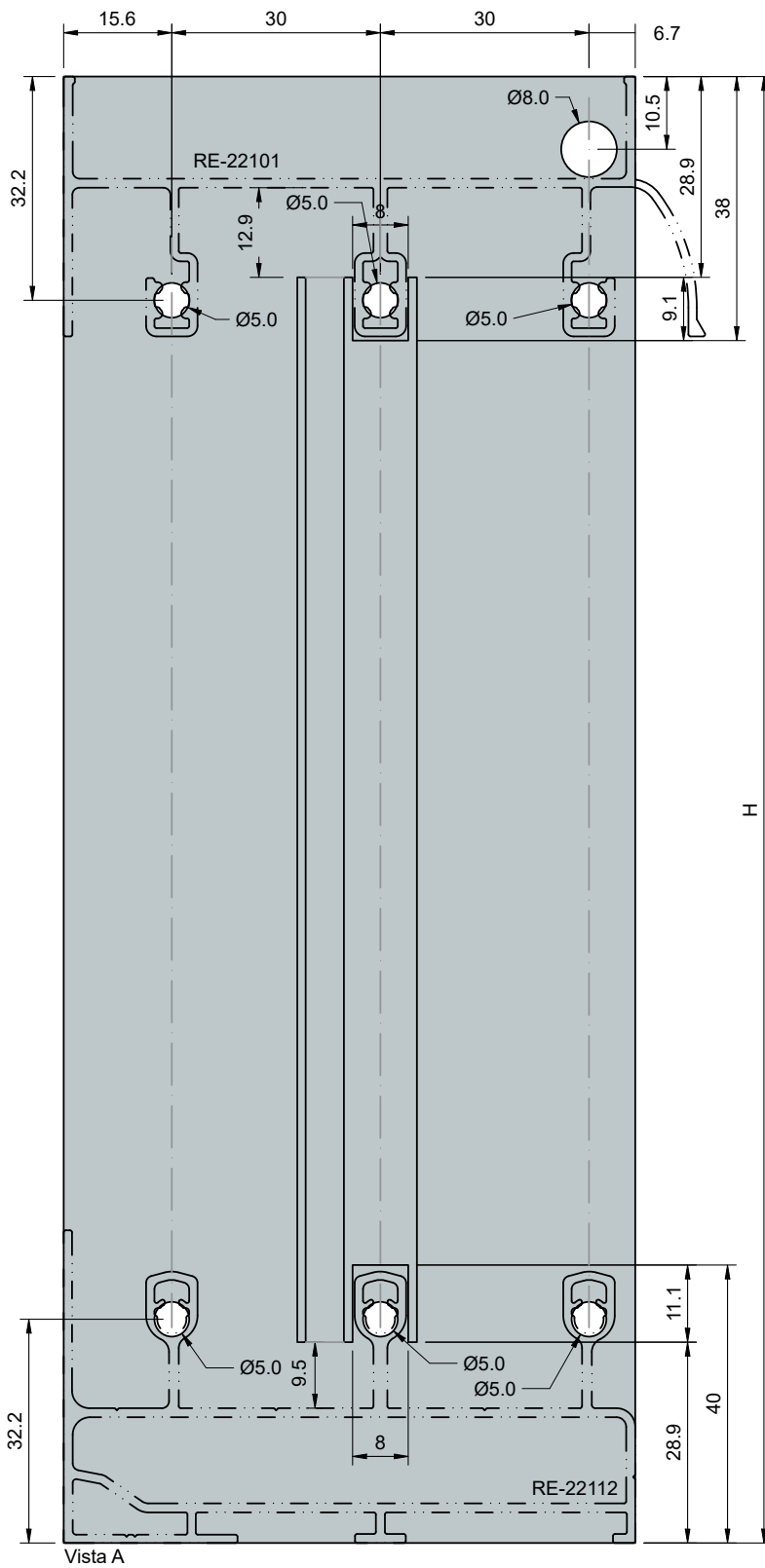

Perfil:

RE-22104

USI 4

ESCALA 1:1

usinagem marco lateral 3 planos

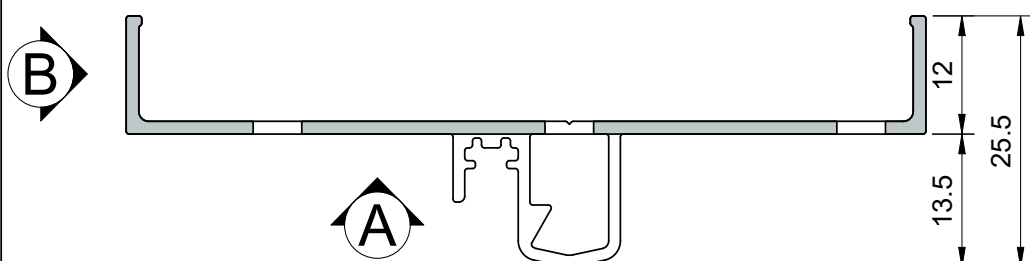
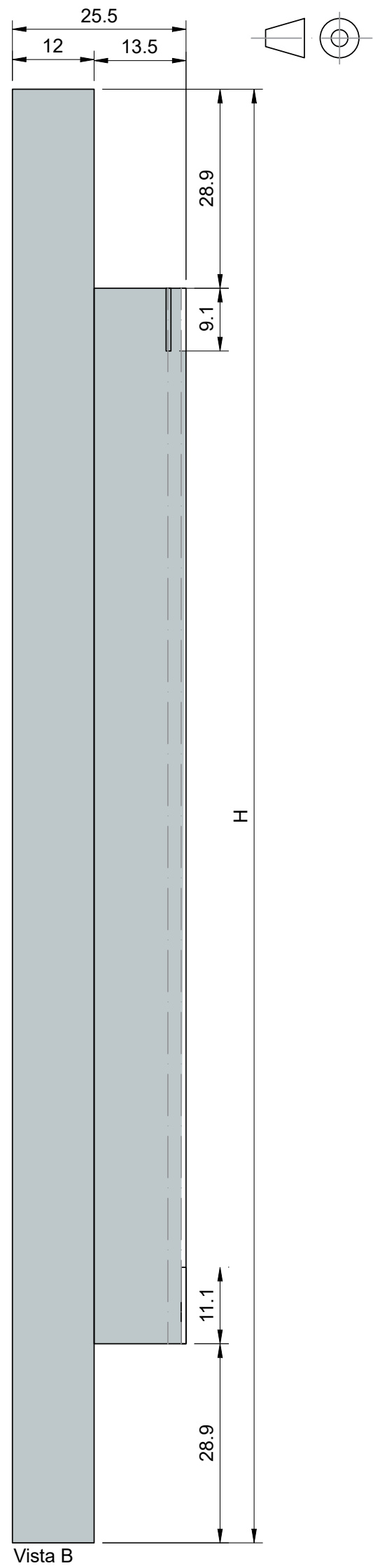
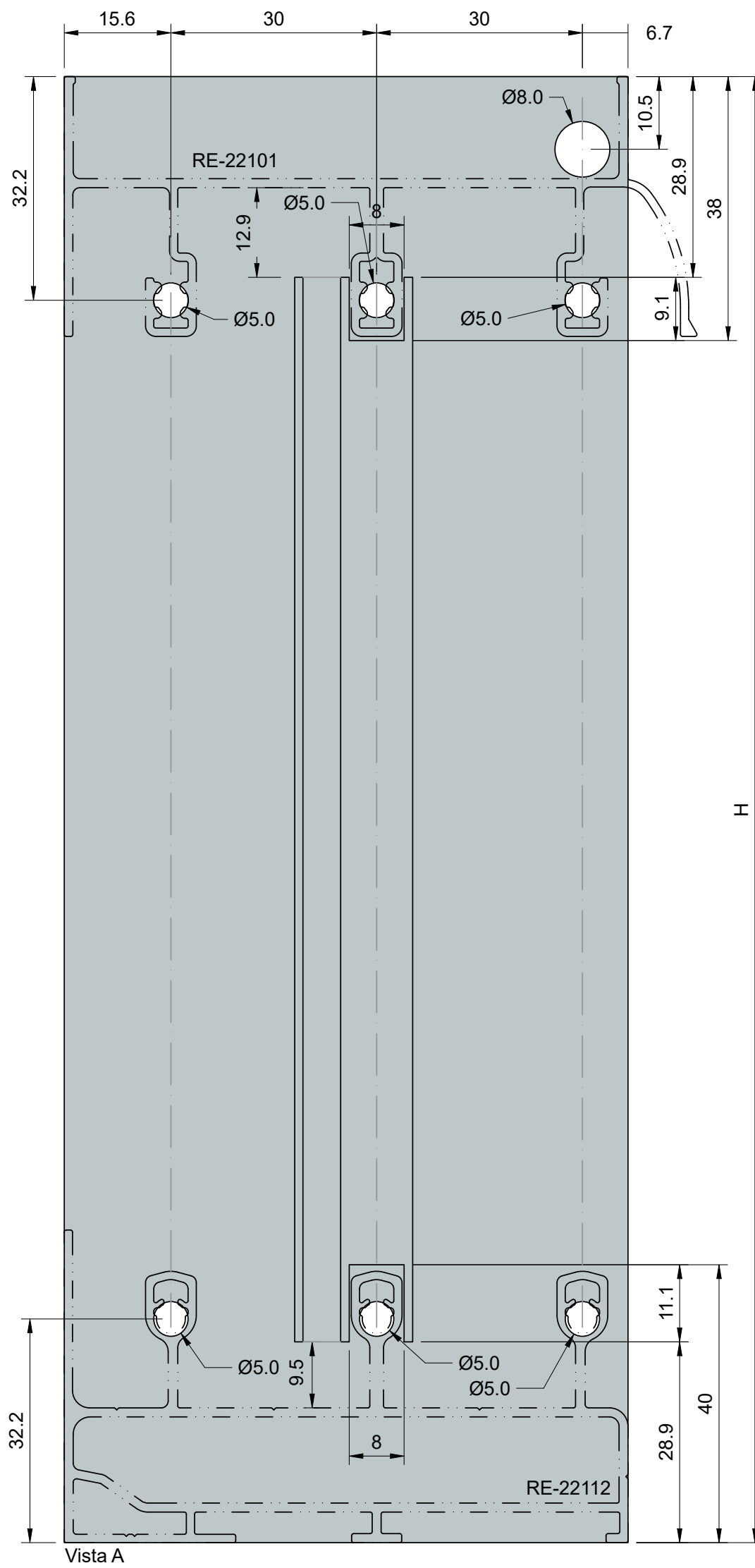

Perfil: **RE-22107**
USI 6

ESCALA 1:1
 usinagem marco lateral 3 planos

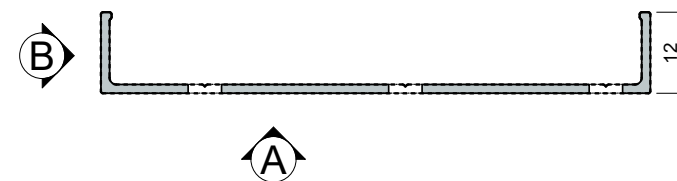
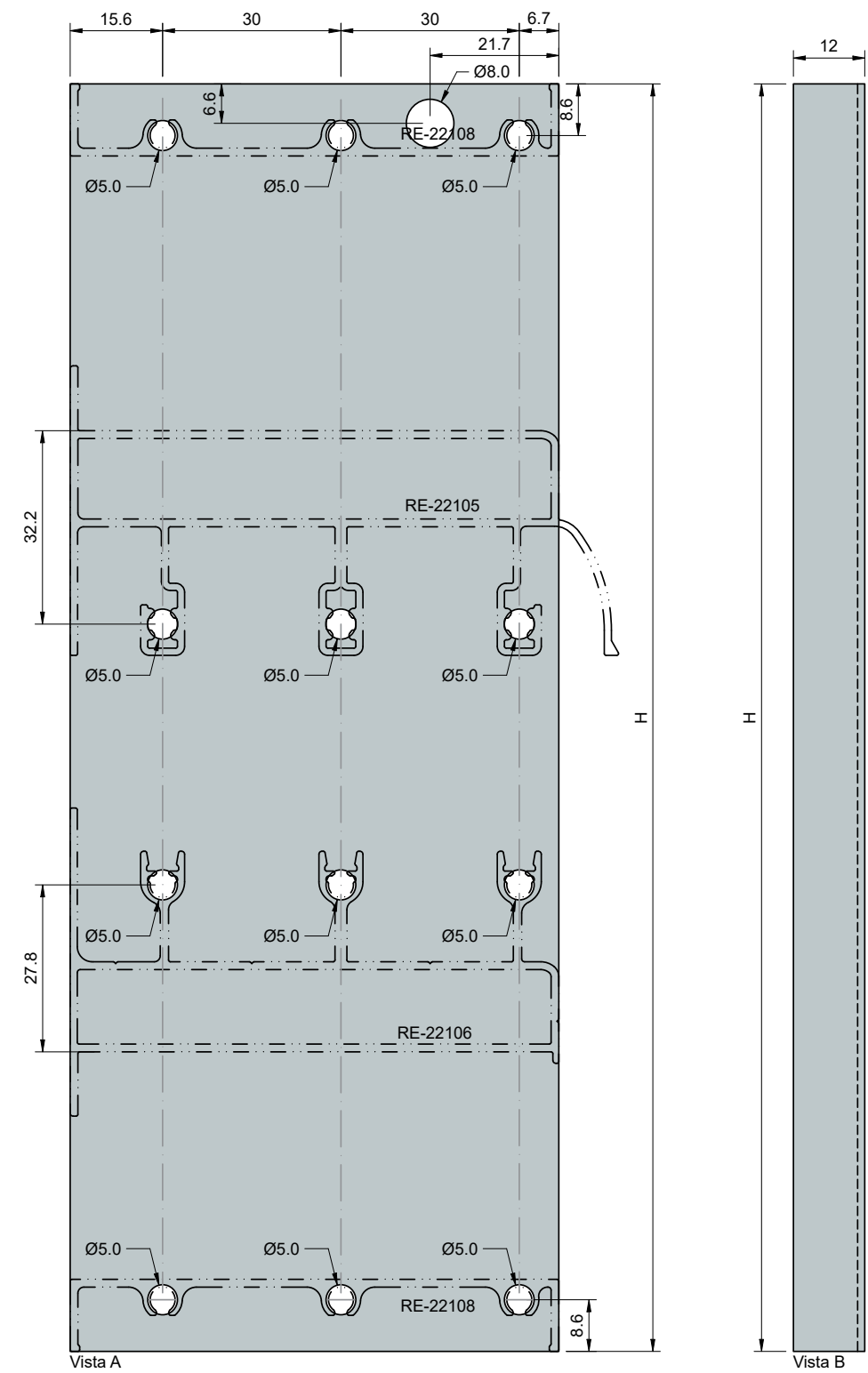
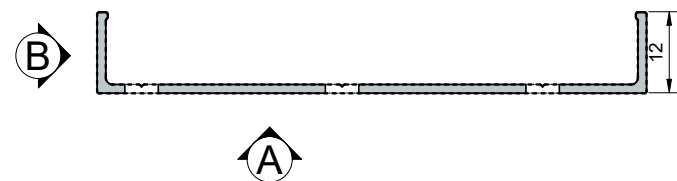
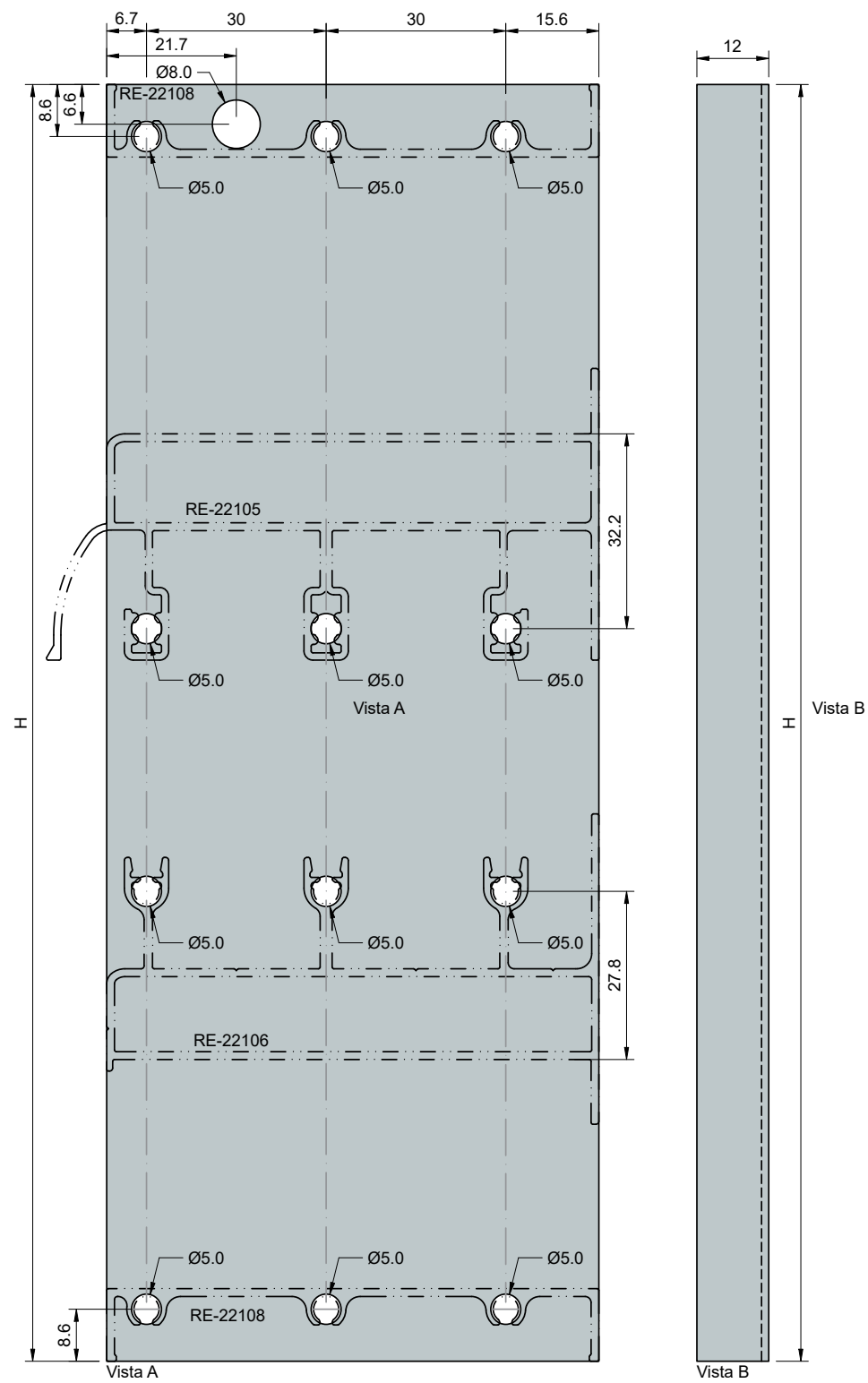
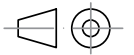

Perfil: **RE-22107**
USI 7

ESCALA 1:1
usinagem marco lateral 3 planos

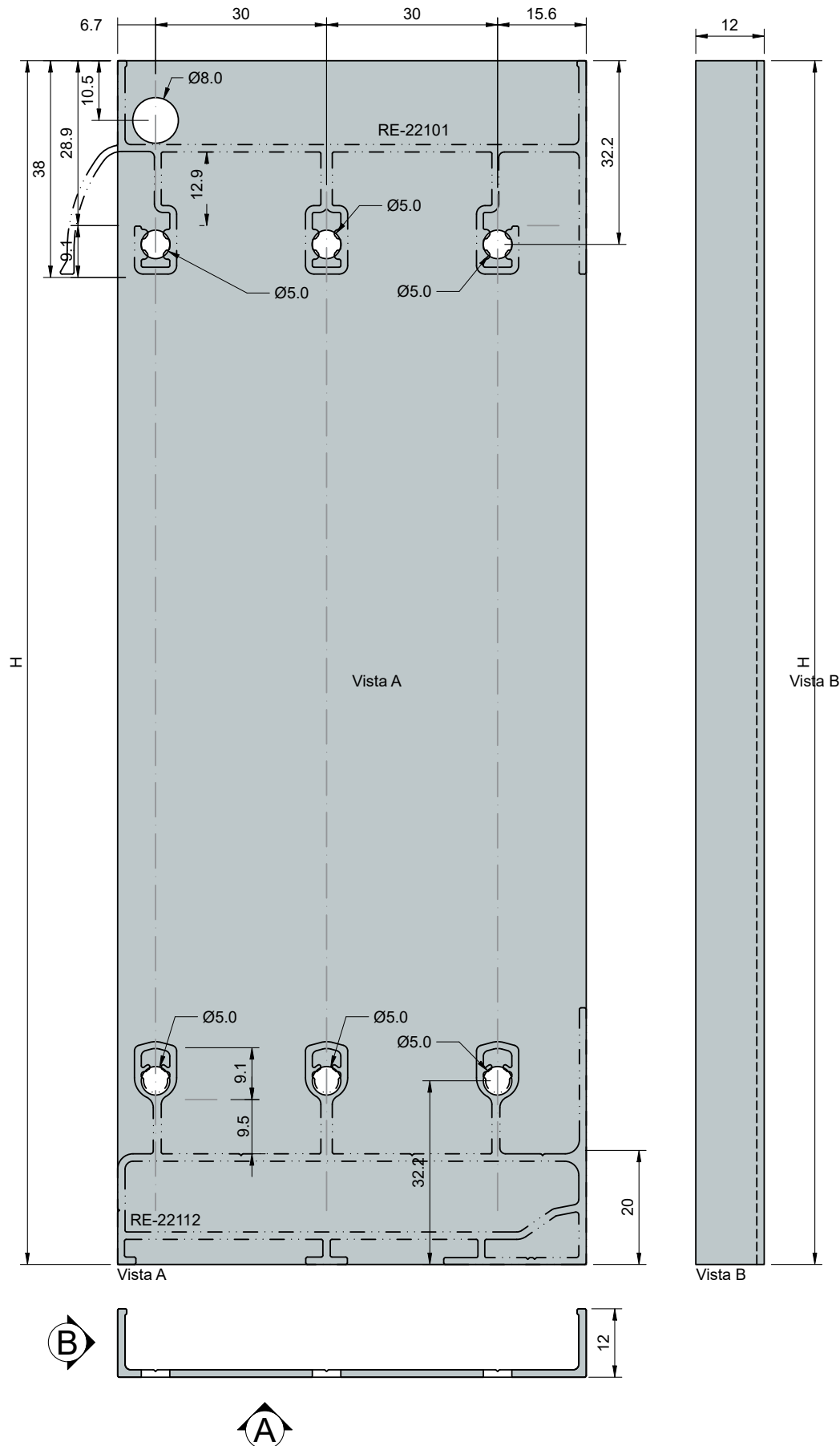
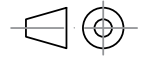

Perfil:

USI 8

RE-22902

ESCALA 1:1
usinagem marco lateral mata junta

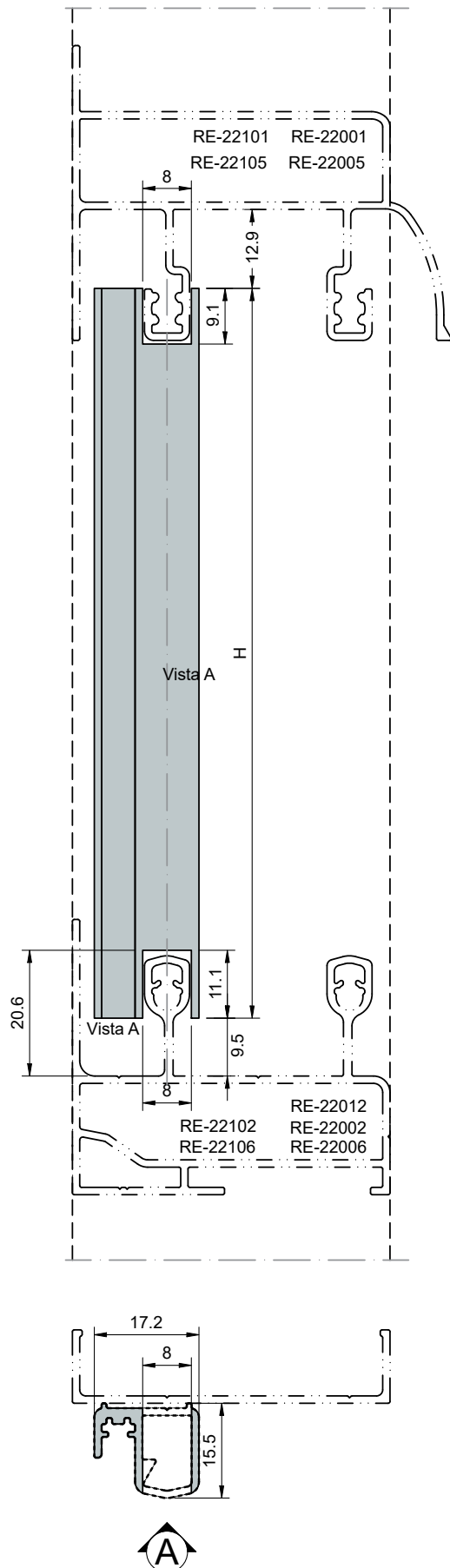
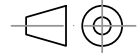

Perfil: RE-22903

USI 9

ESCALA 1:1

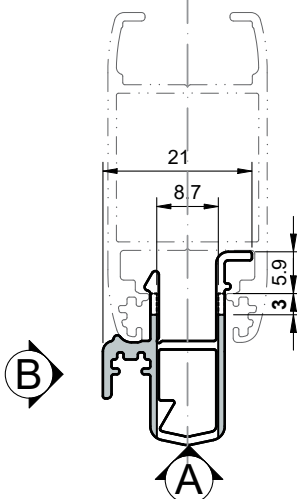
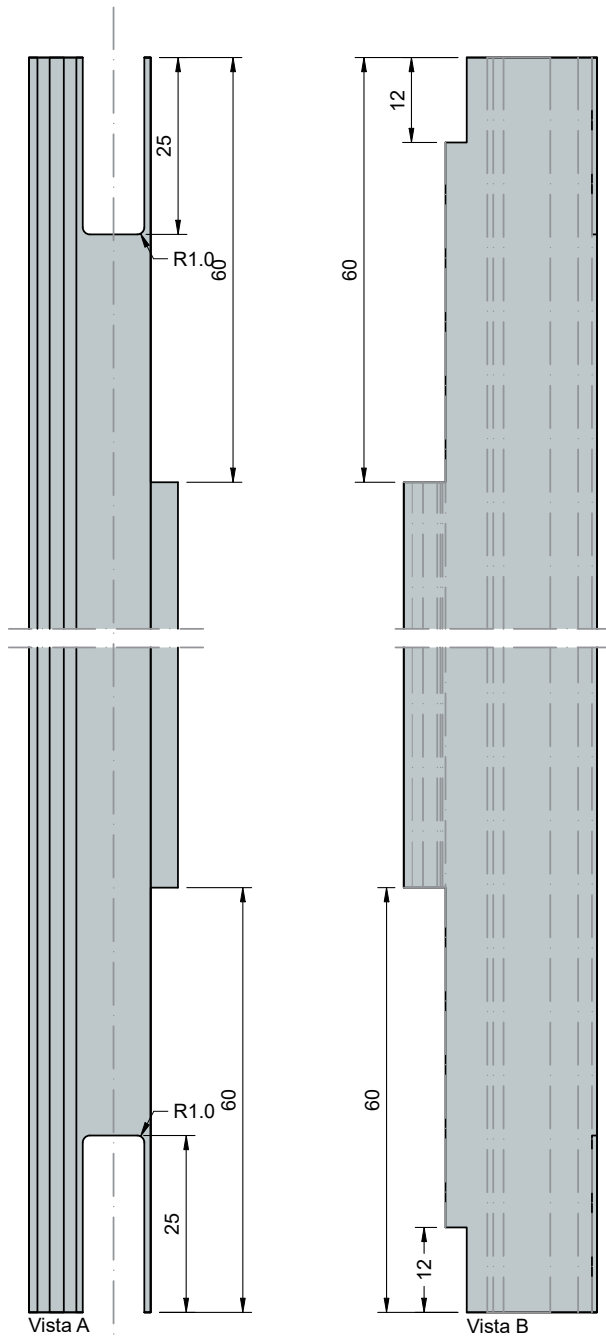
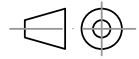

Perfil: **RE-22012**
USI 11.C

ESCALA 1:5
usinagem trilho 02 planos para janela 02 folhas

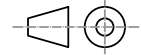

Perfil: **RE-22012**

USI 11.D

ESCALA 1:2

usinagem trilho 02 planos para janela 02 folhas

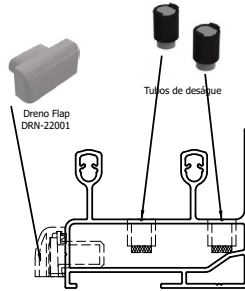
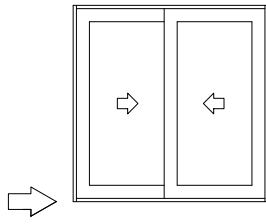
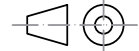

Representação dos Drenos e Tubos de deságue .

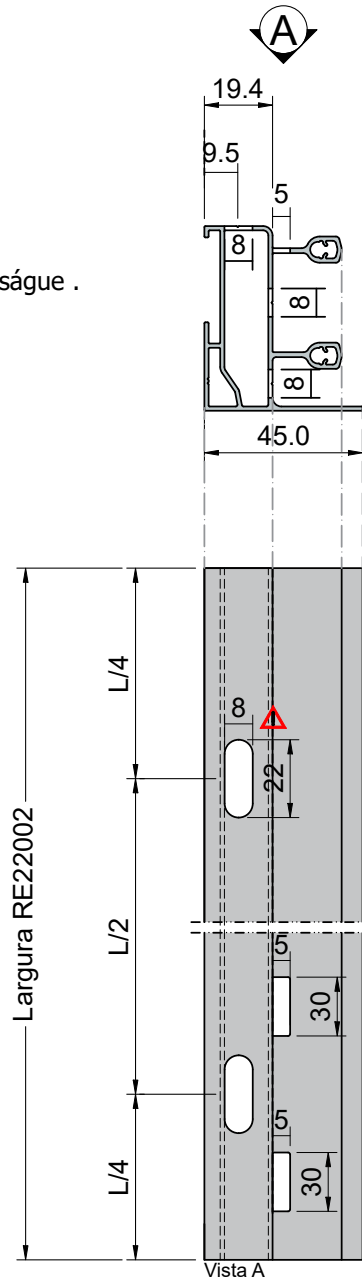

Esc.: 1:2

⚠ ATENÇÃO:

O diâmetro dos furos e oblongos do dreno podem variar dependendo do fornecedor. Conferir as dimensões nos catálogos dos fornecedores do componente.

Perfil: RE-22012

USI 11.A

ESCALA 1:7
Usinagem Trilho 02 Planos para Janela 04 Folhas

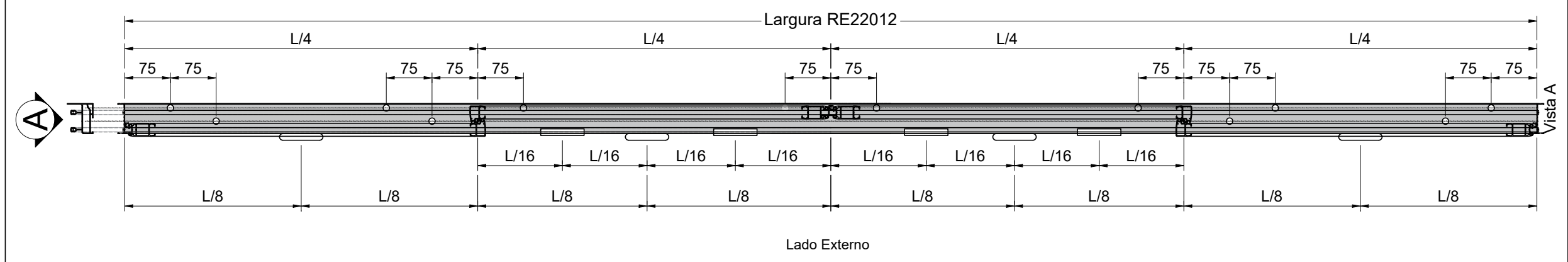
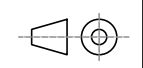
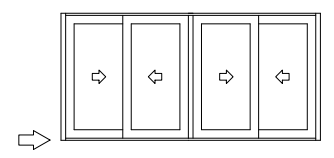

Perfil: **RE-22012**
USI 11.B

ESCALA 1:2
 usinagem trilho 02 planos para janela 04 folhas

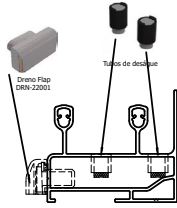
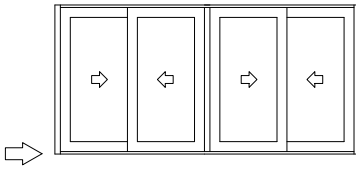
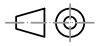

Representação dos Drenos e Tubos de deságue .

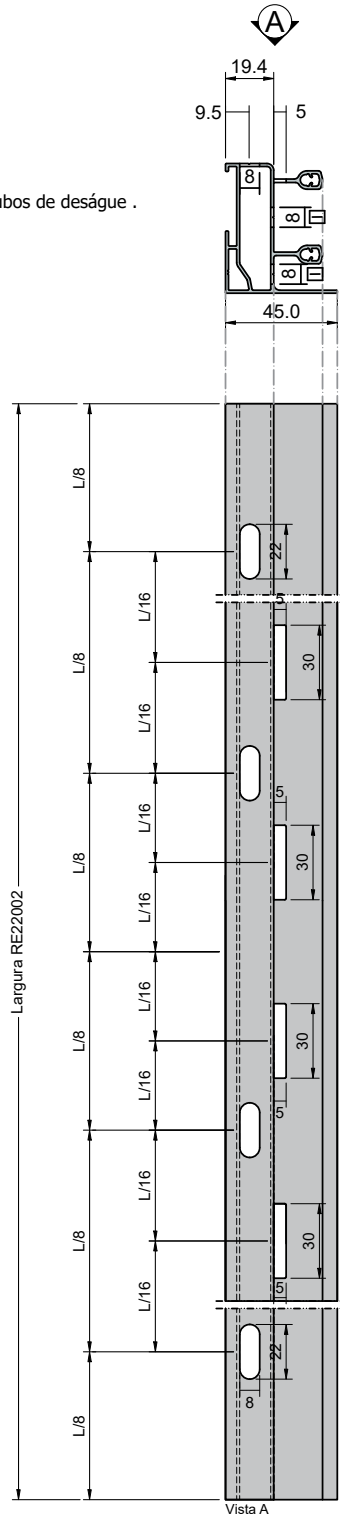

Vista A Esc.: 1:1

▲ ATENÇÃO:

O diâmetro dos furos e oblongos do dreno podem variar dependendo do fornecedor.
 Conferir as dimensões nos catálogos dos fornecedores do componente.

Perfil: **RE-22012**
USI 11.A

ESCALA 1:7
Usinagem Trilho 02 Planos para Janela 04 Folhas

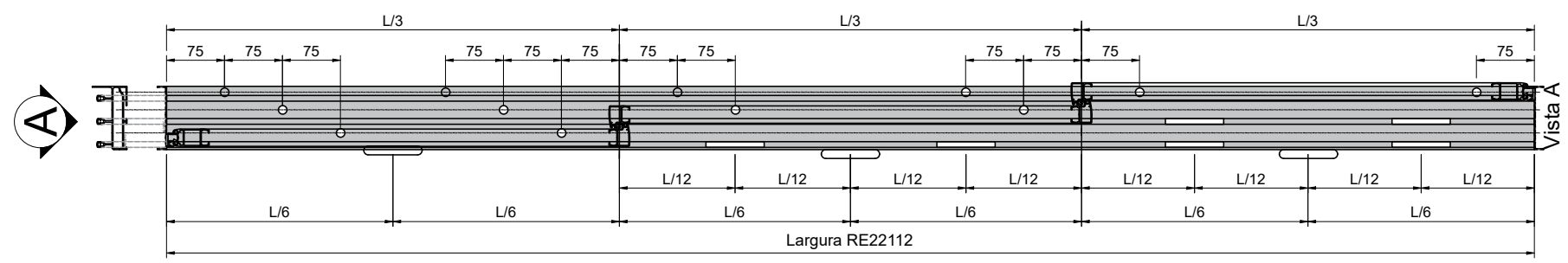
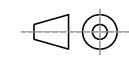
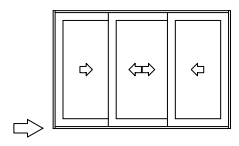

Perfil: **RE-22112**
USI 10.B

ESCALA 1:2

Usinagem Trilho Inferior de 03 Planos,
 para uso em peças com 03 Folhas.

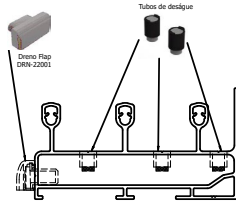
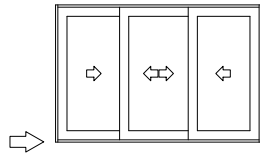

Representação dos Drenos e Tubos de deságue .

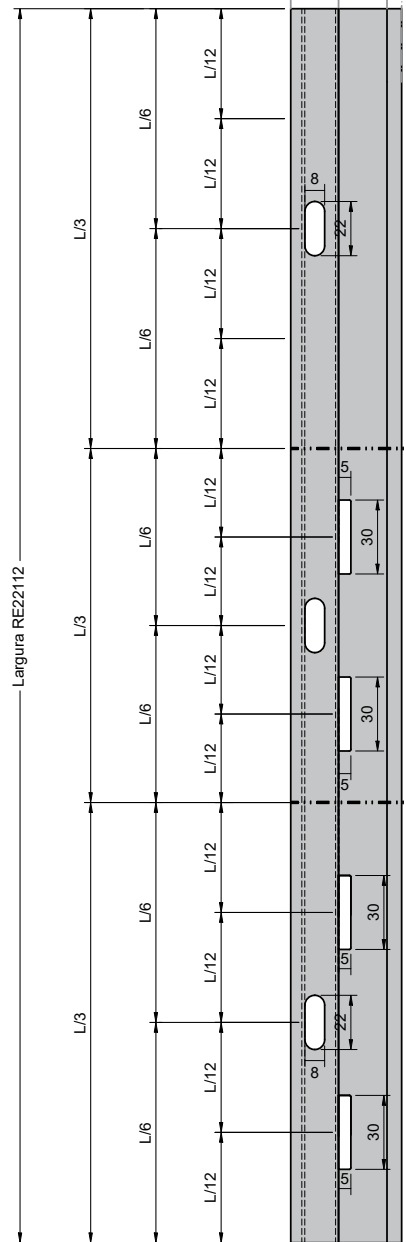
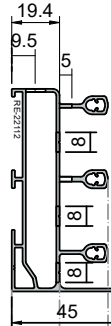

Vista A Esc.: 1:2

⚠ ATENÇÃO:

O diâmetro dos furos e oblongos do dreno podem variar dependendo do fornecedor.
 Conferir as dimensões nos catálogos dos fornecedores do componente.

Perfil: RE-22112
USI 12.A

ESCALA 1:10

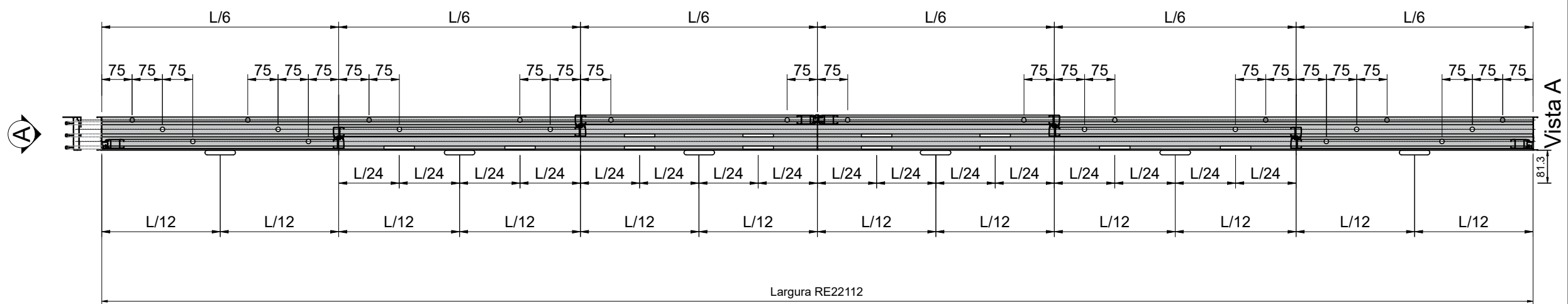
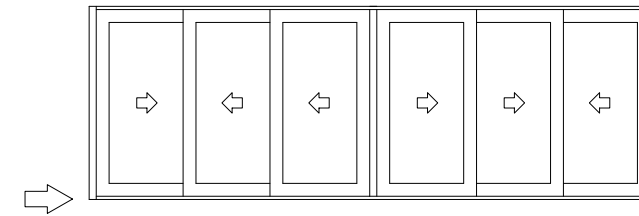
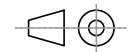

Lado Externo

Perfil: RE-22112

USI 12.B

ESCALA 1:2

Usinagem Trilho Inferior de 03 Planos,
para uso em peças com 06 Foltas.

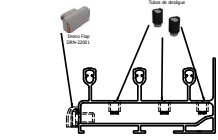
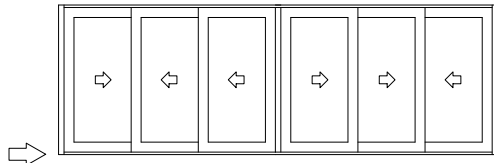

Representação dos Drenos e Tubos de deságue .

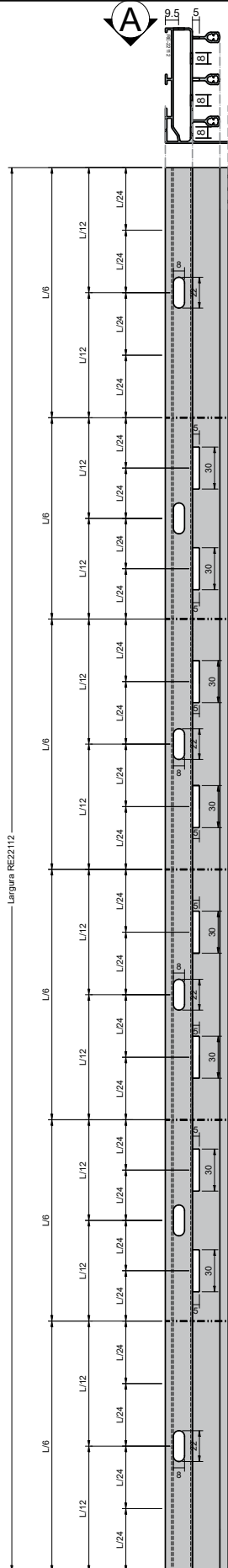

Vista A
Esc.: 1:2

▲ ATENÇÃO:
O diâmetro dos furos e oblongos do dreno podem variar dependendo do fornecedor.
Conferir as dimensões nos catálogos dos fornecedores do componente.

Perfil:	RE-22401
USI 14	RE-22402
	RE-22403
	RE-22404
	RE-22405

ESCALA 1:1

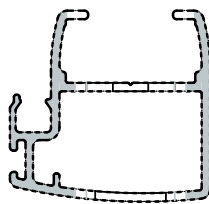
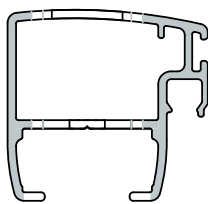
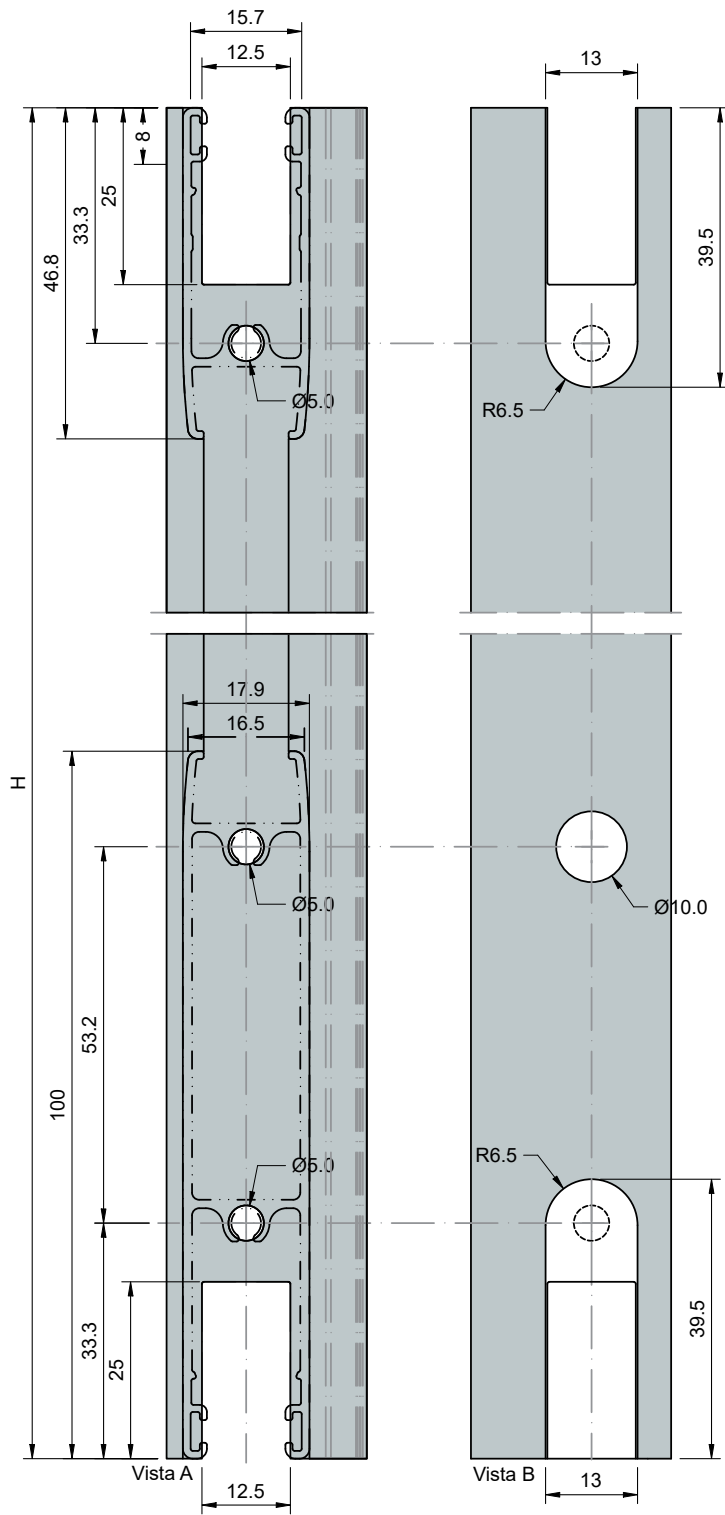
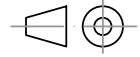

Perfil: RE-22301
USI 15 RE-22302
 RE-22303
 RE-22304
 RE-22401
 RE-22402
 RE-22403
 RE-22404
 RE-22405

ESCALA 1:1

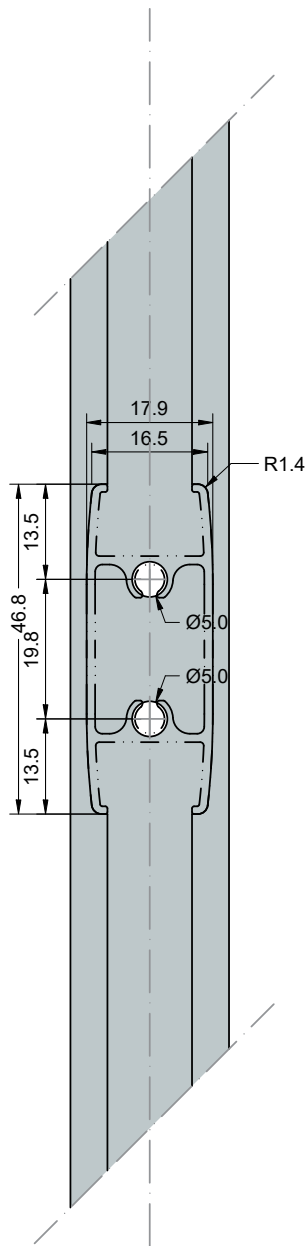
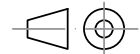

Vista A

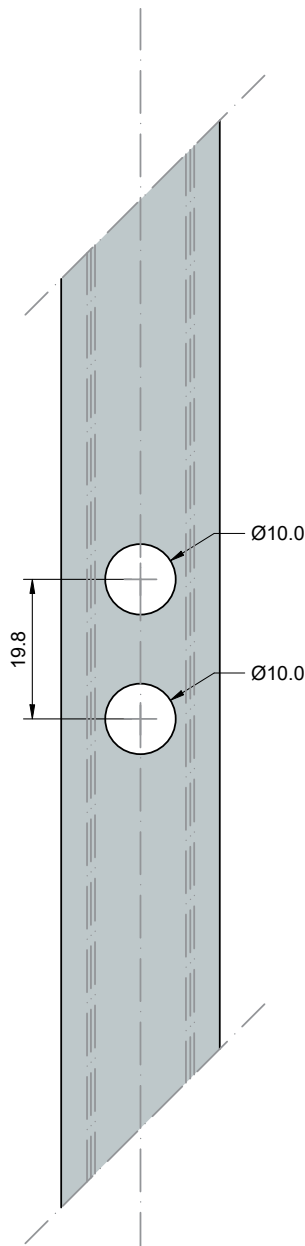

Vista B

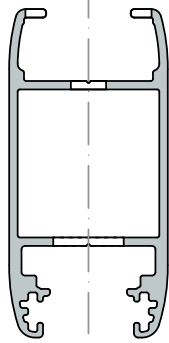
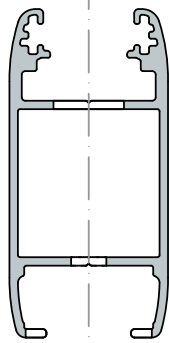

Perfil: RE-22302
USI 16 RE-22402

ESCALA 1:1

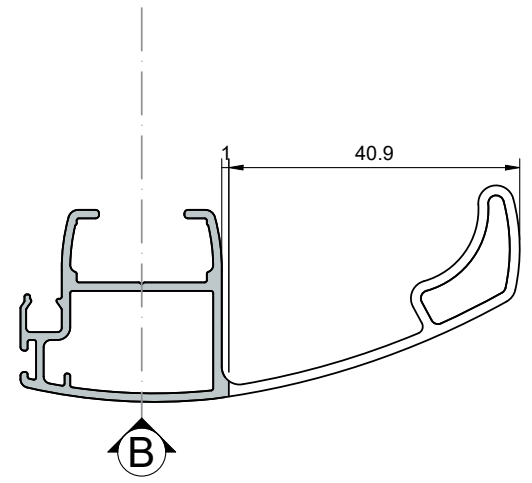
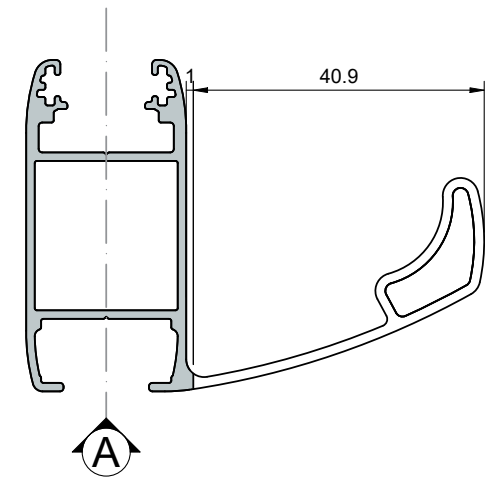
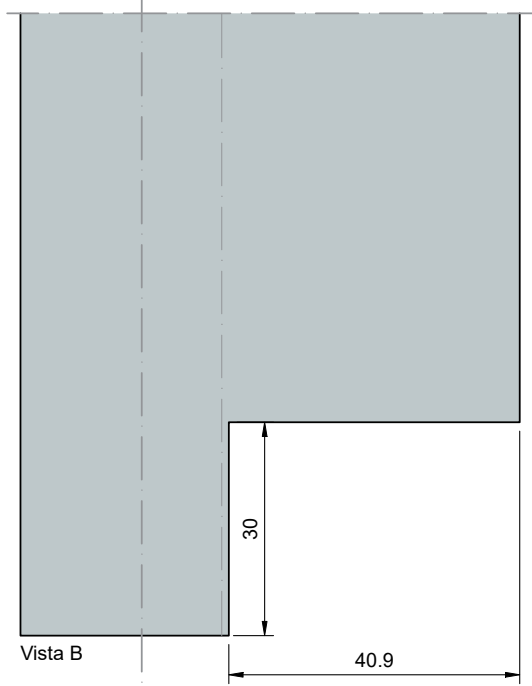
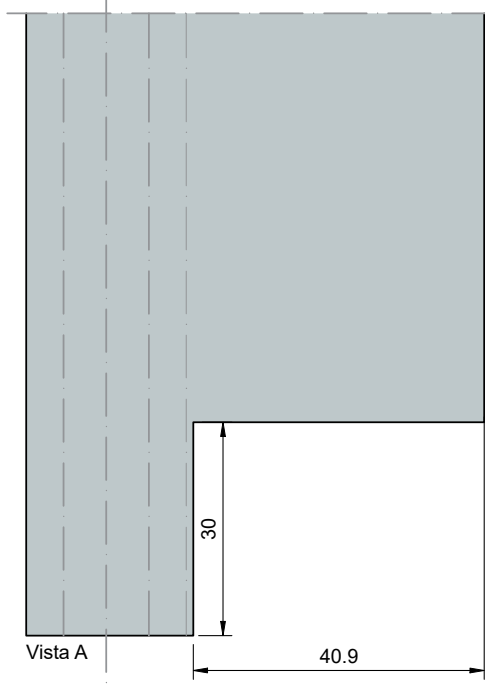
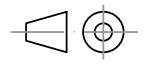
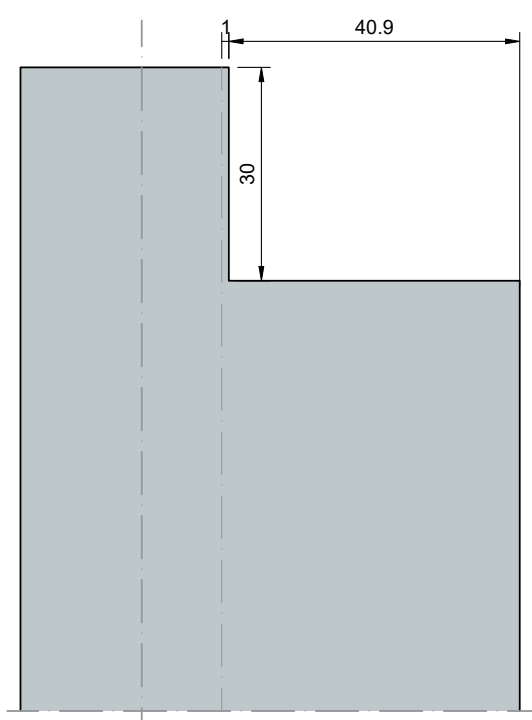
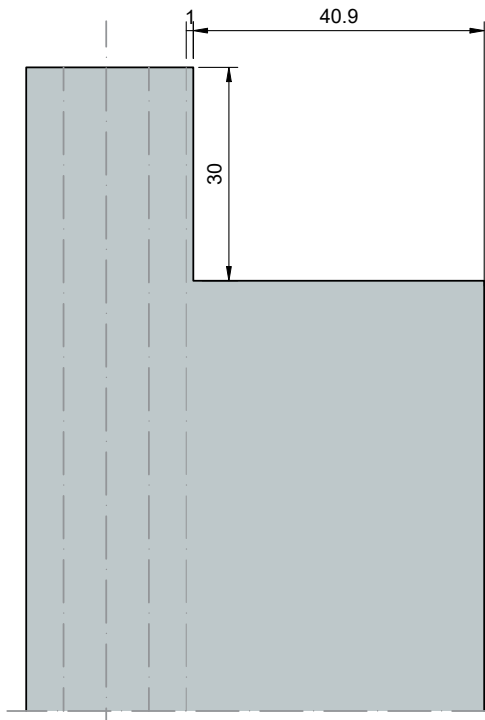

Perfil: RE-22303
USI 17 RE-22403
ESCALA 1:1

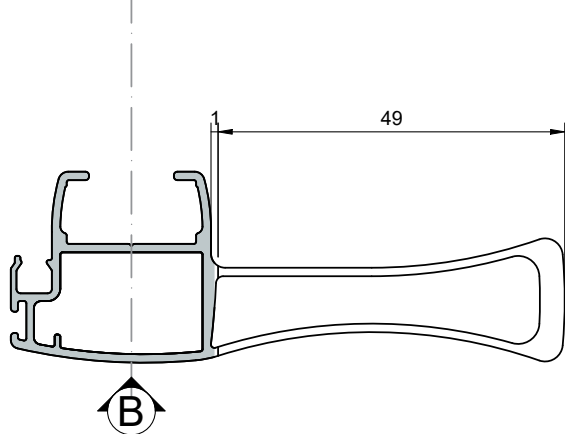
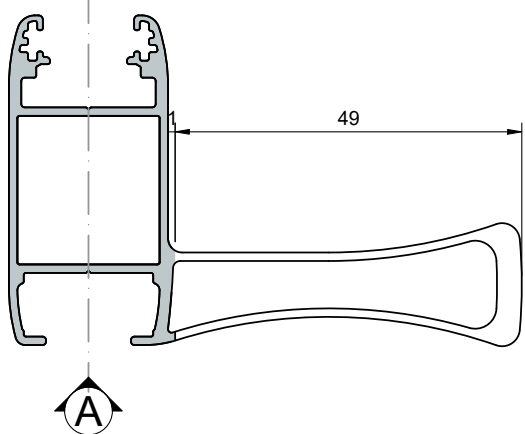
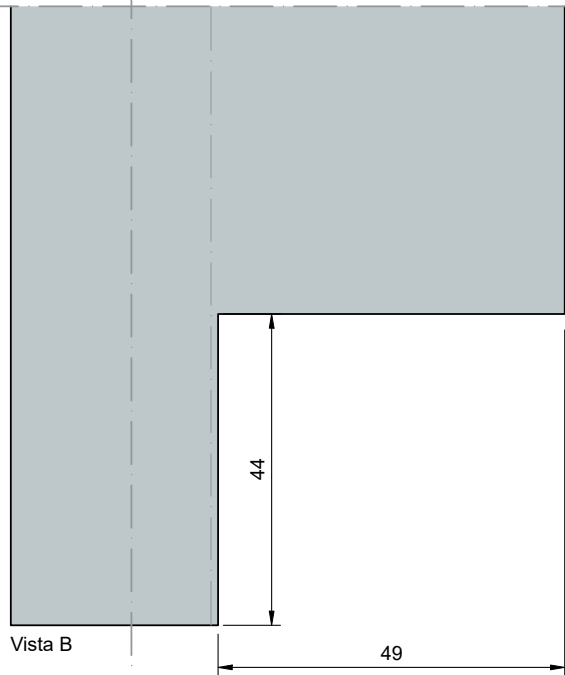
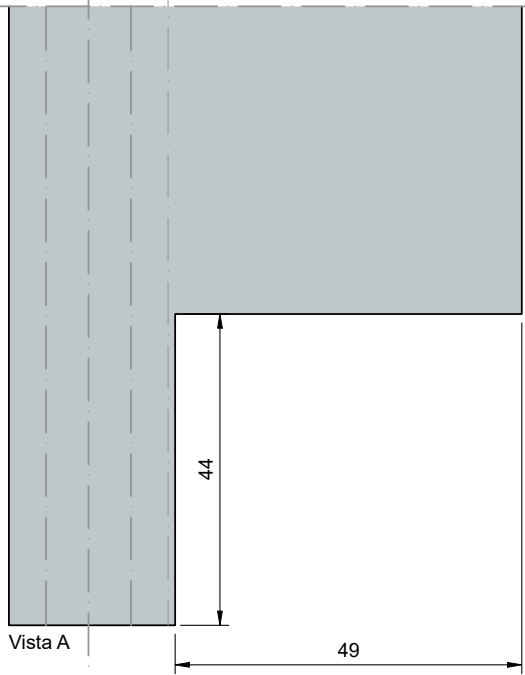
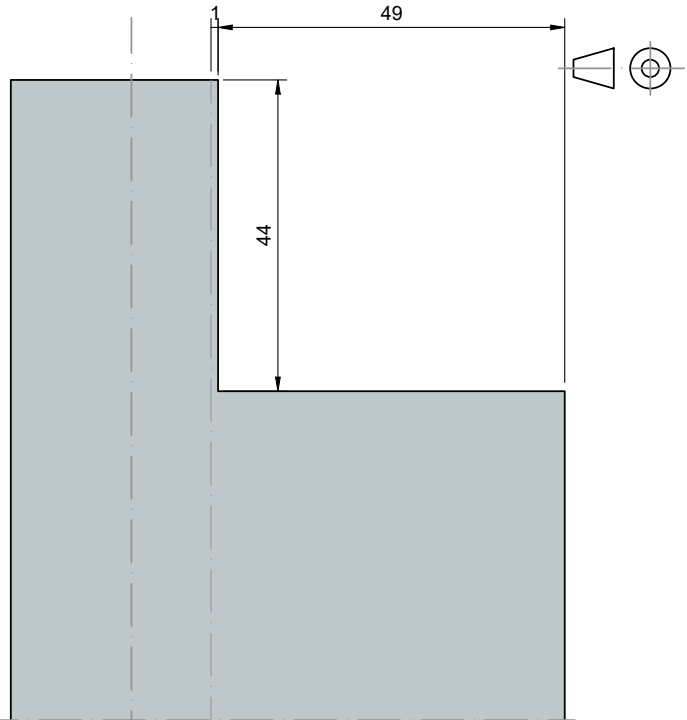
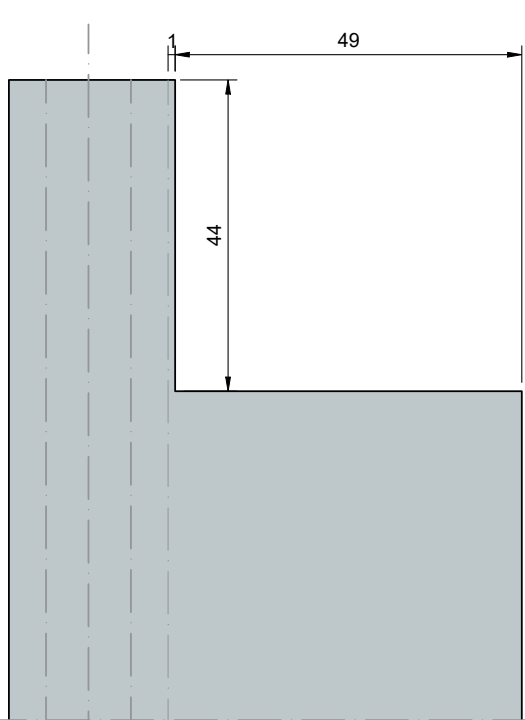

Perfil: RE-22304
USI 18 RE-22404

ESCALA 1:1

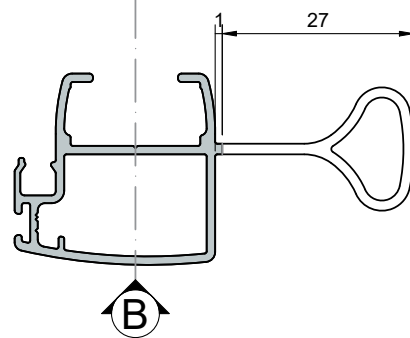
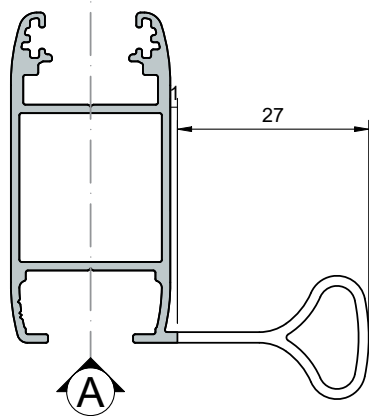
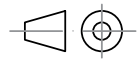
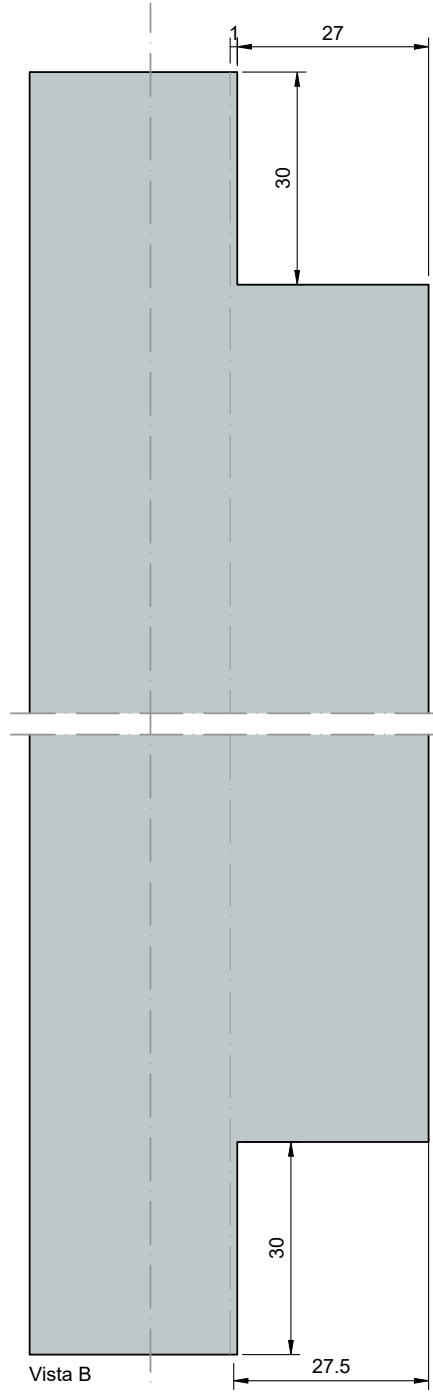
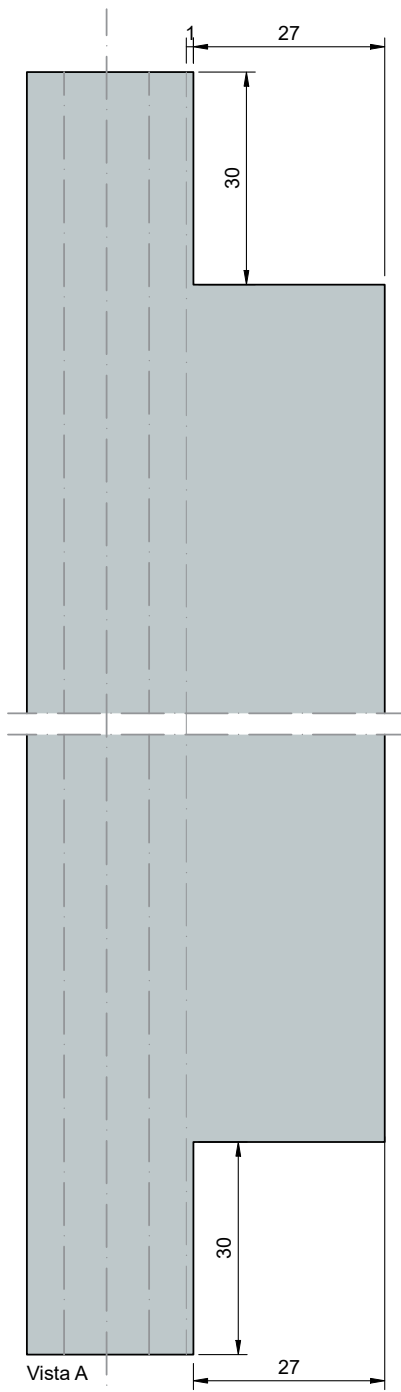

Perfil:

RE-22901

USI 19

ESCALA 1:1

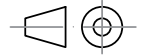

Vista A



Vista B

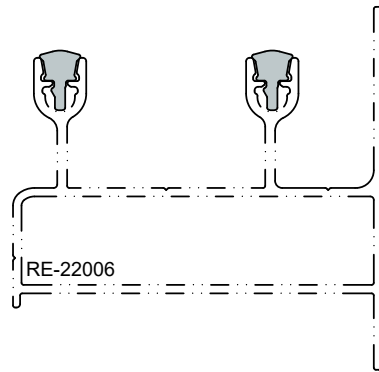

RE-22006

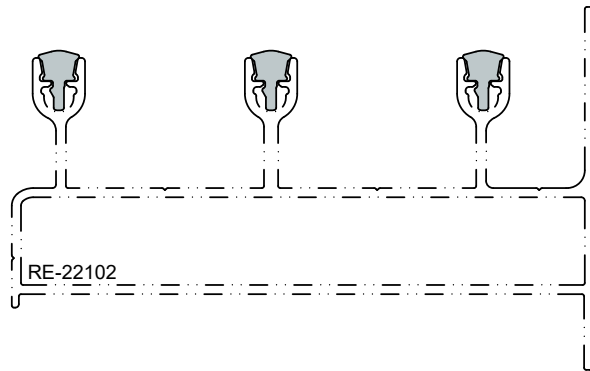

RE-22102

Perfil: **ALG-1005**
USI 21 **ALG-1008**
ESCALA 1:1

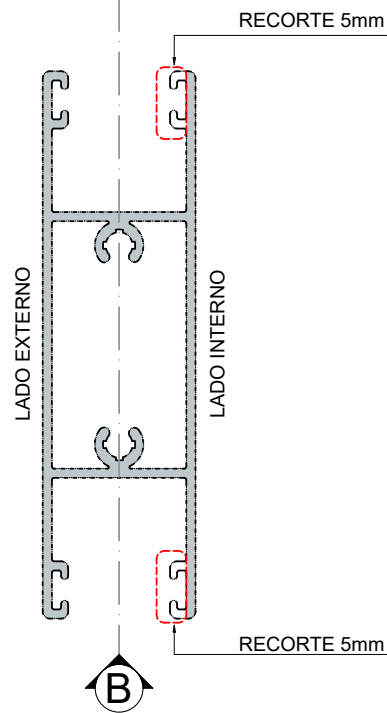
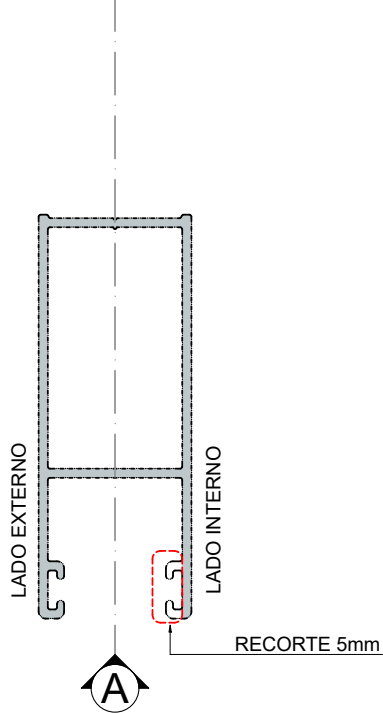
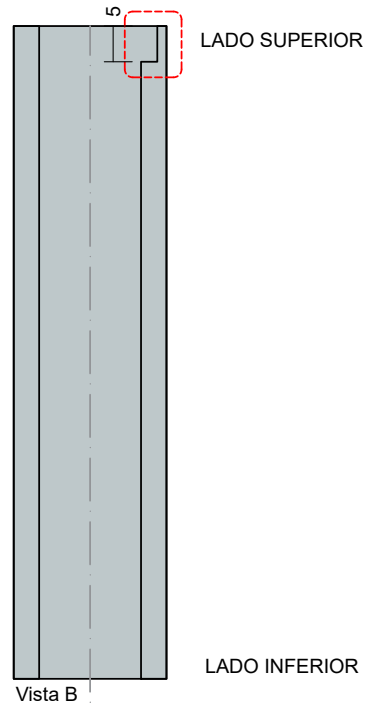
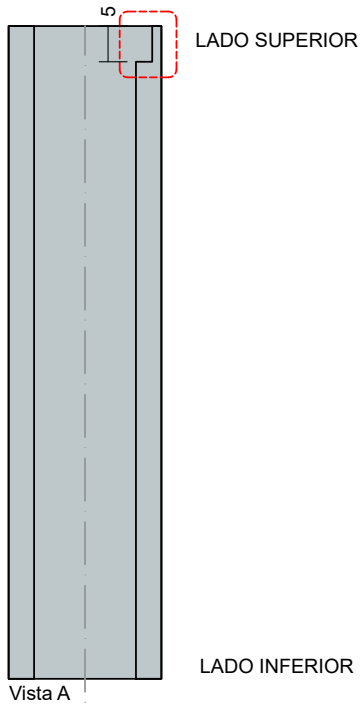
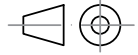

Perfil: **ALG-1004**

USI 22

ESCALA 1:1

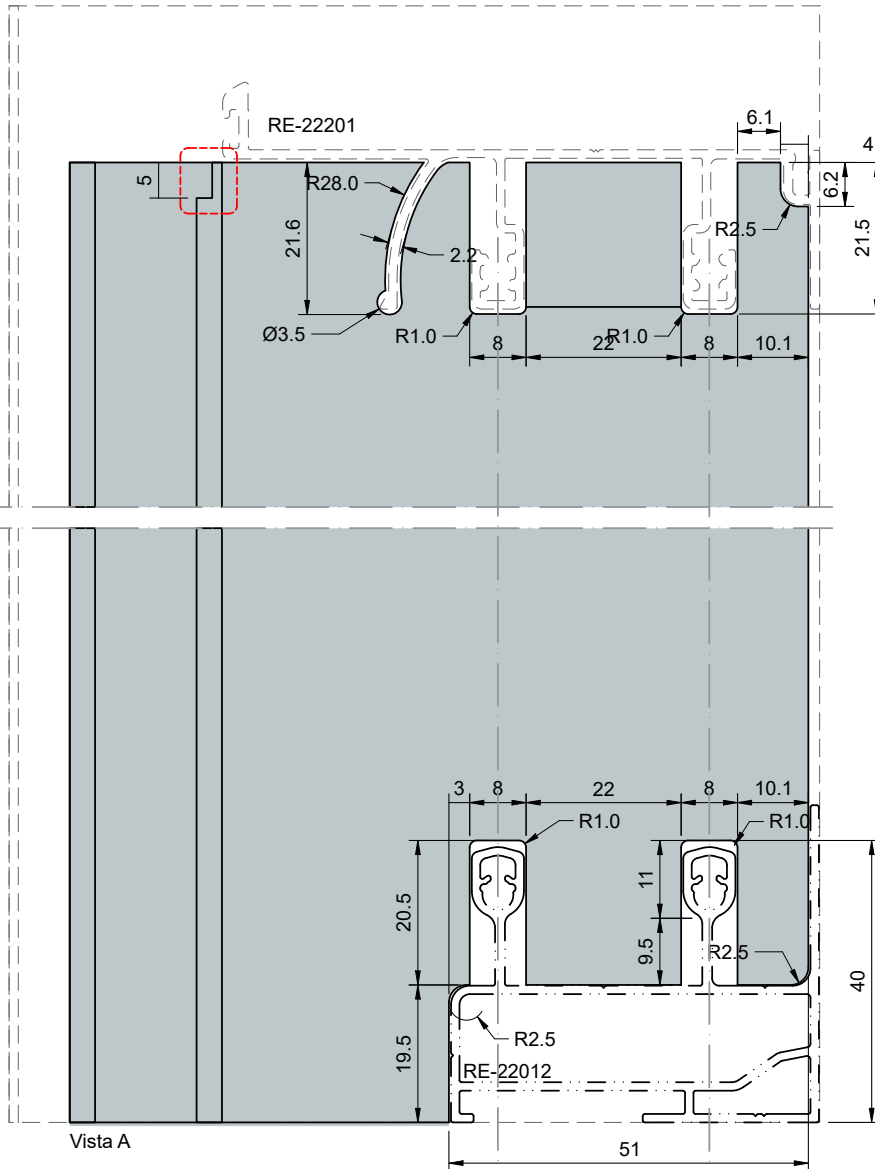
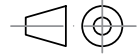

Vista A

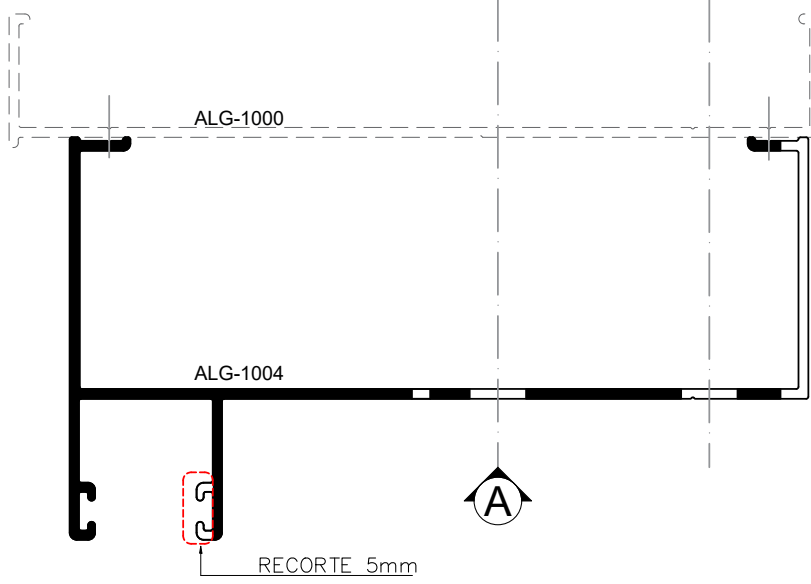

Perfil: **ALG-1004**

USI 23

ESCALA 1:1

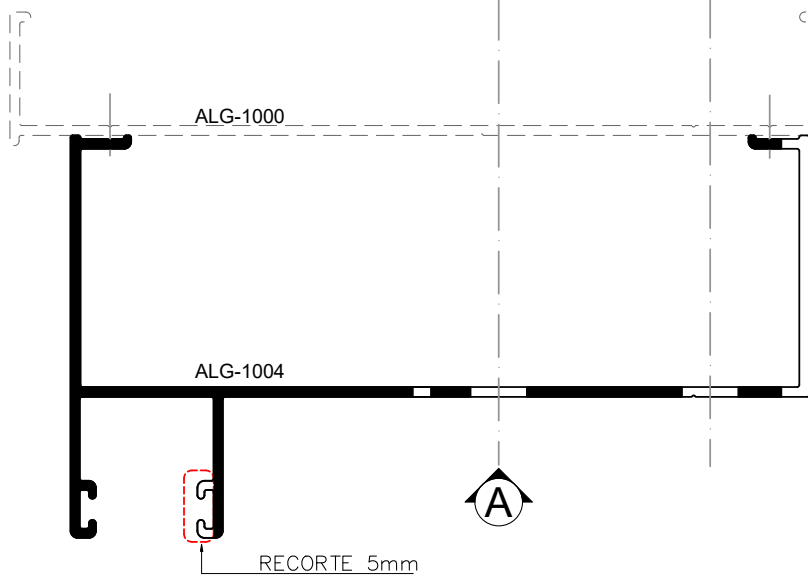
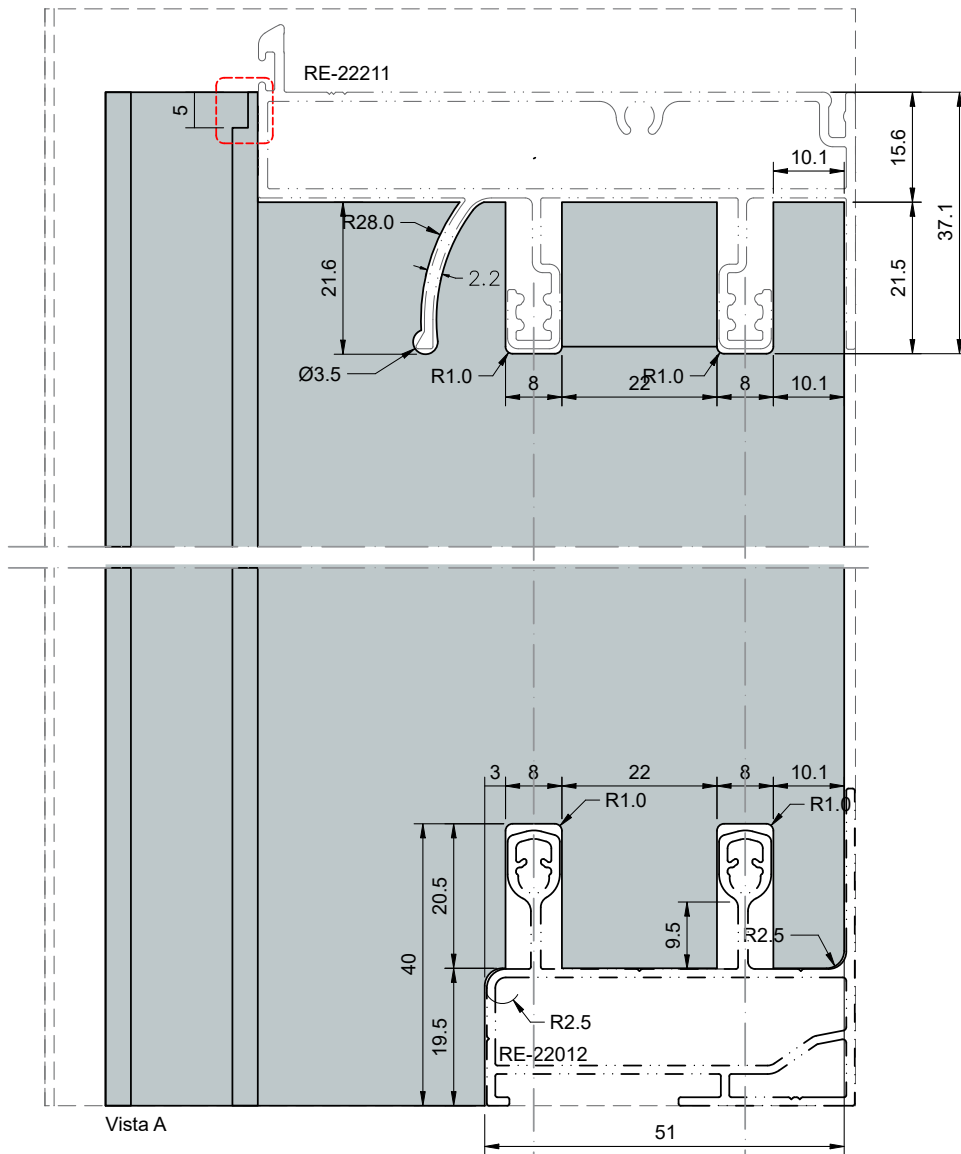
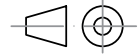

Perfil: **ALG-1004**

USI 23.A

ESCALA 1:1

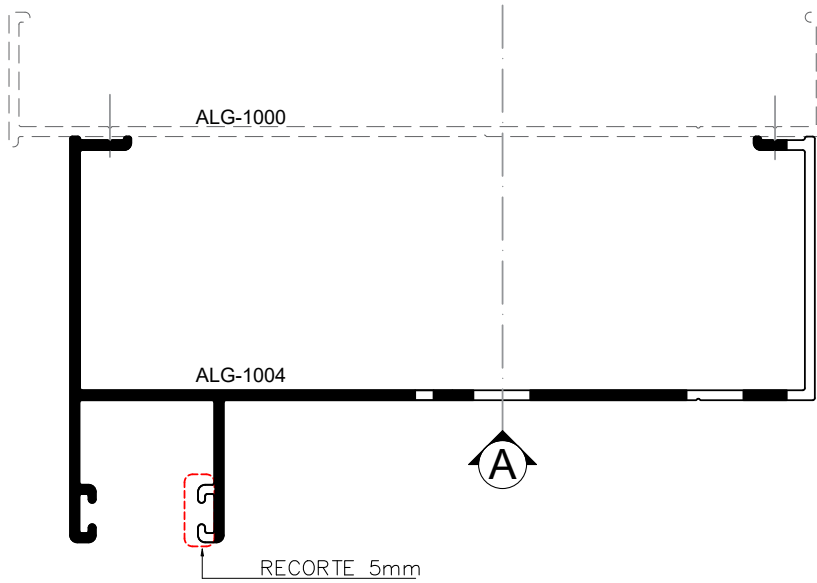
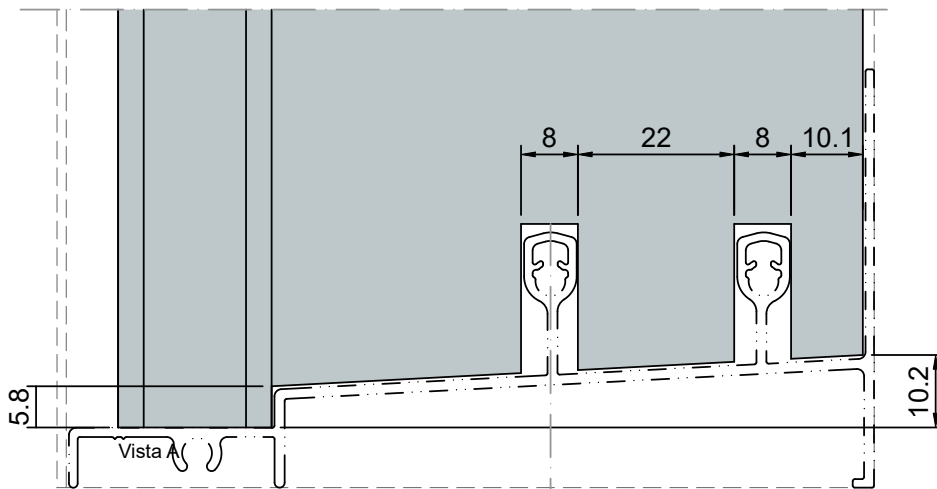
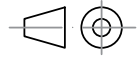

Perfil: **ALG-1004**

USI 23.B

ESCALA 1:1

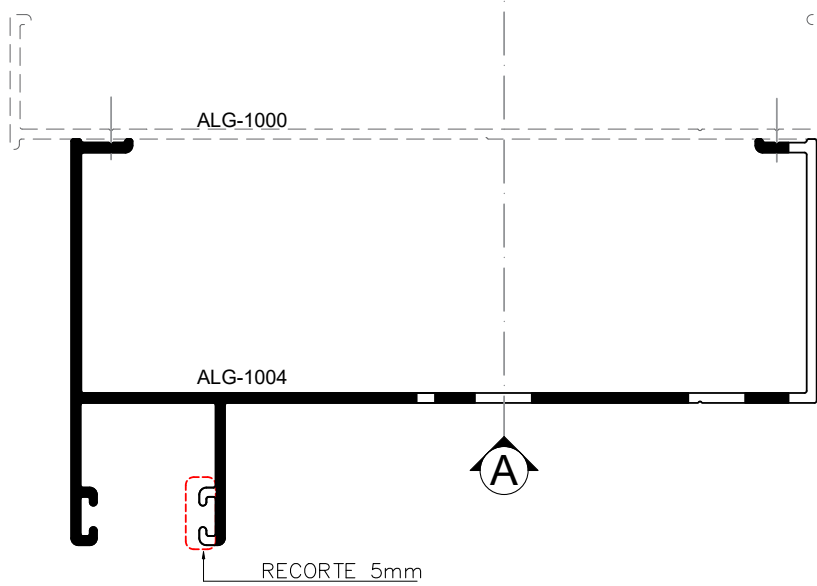
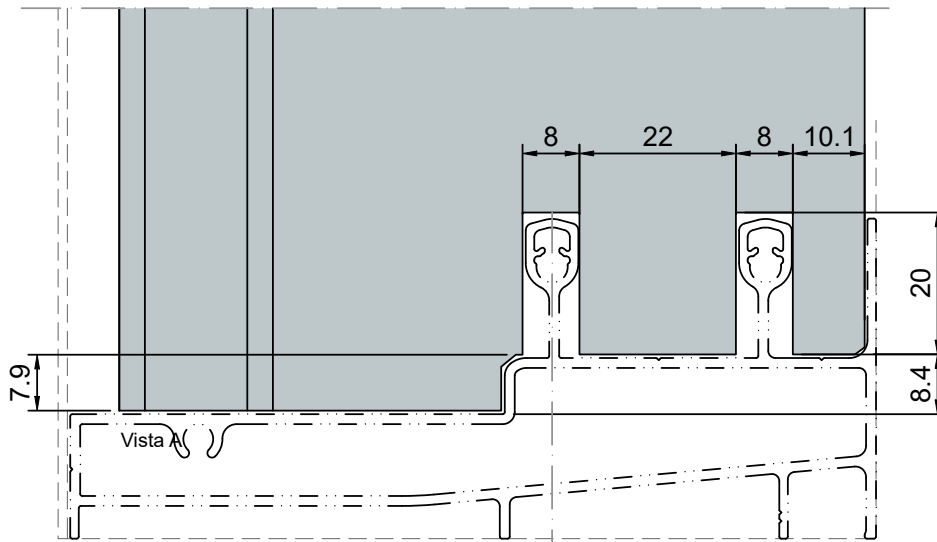
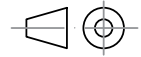

Perfil: **ALG-1000**
USI 24
ESCALA 1:1

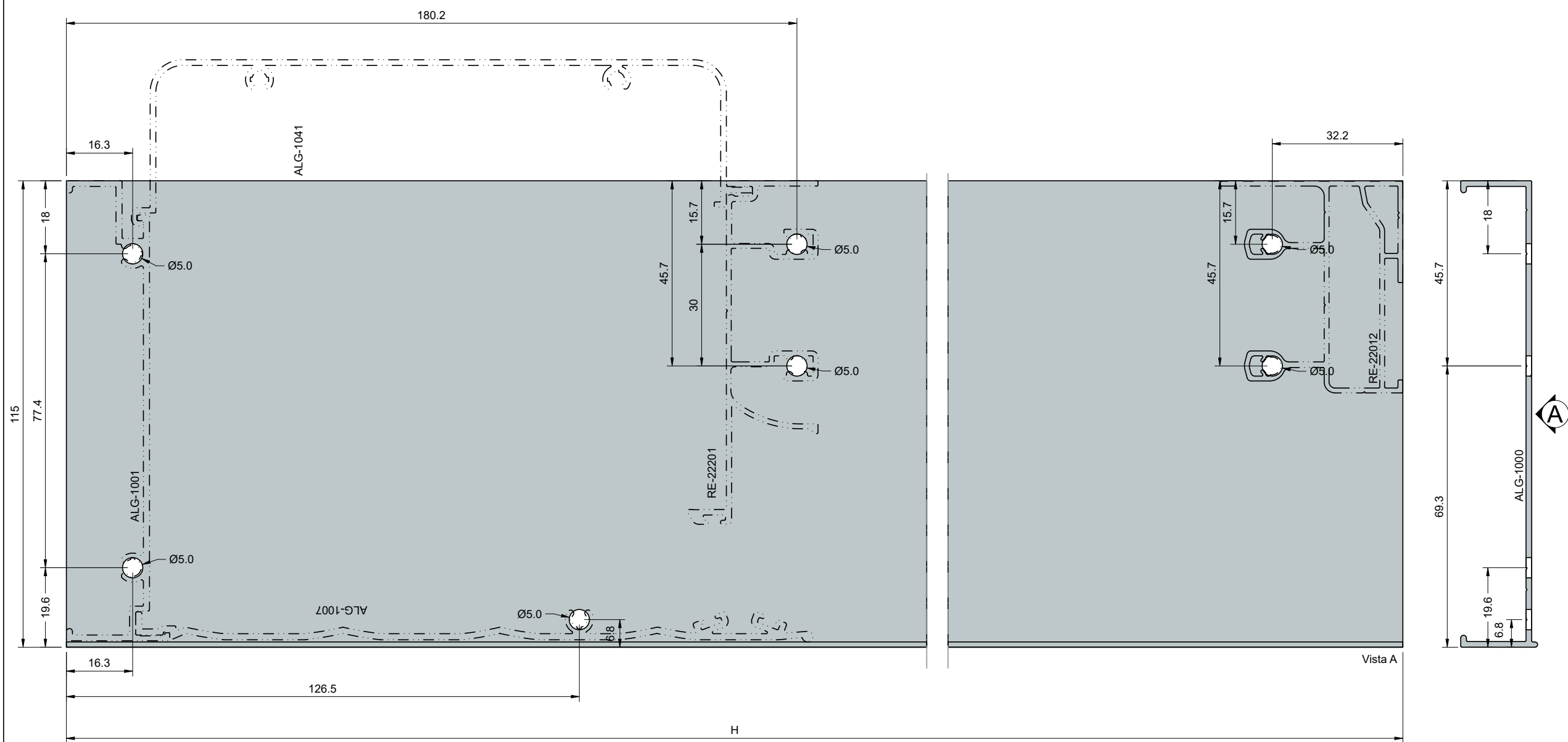
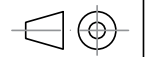

Perfil: **ALG-1000**
USI 25

ESCALA 1:1

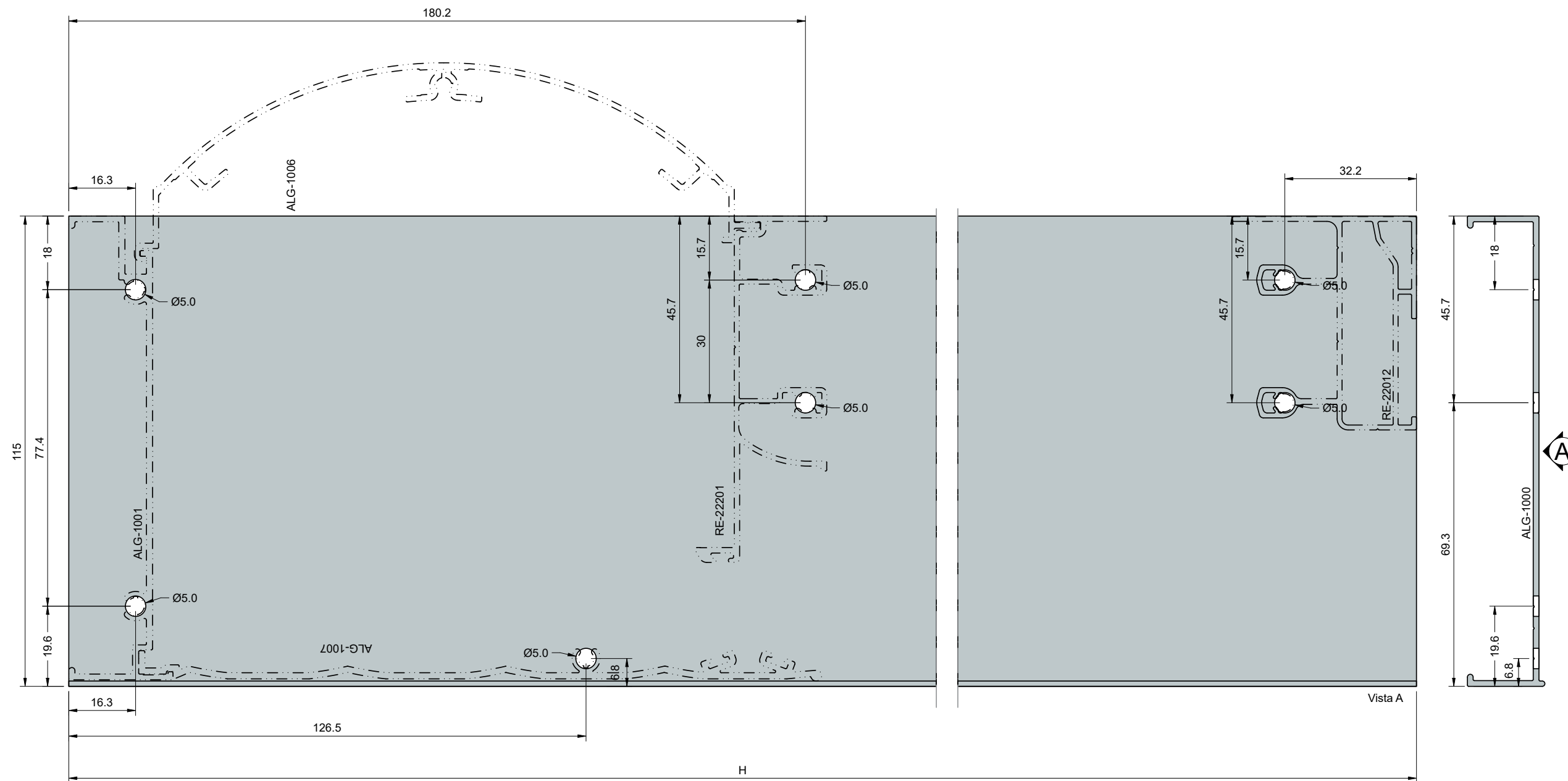
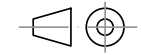

Perfil: **ALG-1000**
USI 26

ESCALA 1:1

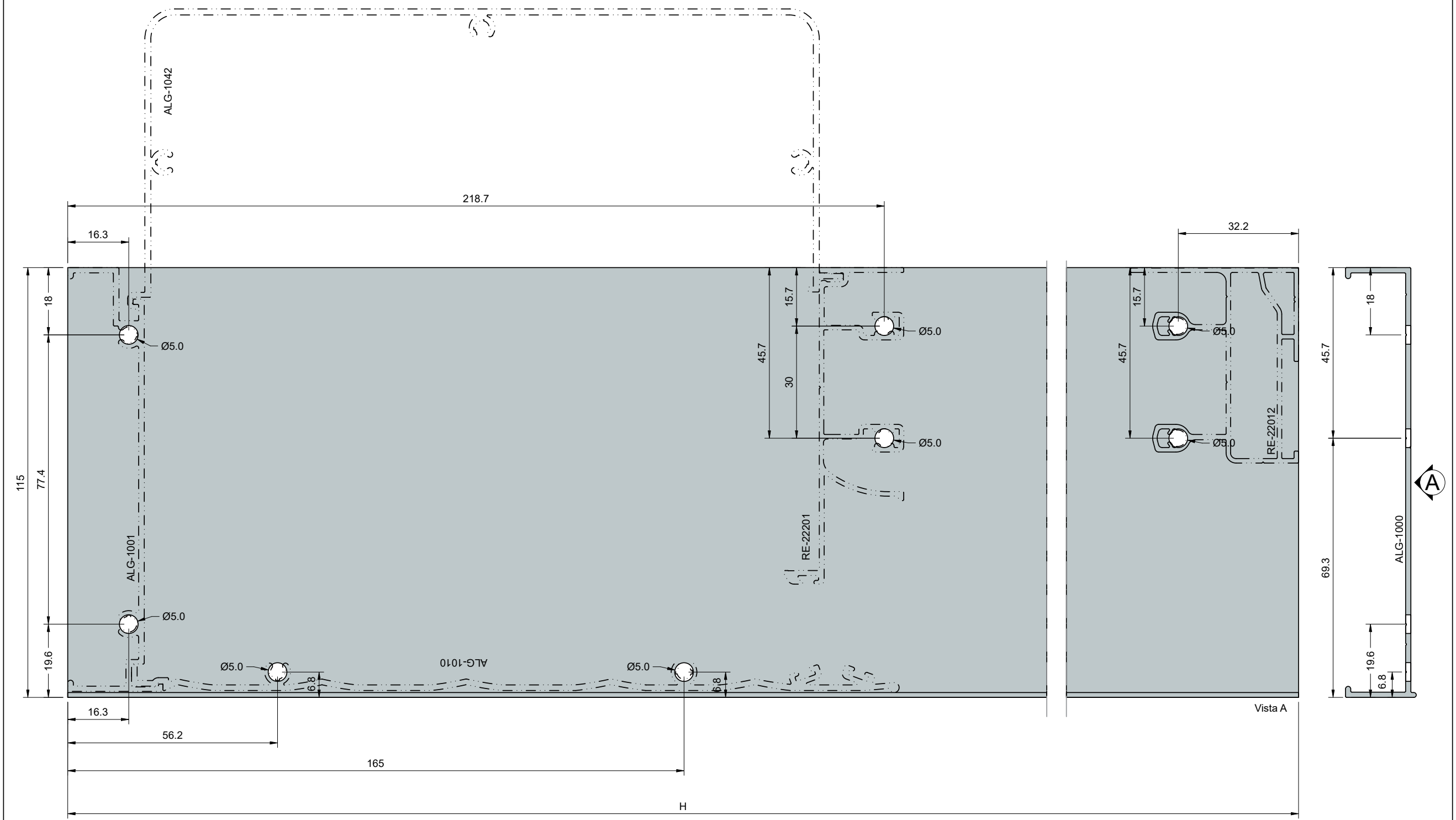
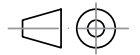

Perfil: **ALG-1000**

USI 27

ESCALA 1:1

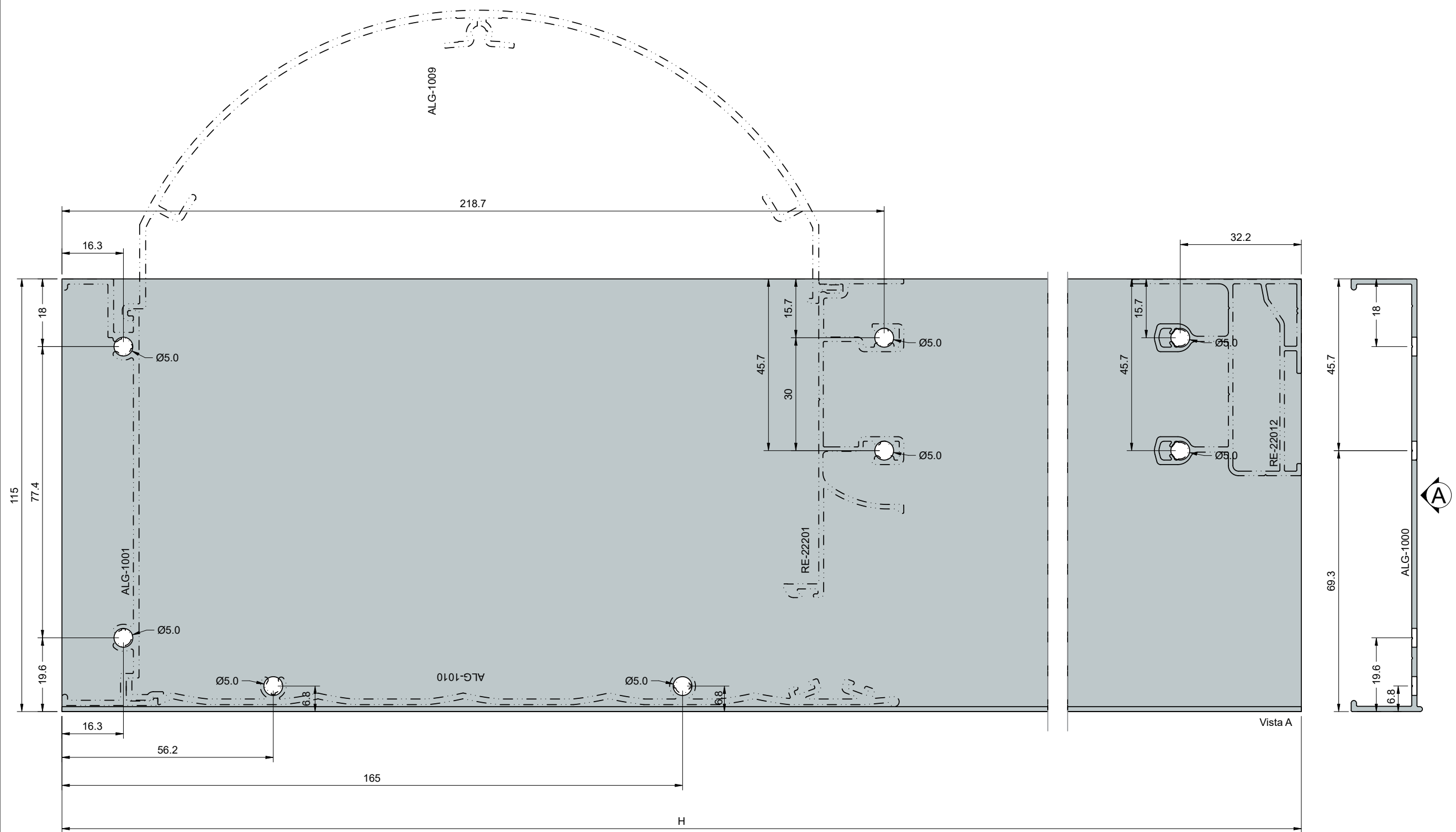
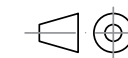

Perfil: **ALG-1000**
USI 28

ESCALA 1:1

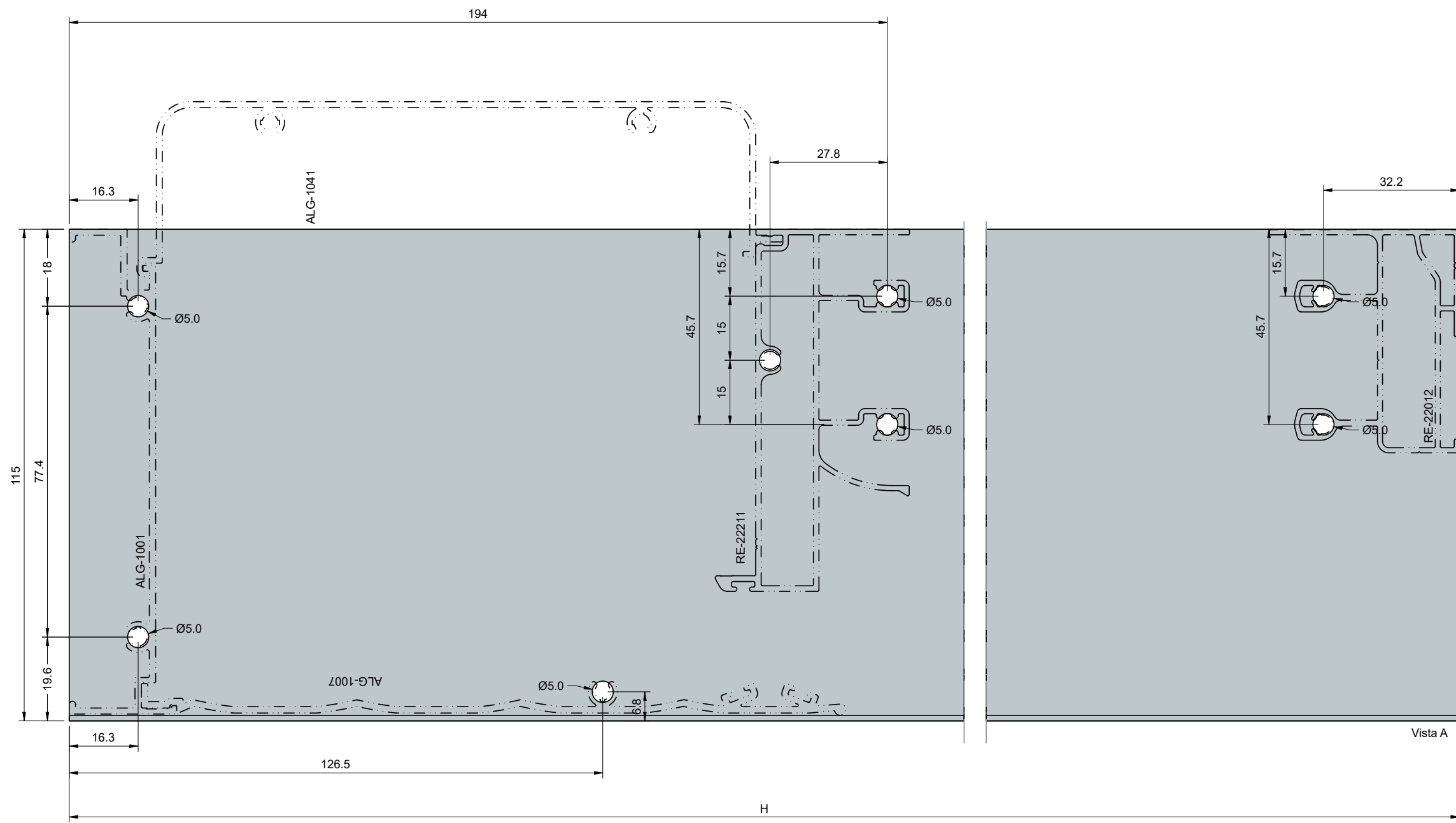
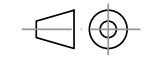

Perfil: **ALG-1000**
USI 29

ESCALA 1:1

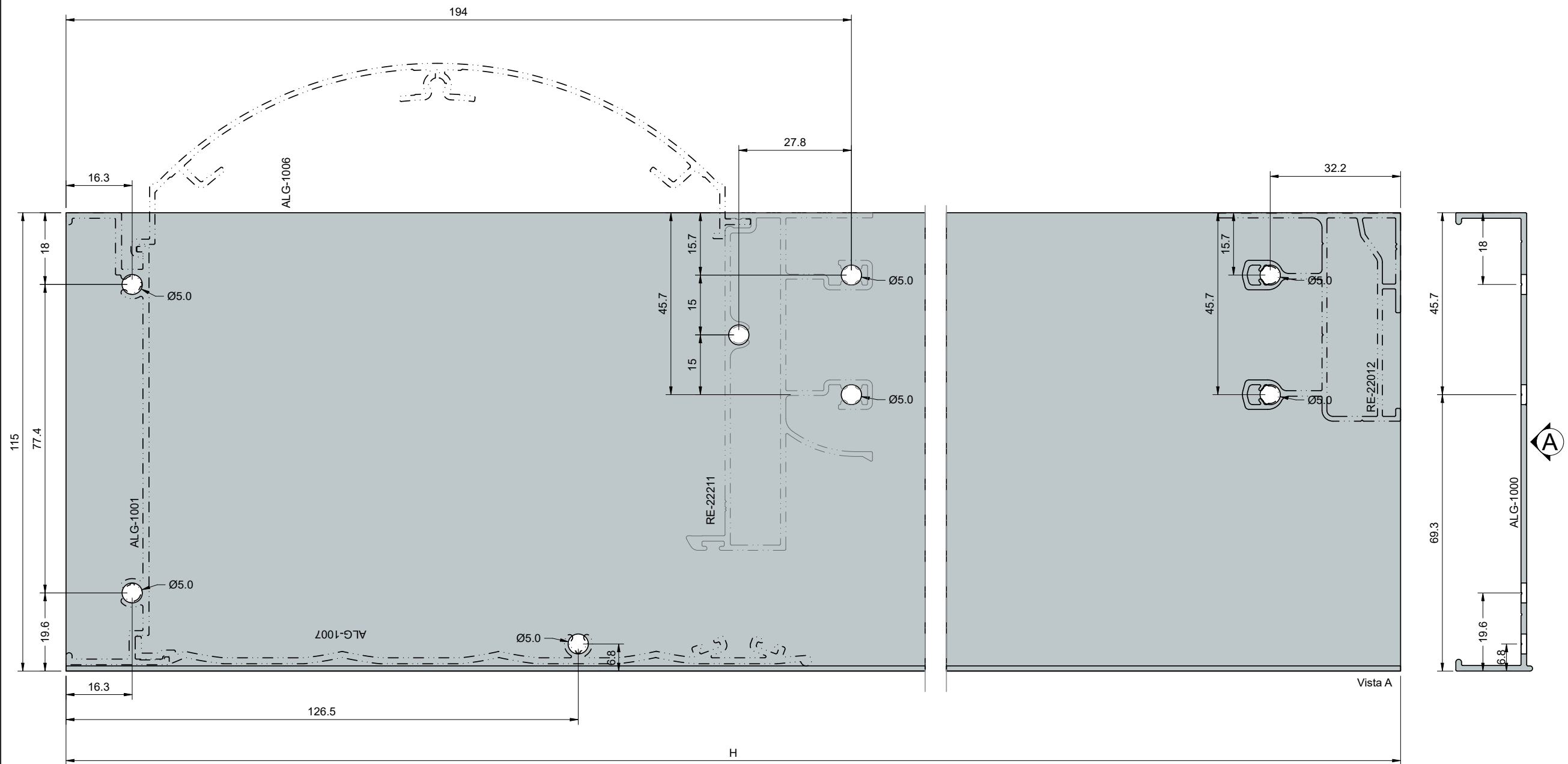
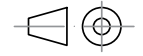

Perfil: **ALG-1000**
USI 30

ESCALA 1:1

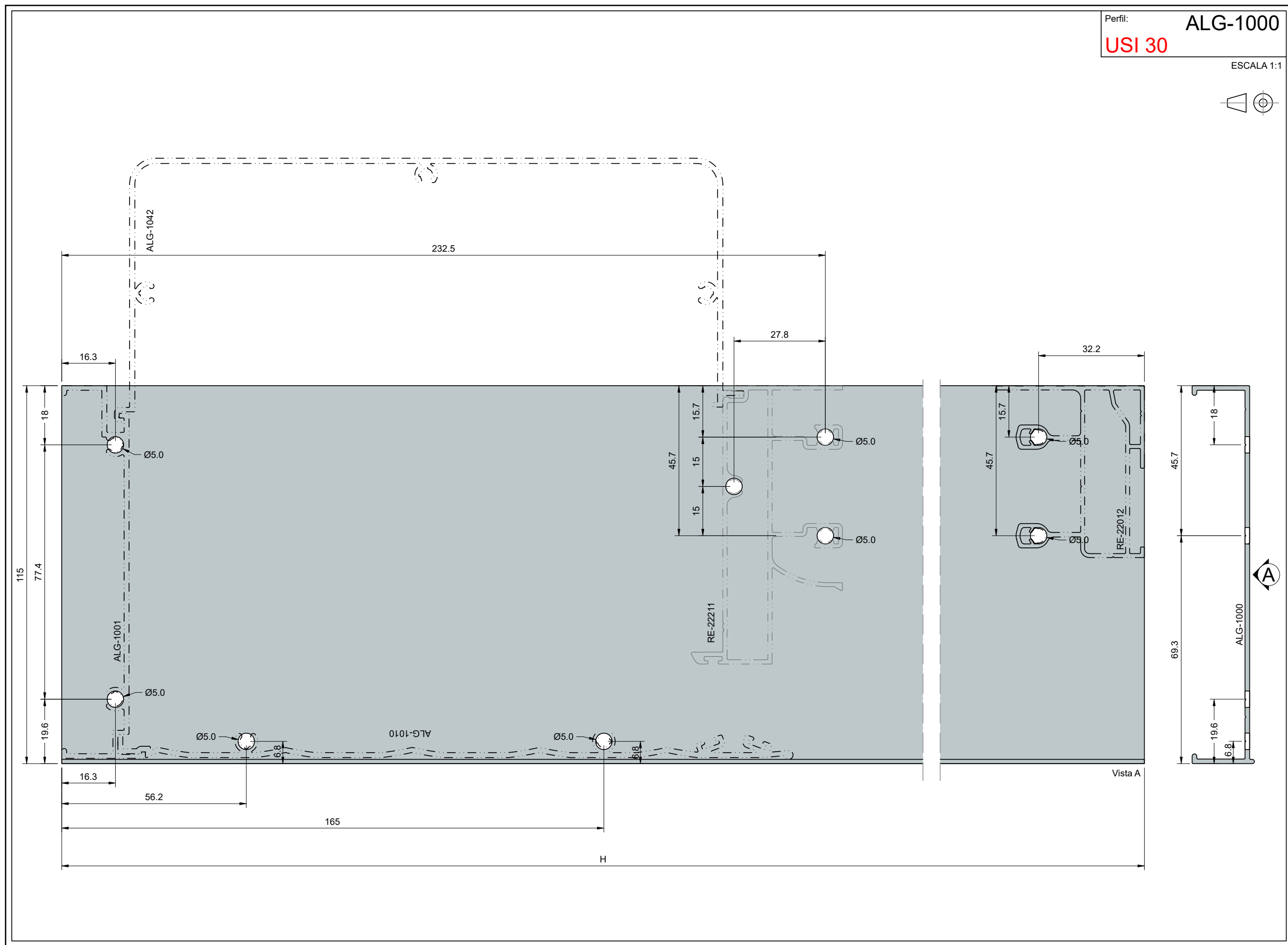
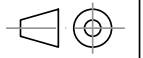

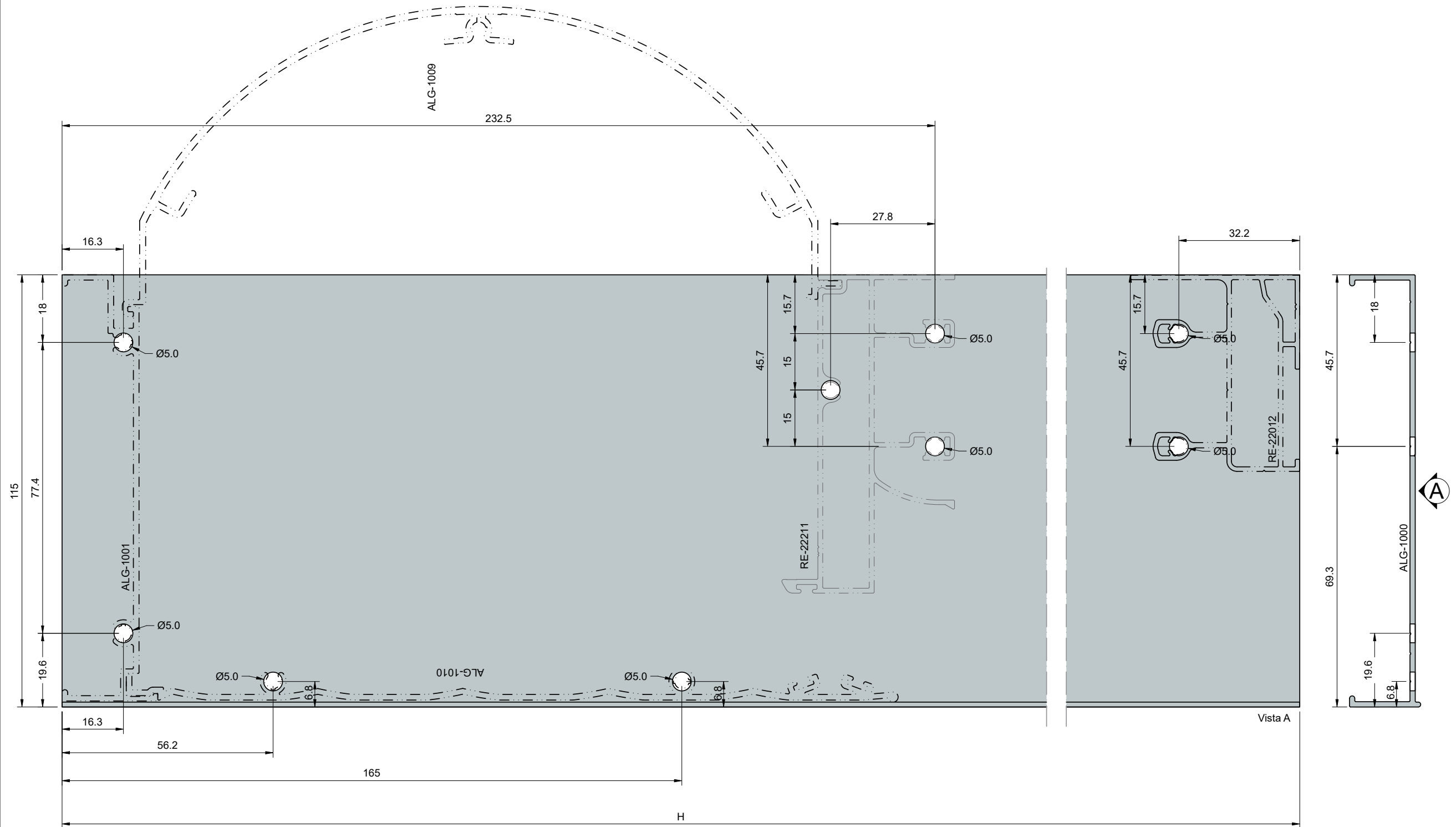
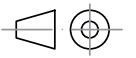

Perfil: **ALG-1000**
USI 31.A

ESCALA 1:1

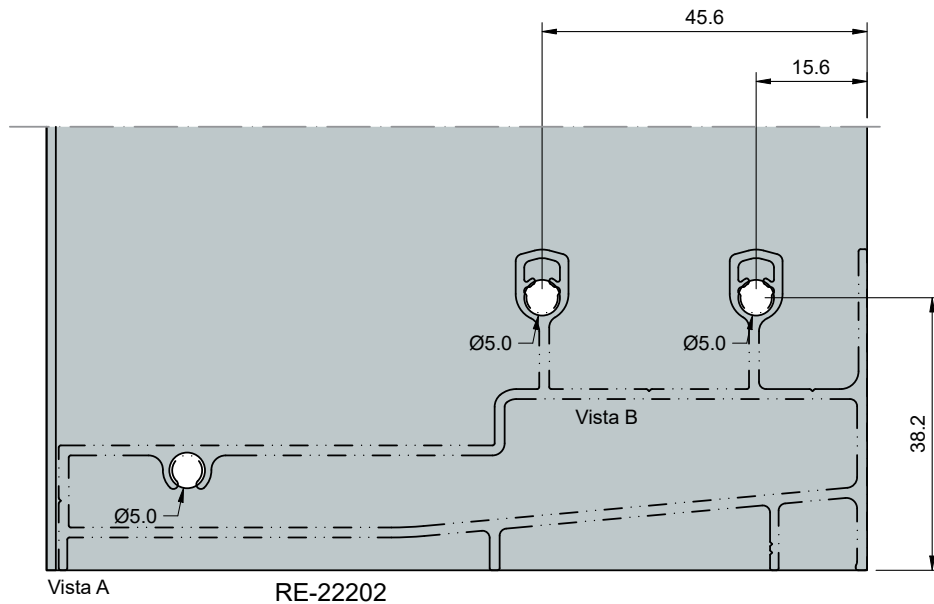
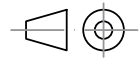

Vista A RE-22202

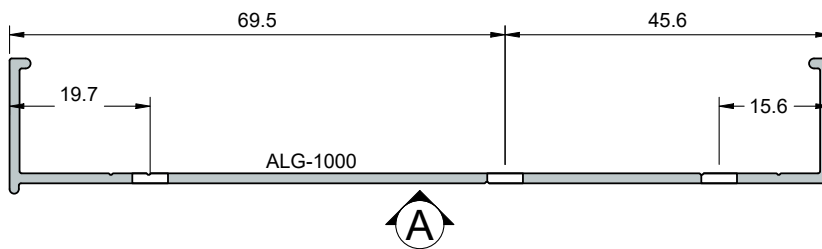

Perfil: **ALG-1000**

USI 31.B

ESCALA 1:1

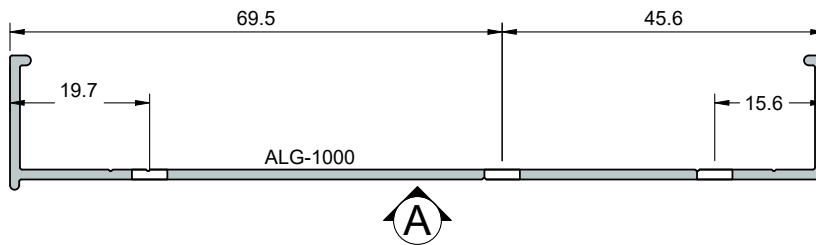
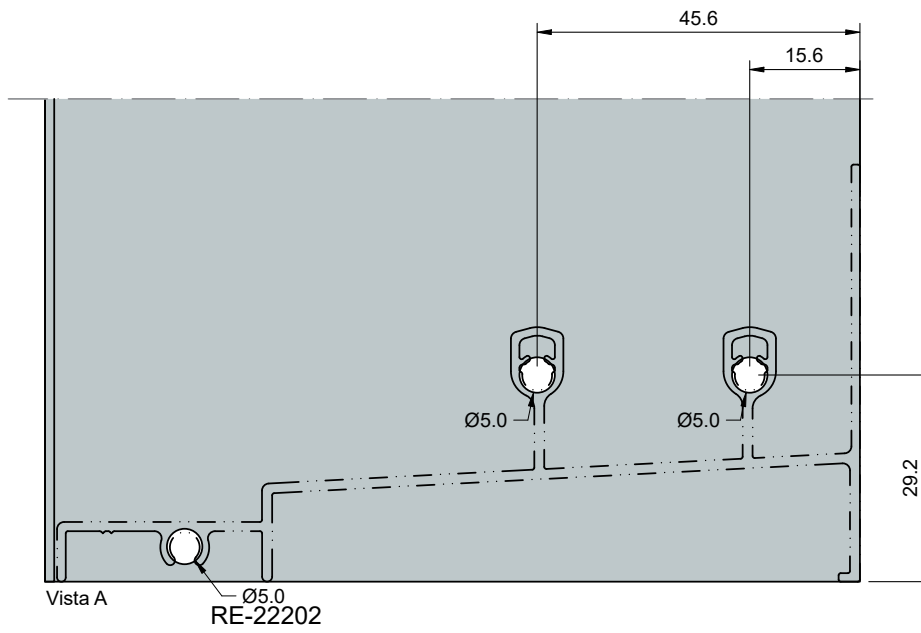
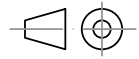

Perfil:

USI 32 RE-22902
 RE-22003
 RE-22004
 RE-22103
 RE-22104

ESCALA 1:1

usinagem marco lateral TRAVA FOLHA FIXA

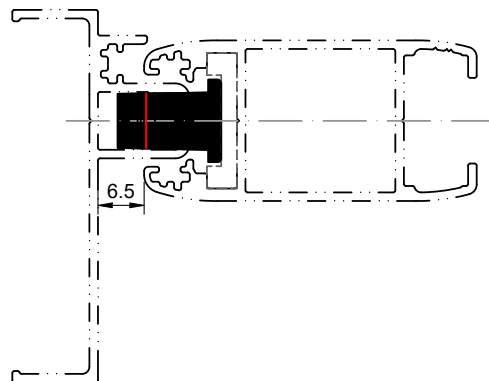
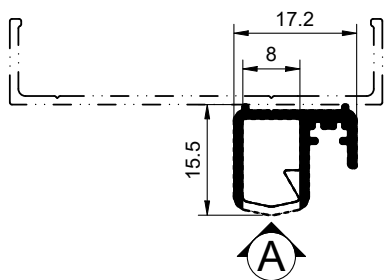
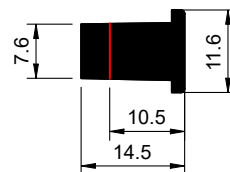
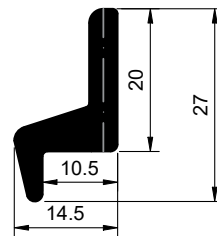
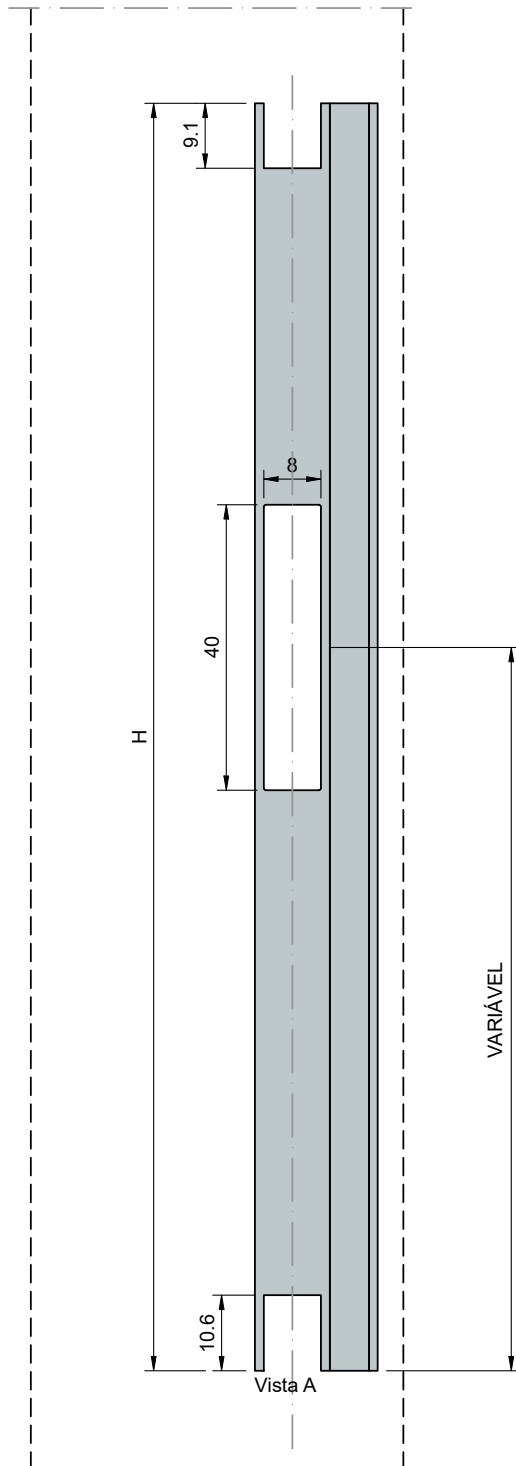
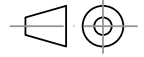

Perfil: RE-22301
USI 33A RE-22302
RE-22303
RE-22304

ESCALA 1:1
usinagem lingueta

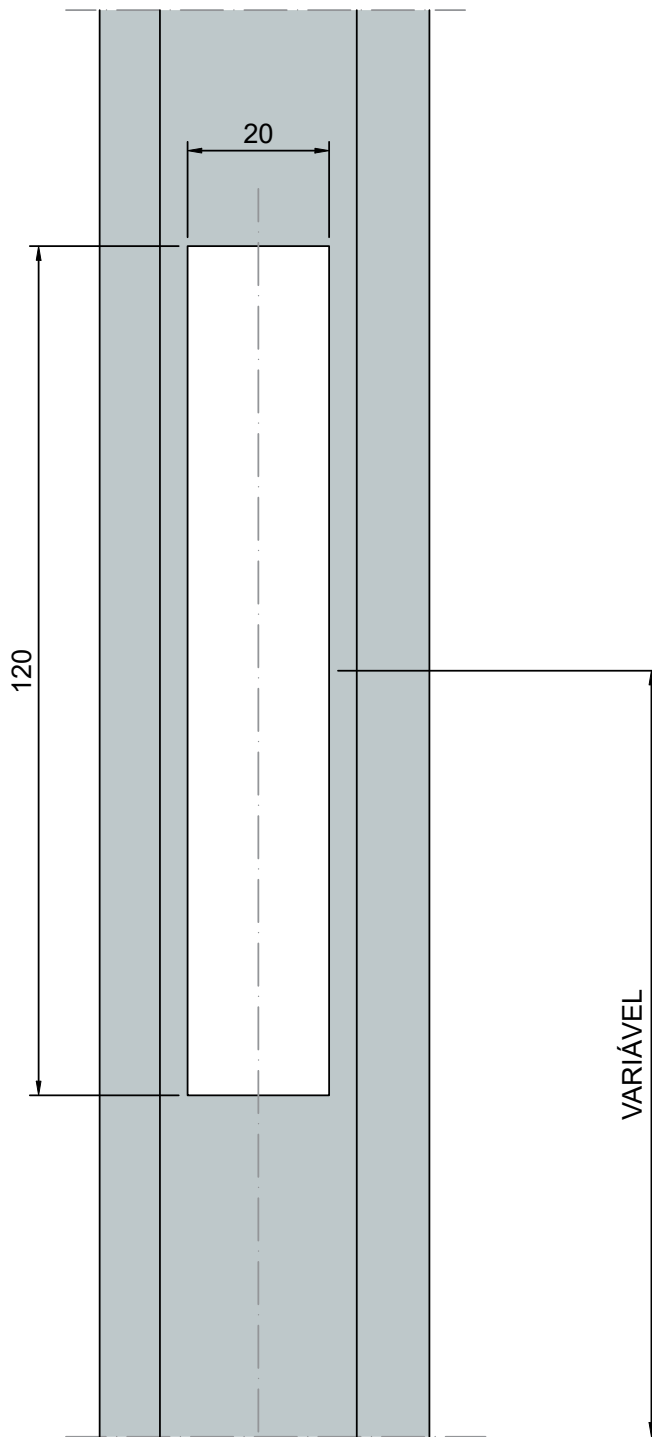
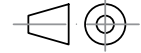

Vista A

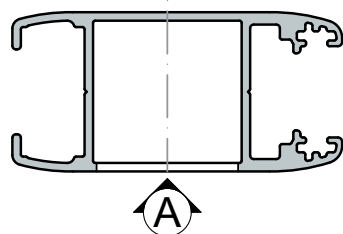

Perfil: RE-22301
USI 33 RE-22302
RE-22303
RE-22304

ESCALA 1:1
usinagem lingueta

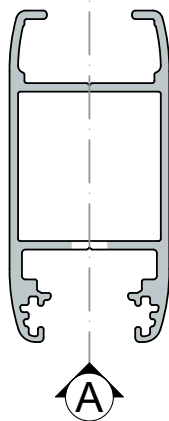
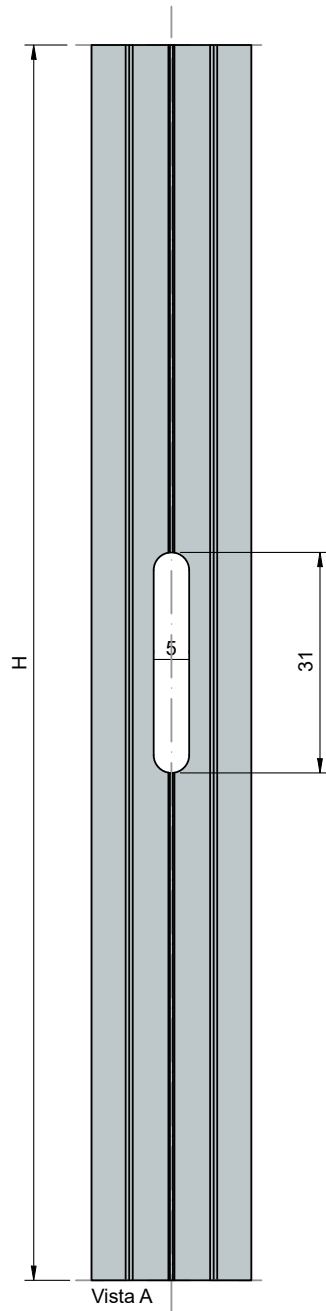
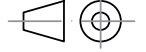

Perfil:

RE-22027

USI 34

ESCALA 1:1

usinagem marco lateral 2 planos

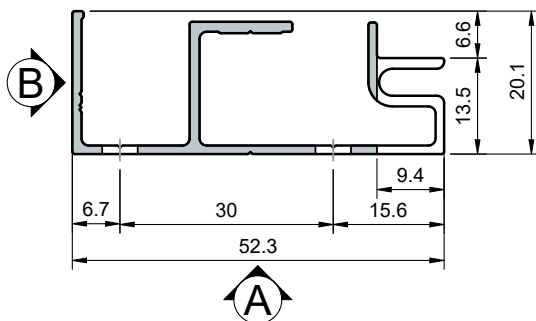
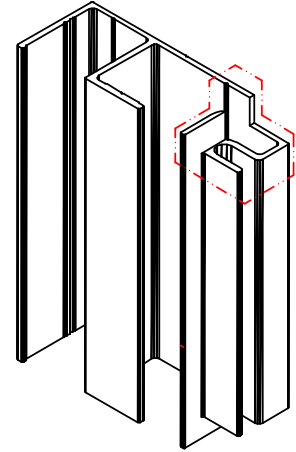
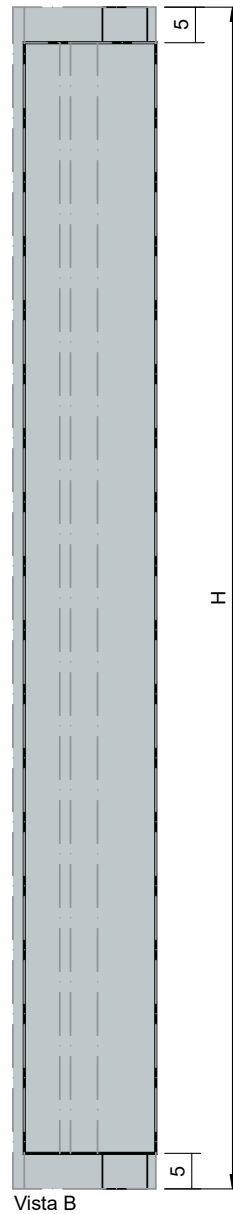
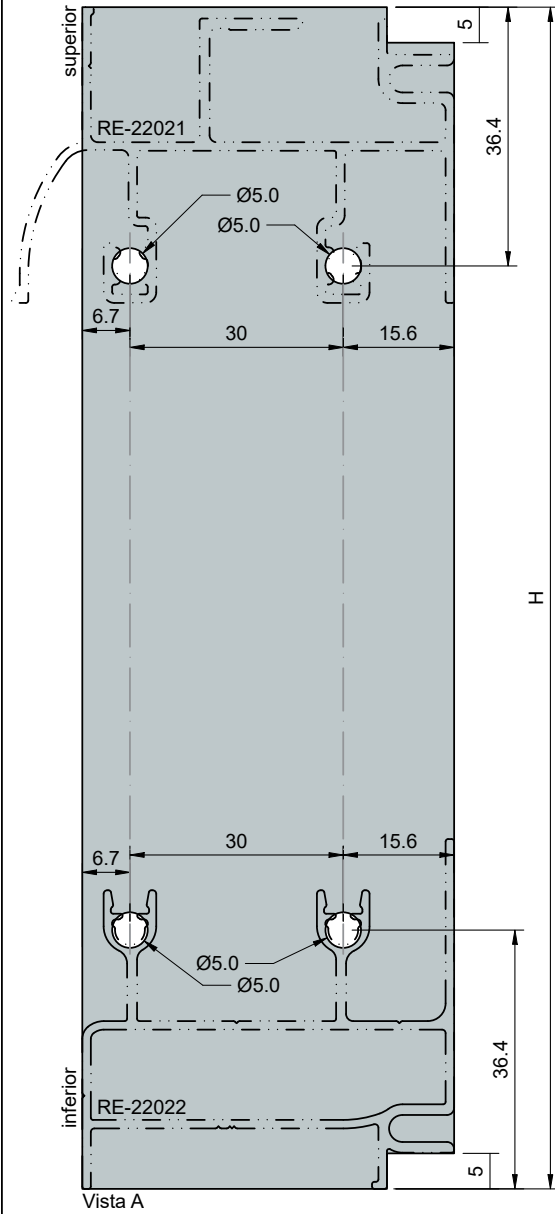
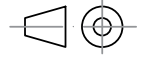

Perfil: **RE-22027**

USI 35

ESCALA 1:1
usinagem marco lateral 2 planos

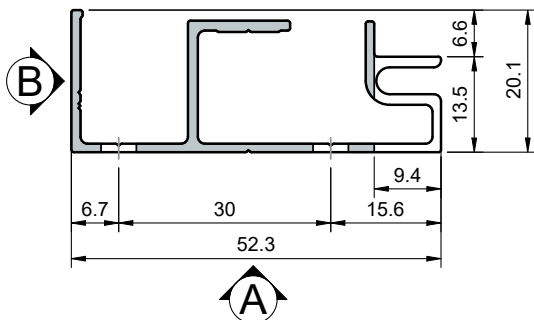
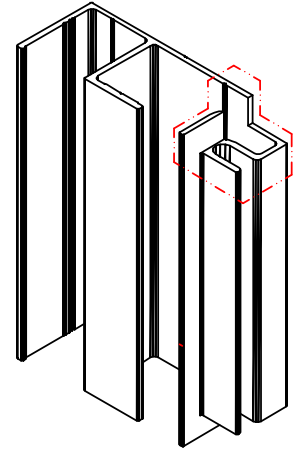
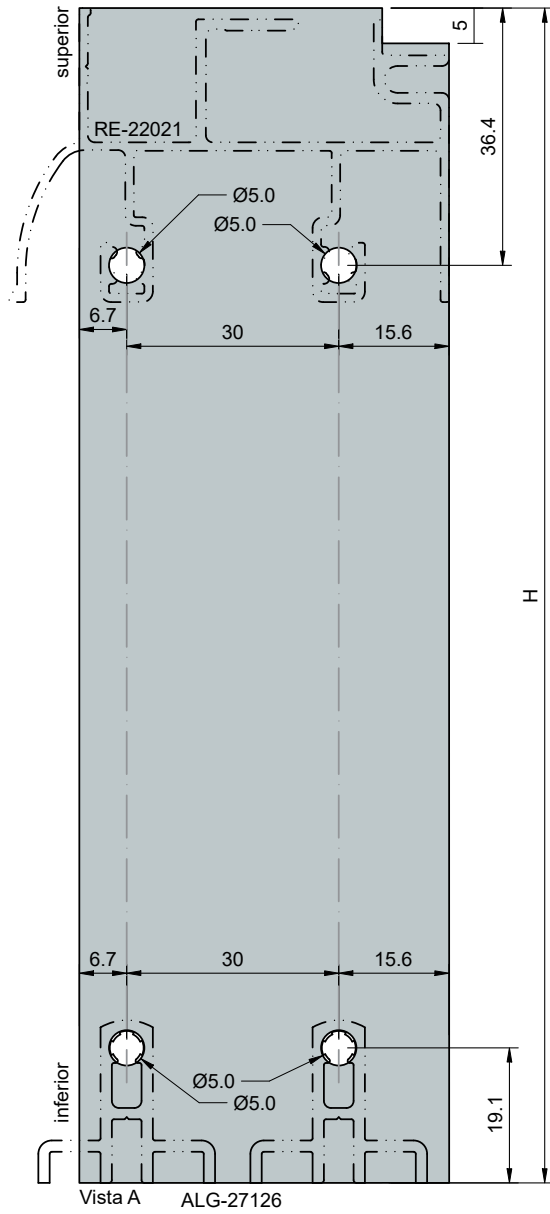
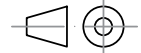



Visite nossas redes sociais



/cdametaisbr



/cdametais



/cdametais

Diadema | SP

Av. Maria Leonor, 1067
Tel.: (11) 4996-7000

Porto Alegre | RS

Av. A. J. Renner, 200
Tel.: (51) 3373-2333

Curitiba | PR

Av. Senador Salgado Filho, 216 C
Tel.: (41) 3063-3000

Camboriú | SC

Rd. BR-101, Km 131, s. 404/405
Tel.: (47) 3514-5806